

















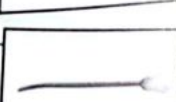









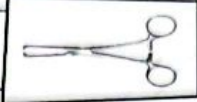

01	Scalpel Handles		01-to-04
02	Diagnostic		05-to-06
03	Anesthesia		07-to-09
04	Scissors		10-to-17
05	Dissecting and Tissue Forceps		18-to-22
06	Artery Forceps		23-to-36
07	Cotton Swap Forceps		37-to-38
08	Probes		39-to-40
09	Bone Surgery		41-to-61
10	Plaster Instruments		62-to-63
11	Suture		64-to-72
12	Neurosurgery		73-to-82
13	Cardiovascular		83-to-110
14	Tonsil		111-to-117
15	Otology		118-to-129



Table of Contents

16	Rhinology		130-to-141
17	Oral instrument		142-to-157
18	Stomach, Intestines, Rectum		158-to-166
19	Kidney, Liver, Gall Stone, Urology		167-to-173
20	Retractor		174-to-193
21	Dermatology		194-to-195
22	Tracheotomy		196-to-198
23	Ophthalmology		199-to-205
24	Gynecology		206-to-217
25	Obstetrics		218-to-221
26	Goitre		222
27	Sterilization		223
28	Asepsis		224
29	Holloware		225-to-229
30	TC Instrument		230-to-244



Section # 1-6

- 01 Scalpel Handles
- 02 Diagnostic
- 03 Anesthesia
- 04 Scissors
- 05 Dissecting and Tissue Forceps
- 06 Artery Forceps



01-101 - Fig. 1 - 3.0cm
 01-102 - Fig. 2 - 3.6cm
 01-103 - Fig. 3 - 4.0cm
 01-104 - Fig. 4 - 4.5cm
 01-105 - Fig. 5 - 5.0cm



01-111 - Fig. 1
 01-112 - Fig. 2
 01-113 - Fig. 3
 01-114 - Fig. 4
 01-115 - Fig. 5
 01-116 - Fig. 6
 01-117 - Fig. 7
 01-118 - Fig. 8
 01-119 - Fig. 9



01-129 - Fig. 1
 01-130 - Fig. 2
 01-131 - Fig. 3
 01-132 - Fig. 4
 01-133 - Fig. 5



Dieffenbach
 13cm
 01-139 - Fig. 1
 01-140 - Fig. 2
 01-141 - Fig. 3
 01-142 - Fig. 4
 01-143 - Fig. 5



Dieffenbach
 13cm
 01-144 - Fig. 1
 01-145 - Fig. 2
 01-146 - Fig. 3
 01-147 - Fig. 4
 01-148 - Fig. 5



01-101-110
 Fig. 1-10

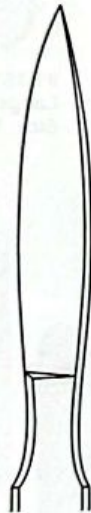

01-106 - Fig. 6 - 2.7cm
 01-107 - Fig. 7 - 3.5cm
 01-108 - Fig. 8 - 4.0cm
 01-109 - Fig. 9 - 4.7cm
 01-110 - Fig. 10 - 5.0cm



01-111 - 01-128
 Size: 14cm - 17.5cm



01-120 - Fig. 11
 01-121 - Fig. 12
 01-122 - Fig. 13
 01-123 - Fig. 14
 01-124 - Fig. 15
 01-125 - Fig. 16
 01-126 - Fig. 17
 01-127 - Fig. 18
 01-128 - Fig. 19



01-129 - 01-138
DIEFFENBACH
 Size: 17cm



01-134 - Fig. 6
 01-135 - Fig. 7
 01-136 - Fig. 8
 01-137 - Fig. 9



01-138 - Fig. 16
Tenotome



01-149 - 01-150
JOSEPH
 Size: 14.5cm
 Double Edged
 Nasal Knives, Pointed



01-149
 Straight



01-150
 Curved



Amputating Knives, Cartilage Knives and Autopsy Knives



Trigeminal & Tonsil Knives, Razor Blade Holders & Breakers Razors and Dermatomes



01-171
Size: 23 cm
Trigeminal Knife

01-172
FOWLER
Size: 20 cm
Tonsil Knife



01-174
ABRAHAM
Size: 21.5 cm
Tonsil Knife



01-173
BRUENINGS
Size: 21.5 cm
Tonsil Knife



01-175
OLIVECRONA
Size: 20.5 cm
Trigeminal Knife



01-176
TROUTMAN-CHRIS
Size: 9.0 cm
Handle Diameter 5.5mm



01-177
TROUTMAN-CHRIS
Size: 9.0 cm
Handle Diameter 5.5mm



01-178
Razor Blades
breakable
package with 10 units



01-179
CASTROVIEJO
Size: 13 cm
Handle Diameter 5.5mm



01-180-SCHINK
Size: 31cm
Complete with 2 skin fixing
plates and 1 blade. Adjustable
from 0.1 to 2.0mm

01-181
SCHINK
Spare Blade



01-182-SILVER
Size: 19 cm
For Usual
Razor Blades

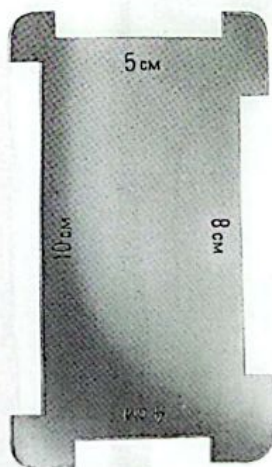

01-183
SCHINK
Skin Fixing Plate



01-184
Size: 7.5 cm
Cutting Length



01-185
Size: 8.0 cm
Cutting Length

Scalpel Handles



01-186
STANDARD
No. 4
Solid

01-187
Double Handle
No. 4 + No. 3
Solid

01-188
No. 4 L
Straight
Solid

01-189
No. 4 L
Solid Angled

01-190
COLLIN
No. 8
Hollow

01-191
COLLIN
No. 9
Hollow

01-192
16 cm
1.5/2.0mm

01-193
No. 3, Straight
Solid, Round
Size:14.5cm

01-194
No. 3
Angled
Solid,
Round
Size:14cm

01-195
Swivelhead
15.5 cm



01-197
STANDARD
No. 3
Solid
Size:12cm

01-198
No. 3
Solid
Size:12cm
solid handle
style as
No.4

01-199
No. 3
Solid
Size:12cm
cm-graduation

01-200
No. 3 L
Straight
Solid, long
Size:21.5cm

01-201
No. 3 L
Angled
Solid, long
Size:21cm

01-202
No. 5

01-203
No. 7
Solid
Size:16cm

01-204
No. 7 K
Solid, short
Size:12.5cm

01-205
No.3
Size:15.5cm
with round
hollow handle

0
B
ty
w
&



Percussion Hammers

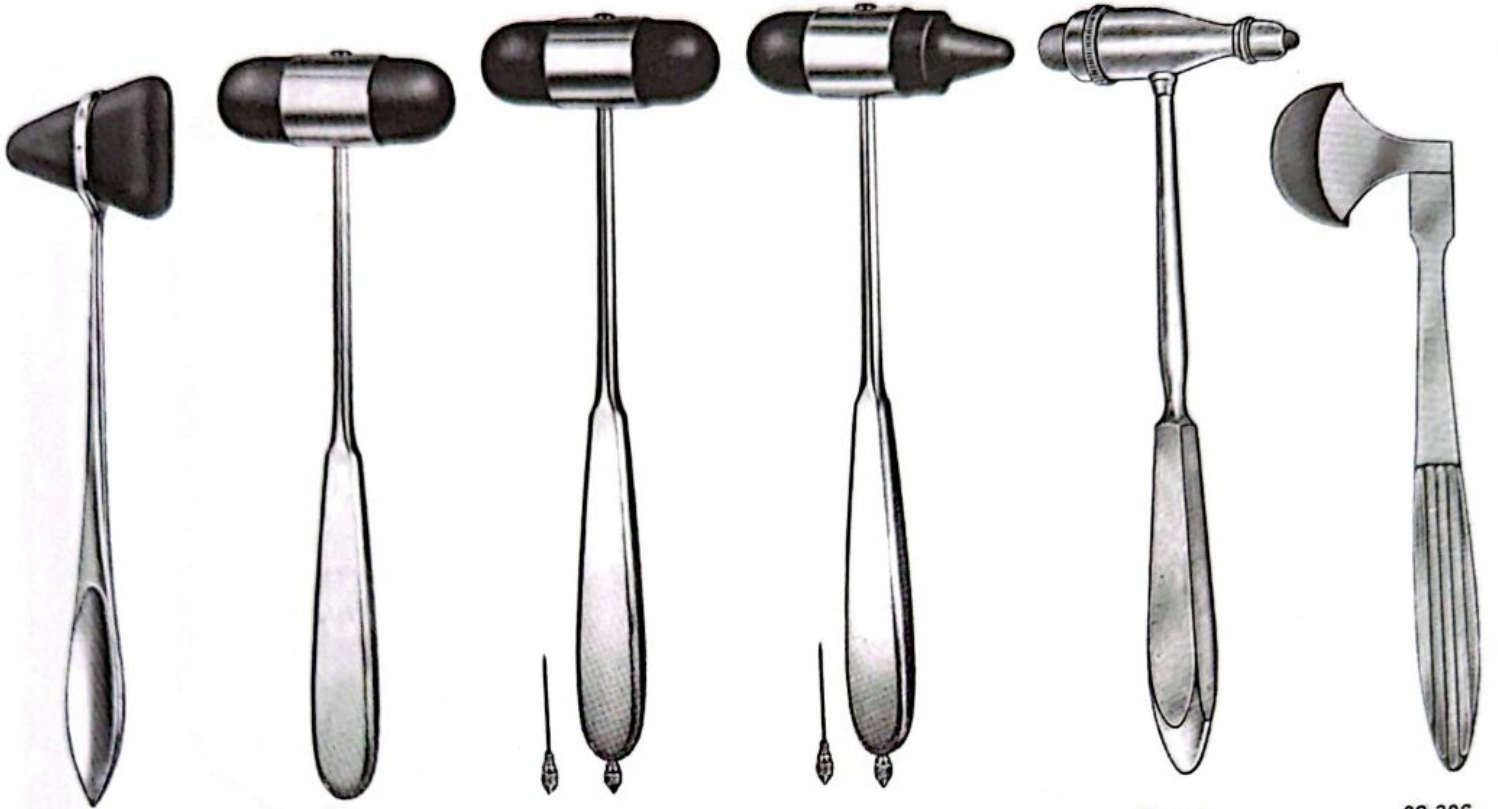

02-301
TAYLOR
Size: 18 cm

02-302
DEJERINE
Size: 20 cm

02-303
DEJERINE
with needle
Size: 21 cm

02-304
DEJERINE
with needle
Size: 210 mm

02-305
TROEMNER
Size: 24 cm

02-306
BERLINE
Size: 17 c



02-307
BUCK
with needle
and brush
Size: 18 cm

02-308
BUCK (Telescopic)
with needle
and brush
Size: 18 cm

02-309
BABINSKY
Size: 23 cm

02-310
RABINER
with needle
and brush
Size: 23 cm

02-311
National Hospital
Size: 33 cm

02-312
Queen
Size: 26



Calipers, Dynamometers, Flexometer and Stethoscopes



02-313
ALY
Size: 17 cm

02-314
WARTENBERG
Pinwheel For
Neurological
Examination
Size: 19 cm



02-315
Pinard
Size: 18 cm
(wooden)



02-316
Pinard
Size: 15 cm
(plastic)



02-317
Pinard
Size: 15 cm
(aluminum)



02-318
Duplex super
lightweight



Ruler
02-319- 15
02-320- 30
02-321- 60

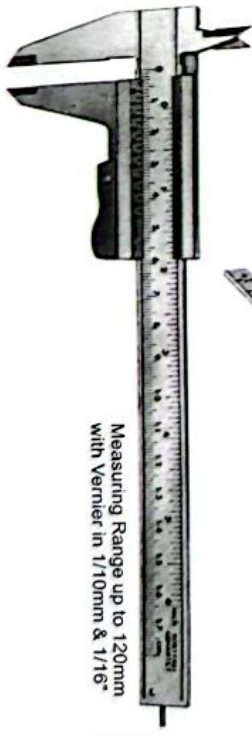

Measuring Range up to 120mm
with Vernier in 1/10mm & 1/16"

02-322
VERNIER Universal
Caliper of Steel
Graduated in mm &
inches up to 180mm



02-323
CARROLL
Size: 145 mm
Finger Goniometer



02-324
TOWNLEY
Graduated in mm
& inches Size: 115 mm



02-325
MOLTGEN
Goniometer



02-326
COLLIN Druck
Pressure 72 kg
Size: 12.5 cm



02-327
CASTROVIEJO
Caliper
Size: 7.5 cm



02-328
BERTILLON Caliper
For Measuring The Head
Size: 32 cm



02-329
Weber- 9cm



Diagnostic Sets



03-402
Otoscope



03-406
Otoscope & Pouch



03-407
Infants
Size: 15 cm

03-408
Children
Size: 20 cm

03-409
Adults
Size: 25 cm



03-407 - 03-409
MAGILL
Catheter Introducing
Forceps



Ear Specula
Dia 3.0mm, 4.0mm
5.0mm



03-404
Spare bulb
2.7 volt, for
otoscopes



03-405
Spare bulb
2.6 volt, for
ophthalmoscopes



03-401
Ophthalmoscope



03-403
Medium battery
handle only,
25 mm diam.

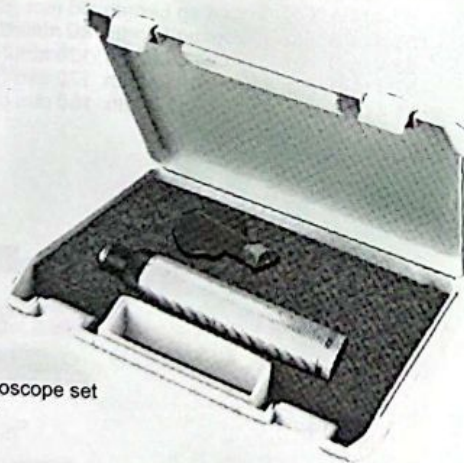

03-410
Ophthalmoscope set
in Case

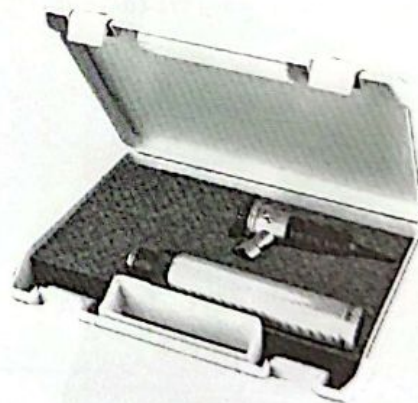

03-411
Otoscope set in Case

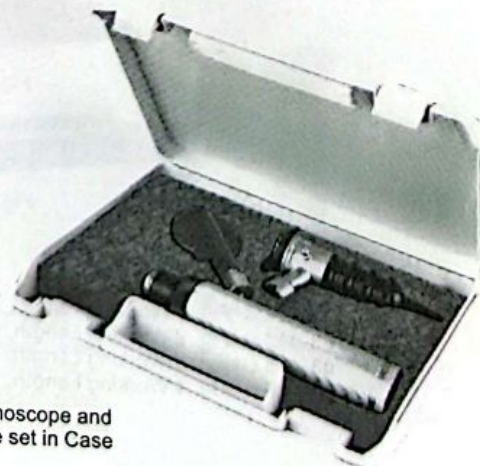

03-412
Ophthalmoscope and
Otoscope set in Case

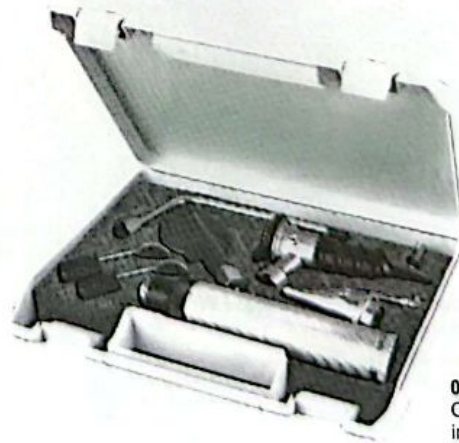

03-413
Complete ENT set
in Case



Laryngoscopes



03-414
MILLER
Laryngoscope Set, Consists Of Battery Handle (Without Battery)
With Five Miller Laryngoscope Blades, Fig 1 to 5

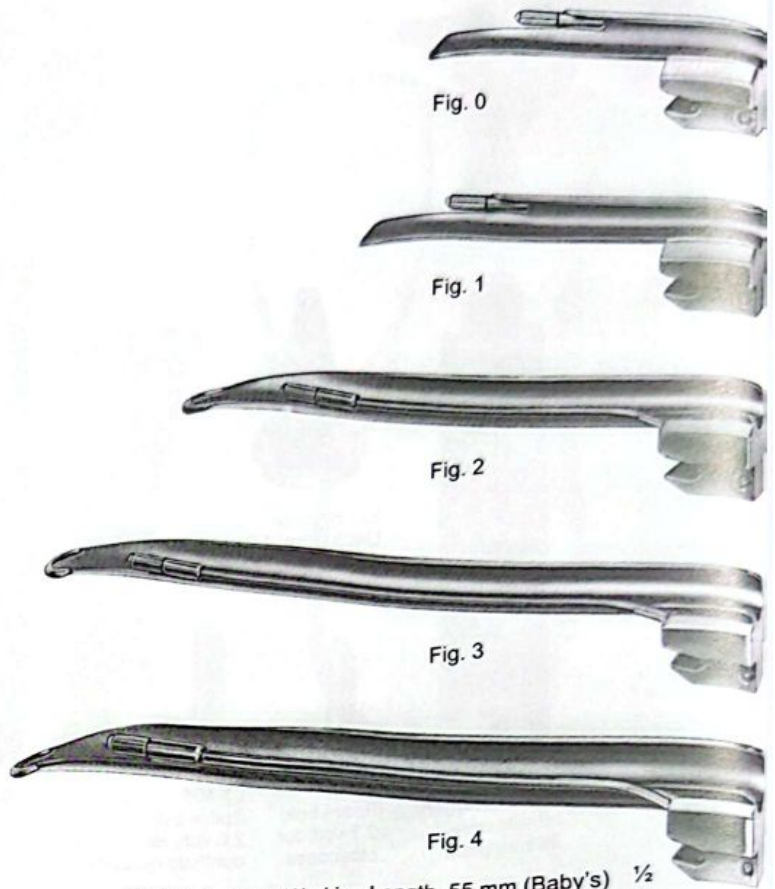

03-414 A Fig. 0 Working Length, 55 mm (Baby's) $\frac{1}{2}$
03-414 B Fig. 1 Working Length, 80 mm (Children's)
03-414 C Fig. 2 Working Length, 130 mm (Adolescent's)
03-414 D Fig. 3 Working Length, 170 mm (Women's)
03-414 E Fig. 4 Working Length, 180 mm (Men's)



03-415
GUEDEL-NEGUS
Laryngoscope Set, Consists Of Battery Handle (Without Battery)
With Four Miller Laryngoscope Blades

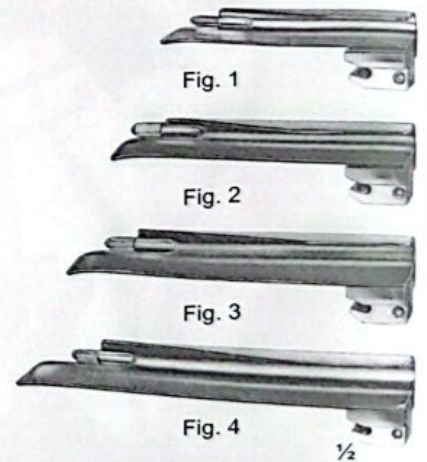

03-415 A Fig. 1 Working Length, 70 mm (Children's)
03-415 B Fig. 2 Working Length, 90 mm (Adolescent's)
03-415 C Fig. 3 Working Length, 110 mm (Women's)
03-415 D Fig. 4 Working Length, 135 mm (Men's)

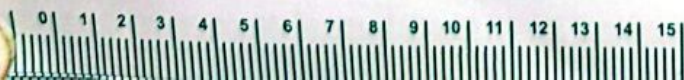

Laryngoscopes



03-416
McINTOSH
Laryngoscope Set, Consists Of Battery Handle (Without Battery)
With Three McIntosh Blades, Fig. 1, Fig. 2, Fig. 3

03-417
McINTOSH
Laryngoscope Set, Consists Of Battery Handle (Without Battery)
With Five McIntosh Blades, Fig. 0, Fig. 1, Fig. 2, Fig. 3, Fig. 4

03-418
FOREGGER
Laryngoscope Set, Consists Of
Battery Handle (Without Battery)
With Three Foregger Blades,
Fig. 1, Fig. 2, Fig. 3,

03-419
FOREGGER
Laryngoscope Set, Consists Of
Battery Handle (Without Battery)
With Four Foregger Blades,
Fig. 1, Fig. 2, Fig. 3, Fig. 4,

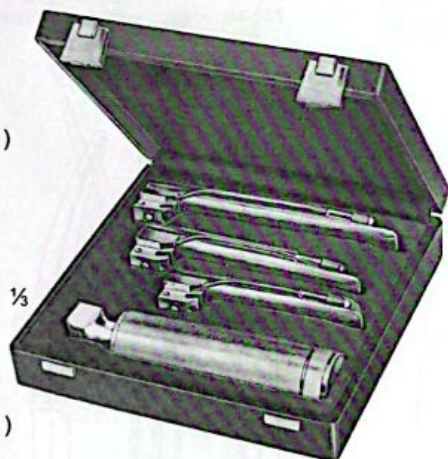

Fig. 0



Fig. 1



Fig. 2



Fig. 3



Fig. 4

03-417 A Fig. 0 Working Length, 55 mm (Baby's)
03-417 B Fig. 1 Working Length, 75 mm (Children's)
03-417 C Fig. 2 Working Length, 90 mm (Adolescent's)
03-417 D Fig. 3 Working Length, 110 mm (Women's)
03-417 E Fig. 4 Working Length, 135 mm (Men's)



Fig. 1



Fig. 2



Fig. 3

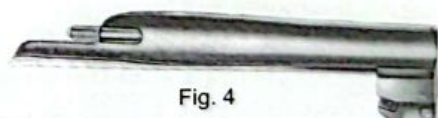

Fig. 4

03-419 A Fig. 1 Working Length, 70 mm (Children's)
03-419 B Fig. 2 Working Length, 90 mm (Adolescent's)
03-419 C Fig. 3 Working Length, 110 mm (Women's)
03-419 D Fig. 4 Working Length, 135 mm (Men's)



03-420
Fiber Optic
Battery Handle
30mm diam.



03-421
Fiber Optic
Battery Handle
18mm diam.



03-422
Replacement Lamp
(Krypton) 2.5 V



03-423
Replacement Lamp
(Halogen) 2.5 V



Operating Scissors

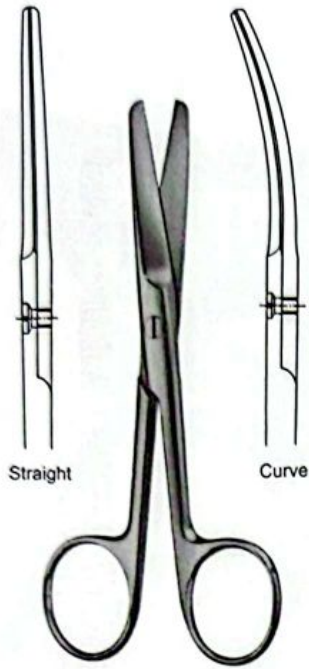

STANDARD (blunt/blunt)

- 04-501 (10.5 cm)
- 04-502 (11.5 cm)
- 04-503 (13.0 cm)
- 04-504 (14.5 cm)
- 04-505 (15.5 cm)
- 04-506 (16.5 cm)
- 04-507 (17.5 cm)
- 04-508 (18.5 cm)
- 04-509 (20.0 cm)

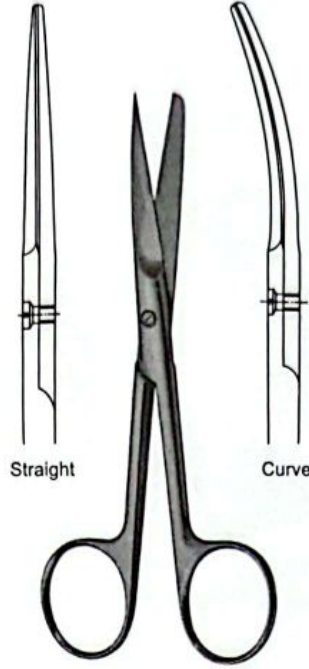

STANDARD (sharp/blunt)

- 04-510 (10.5 cm)
- 04-511 (11.5 cm)
- 04-512 (13.0 cm)
- 04-513 (14.5 cm)
- 04-514 (15.5 cm)
- 04-515 (16.5 cm)
- 04-516 (17.5 cm)
- 04-517 (18.5 cm)
- 04-518 (20.0 cm)

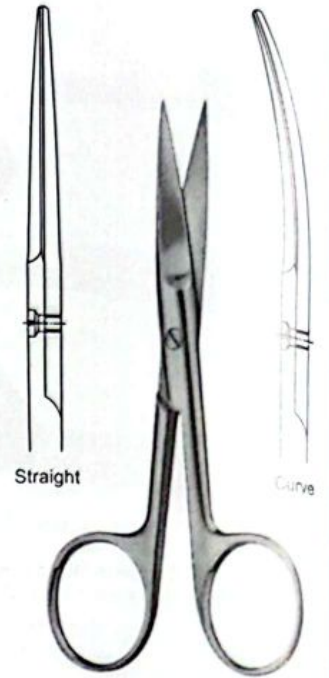

STANDARD (sharp/sharp)

- 04-519 (10.5 cm)
- 04-520 (11.5 cm)
- 04-521 (13.0 cm)
- 04-522 (14.5 cm)
- 04-523 (15.5 cm)
- 04-524 (16.5 cm)
- 04-525 (17.5 cm)
- 04-526 (18.5 cm)
- 04-527 (20.0 cm)



INCISION SCISSOR
04-528 - 14.5 cm

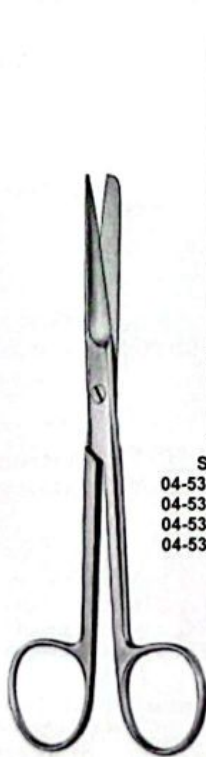

DEAVER
04-529 - 14 cm
04-530 - 14.5 cm

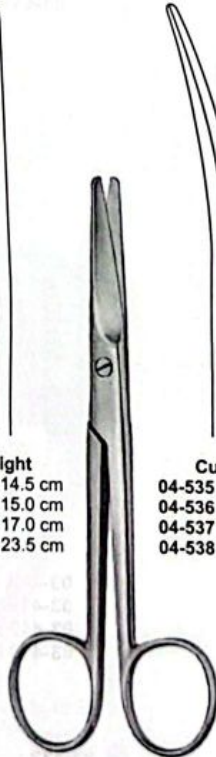

MAYO
04-535 - 04-538

- Straight**
- 04-531 - 14.5 cm
 - 04-532 - 15.0 cm
 - 04-533 - 17.0 cm
 - 04-534 - 23.5 cm

- Curved**
- 04-535 - 14.5 cm
 - 04-536 - 15.0 cm
 - 04-537 - 17.0 cm
 - 04-538 - 23.5 cm

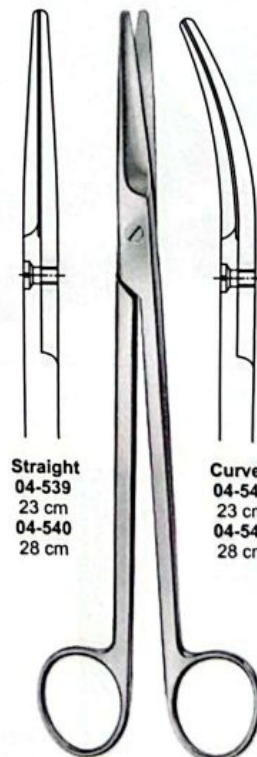

MAYO-HARRINGTON
04-539 - 04-542

- Straight**
- 04-539 - 23 cm
 - 04-540 - 28 cm

- Curved**
- 04-541 - 23 cm
 - 04-542 - 28 cm

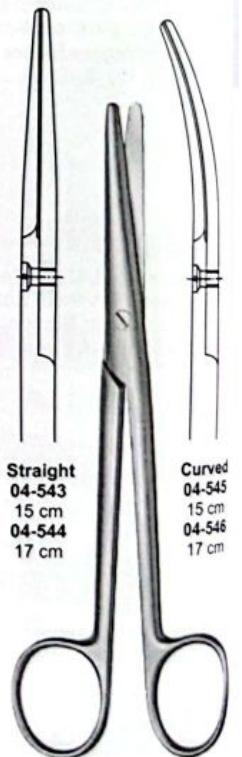

MAYO-STILLE
04-543 - 04-546

- Straight**
- 04-543 - 15 cm
 - 04-544 - 17 cm

- Curved**
- 04-545 - 15 cm
 - 04-546 - 17 cm



Operating Scissors



Mayo-Noble
04-547 - 16.5 cm

Sims
04-548 - 20 cm-Str
04-549 - 23 cm-Cvd

Kelly
04-550 - 16 cm-Str
04-551 - 16 cm-Cvd

Doyen
04-552 - 18.5 cm-Str
04-553 - 18.5 cm-Cvd

Sims-Siebold
04-554 - 24.5 cm-Str

Sims-Siebold
04-555 - 24.5 cm-Cvd



Straight
(blunt/blunt)
04-558-14.5 cm
(Sharp/blunt)
04-559-14.5 cm
(sharp/sharp)
04-560-14.5 cm

Curved
(blunt/blunt)
04-562-14.5 cm
(Sharp/blunt)
04-563-14.5 cm
(sharp/sharp)
04-564-14.5 cm

Straight
(blunt/blunt)
04-574-14.5 cm
(Sharp/blunt)
04-575-14.5 cm
(sharp/sharp)
04-576-14.5 cm

Curved
(blunt/blunt)
04-577-14.5 cm
(Sharp/blunt)
04-578-14.5 cm
(sharp/sharp)
04-579-14.5 cm

Metzenbaum Baby
04-556 - 11.5 cm-str
04-557 - 11.5 cm-cvd

Metzenbaum
04-561

Metzenbaum
04-565 - 15.5 cm-str
04-566 - 15.5 cm-cvd

Metzenbaum-Nelson (str/cvd)
04-567-18 cm 04-570-26 cm
04-568-20.5 cm 04-571-28.5 cm
04-569-23 cm 04-572-31 cm

Metzenbaum Fino
04-573 - 04-579

Metzenbaum-Fino
04-580-18 cm
04-581-20.5 cm
04-582-23 cm
slender pattern, S-shaped



Operating Scissors

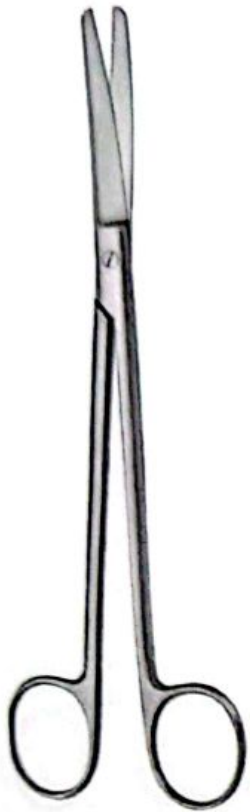

Wertheim
04-583-20 cm
04-584-23 cm



Nerve Dissecting Scissors
04-585-15.5 cm
str / cvd

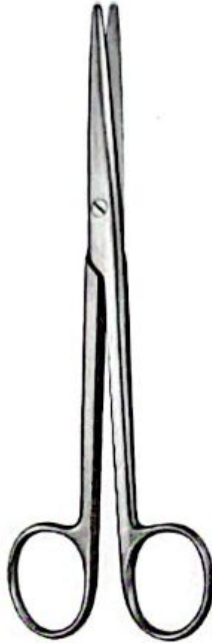

Lexer
04-586-16 cm
04-587-16 cm
str / cvd



Lexer-Baby
04-588-10 cm
04-589-10 cm
str / cvd



Lexer-Fino
04-590-16.5 cm
04-591-16.5 cm
str / cvd



Fomon
04-592-14 cm



Thorek
04-593-14 cm



Cinelli
04-594-11.5 cm

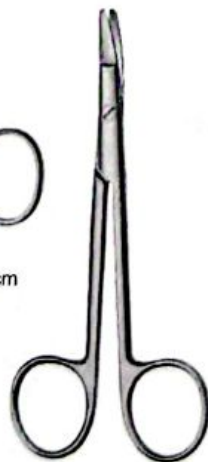

Kilner
04-595-12 cm
04-596-15 cm

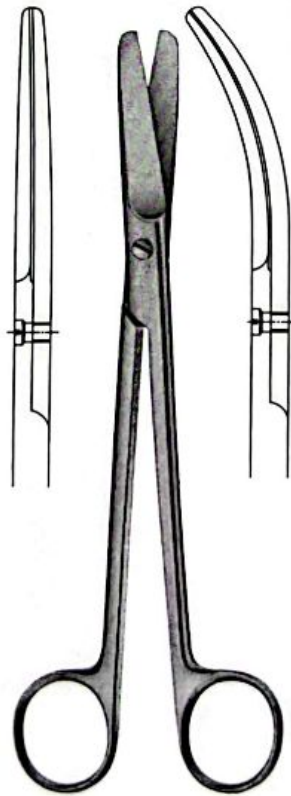

Crafoord
04-597-30 cm



Satinsky
04-598-30 cm



Potts-Smith
04-599 - 04-603
19 cm

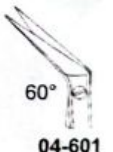

Operating Scissors

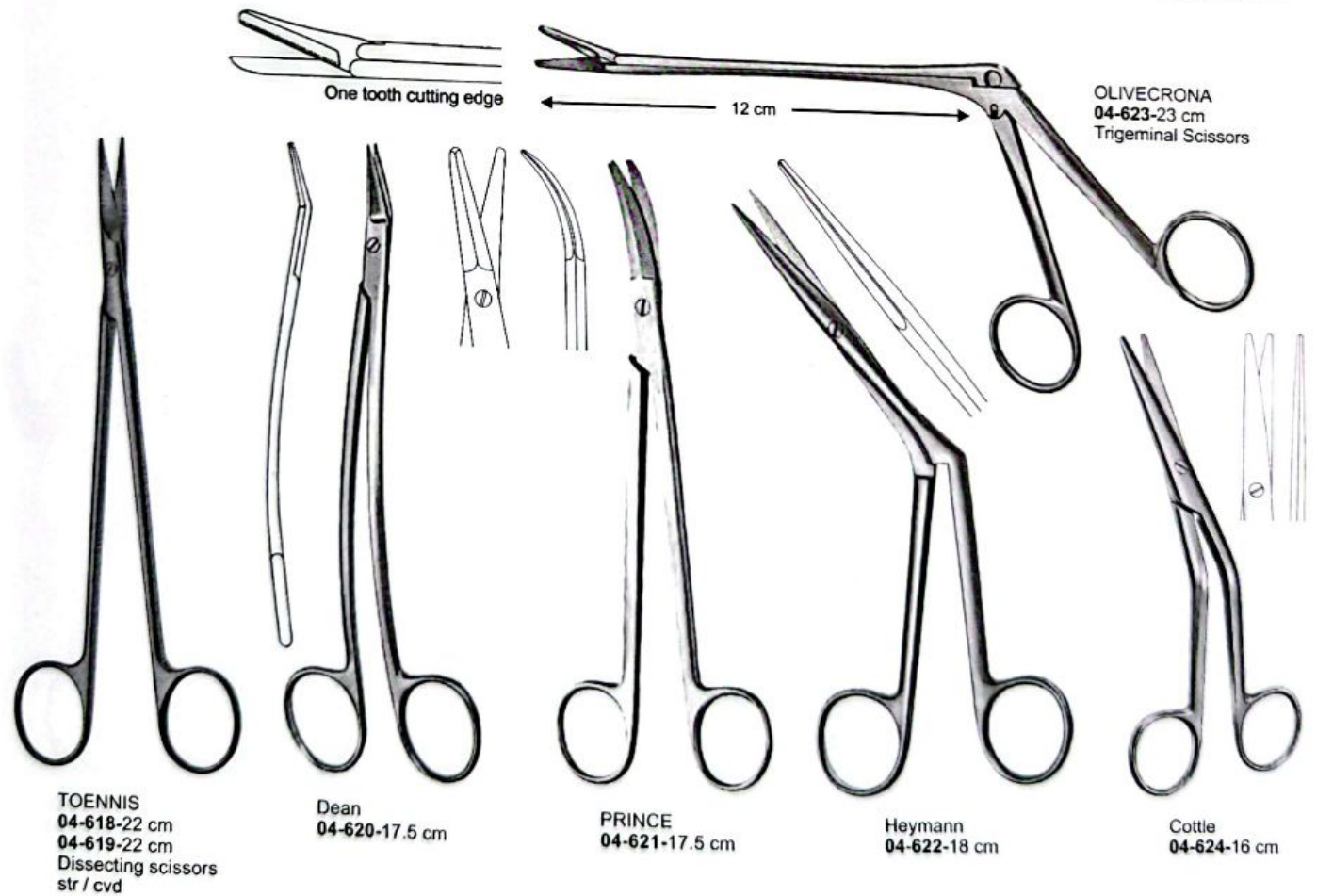
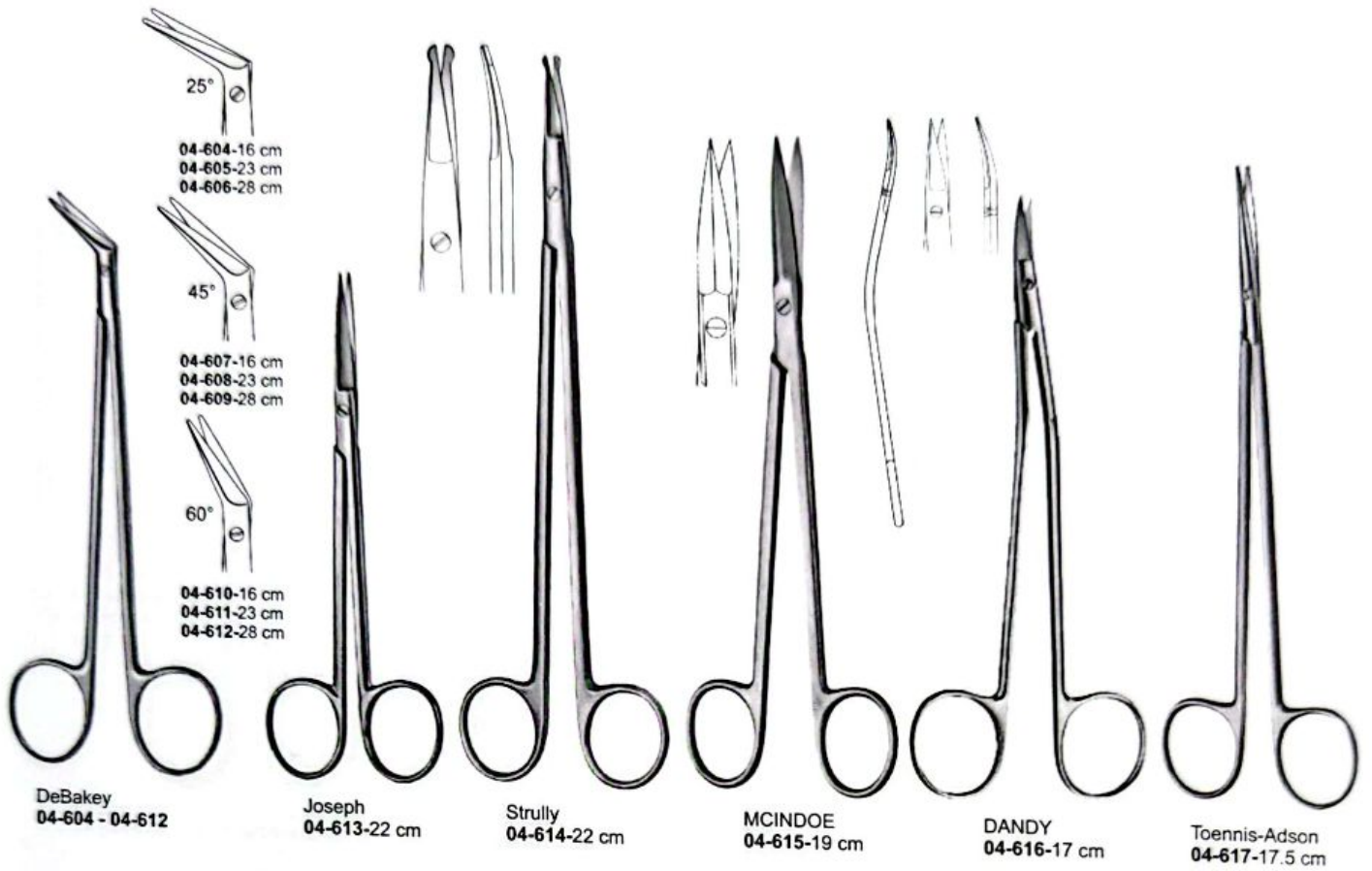

Operating Scissors

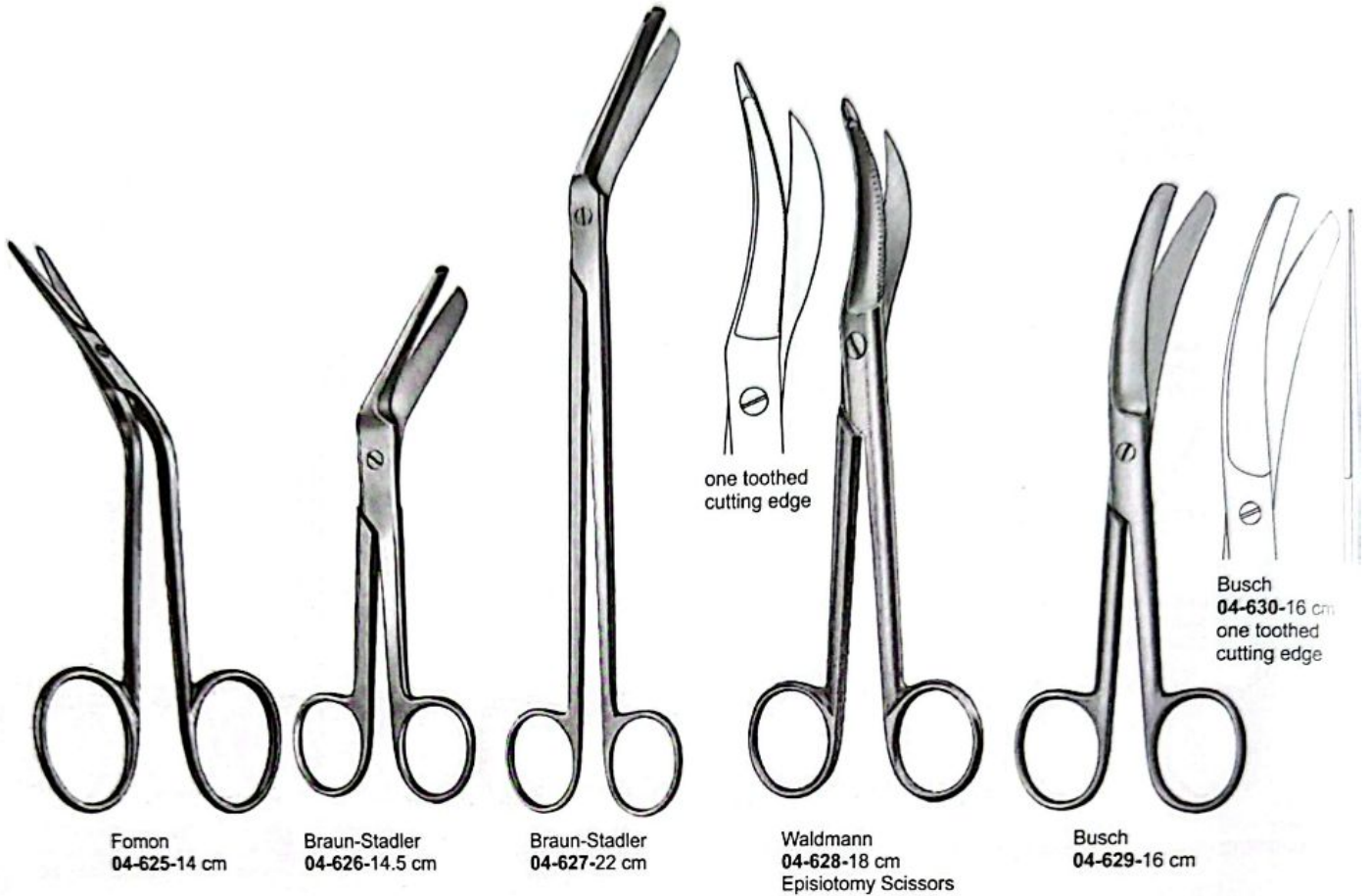

Operating Scissors



Eiselsberg
04-638-12 cm

Northbent
04-639-9 cm
04-640-12.5 cm

Nail Splinting Scissors
04-641-13 cm
04-642-15 cm

Kaye
04-643-18.5 cm
one toothed cutting edge

Aston
04-644-17 cm
one toothed cutting edge

Gorney
04-645-12.5 cm
04-646-19.5 cm
one toothed cutting edge

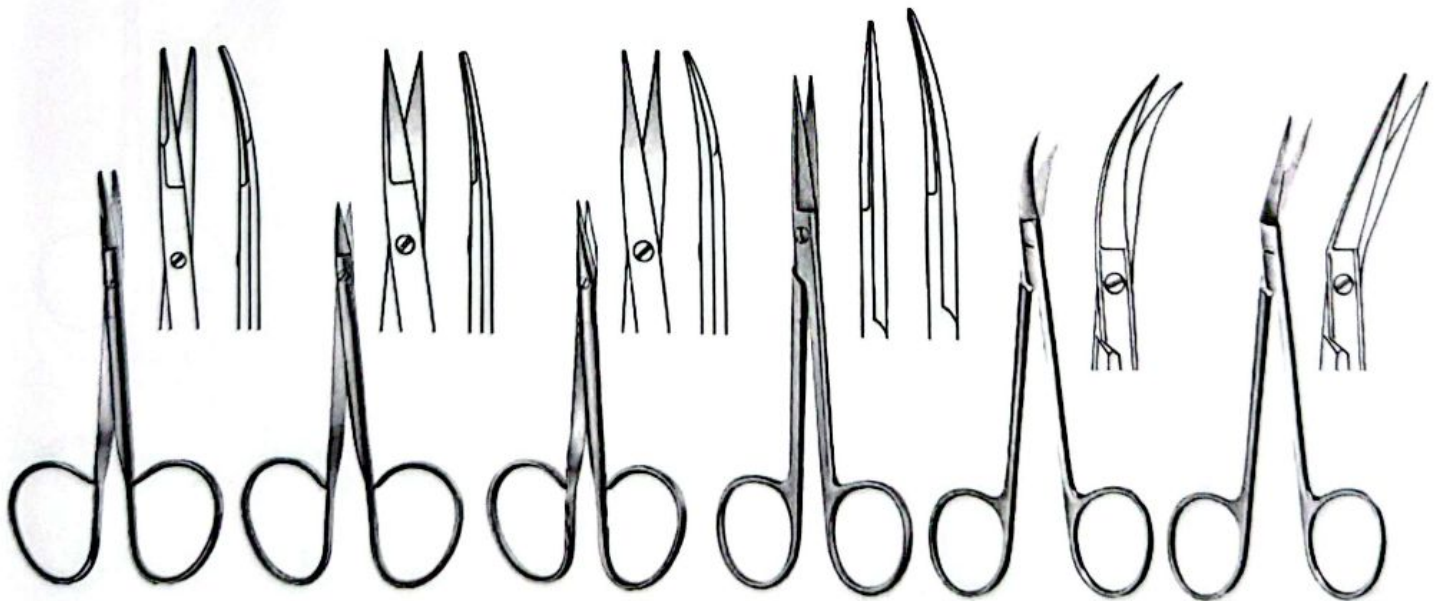

Kaye
04-647-11 cm

Salyer
04-648-9.5 cm

Salyer
04-649-10 cm

Iris Scissors (str/cvd)
04-650-9 cm
04-651-10.5 cm
04-652-11.5 cm

IRIS-FINE
04-653-11.5 cm

IRIS-FINE
04-654-11.5 cm
Angled



Operating Scissors



Operating Scissors

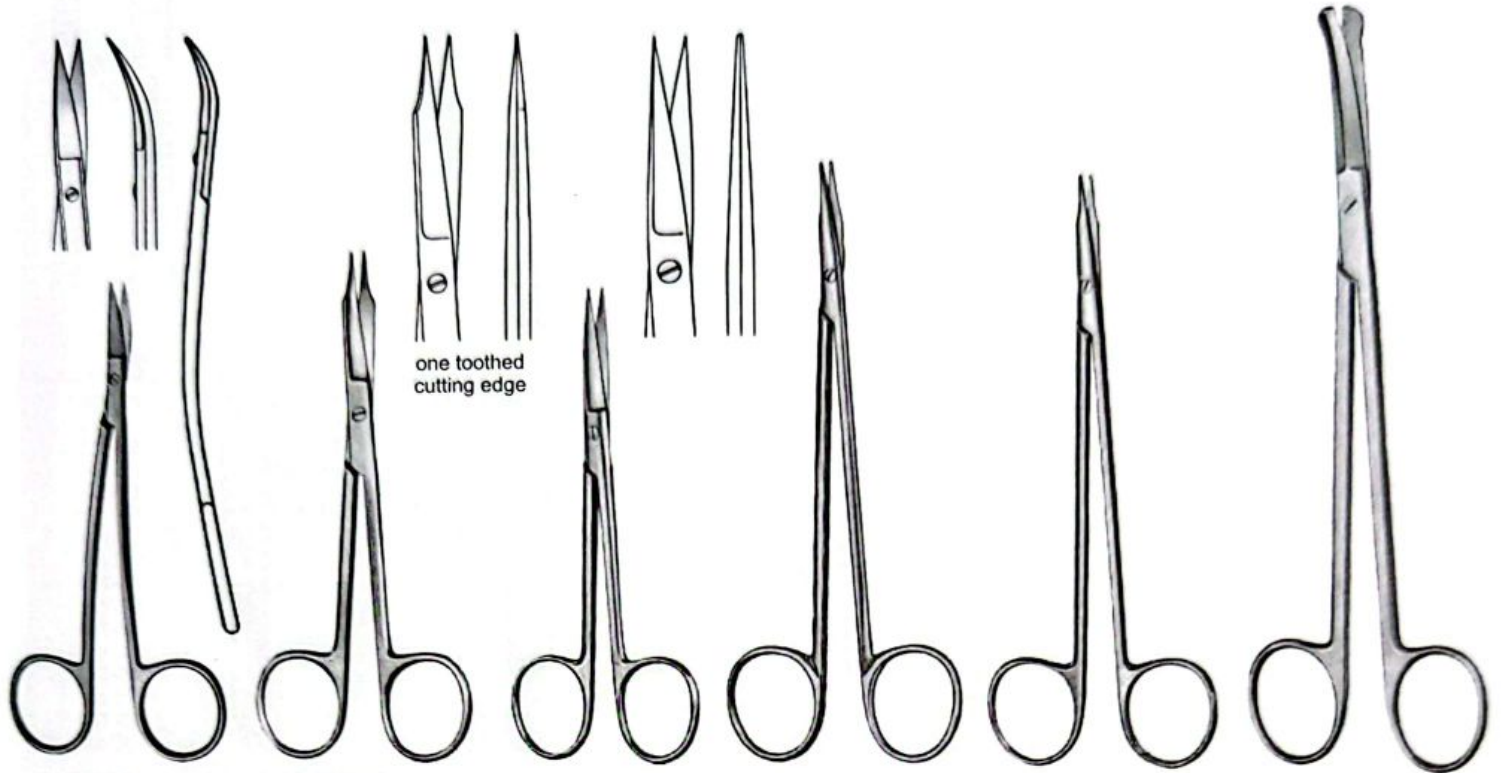

LaGrange
04-669-11.5 cm
S shape

Goldman-Fox
04-670-13 cm
str/cvd

Wagner
04-671-12 cm
str/cvd

Reynolds
04-672-15.5 cm-str
04-673-15.5 cm-cvd
04-674-18 cm-cvd

Jameson
04-675-15.5 cm

Good
04-676-19.5 cm

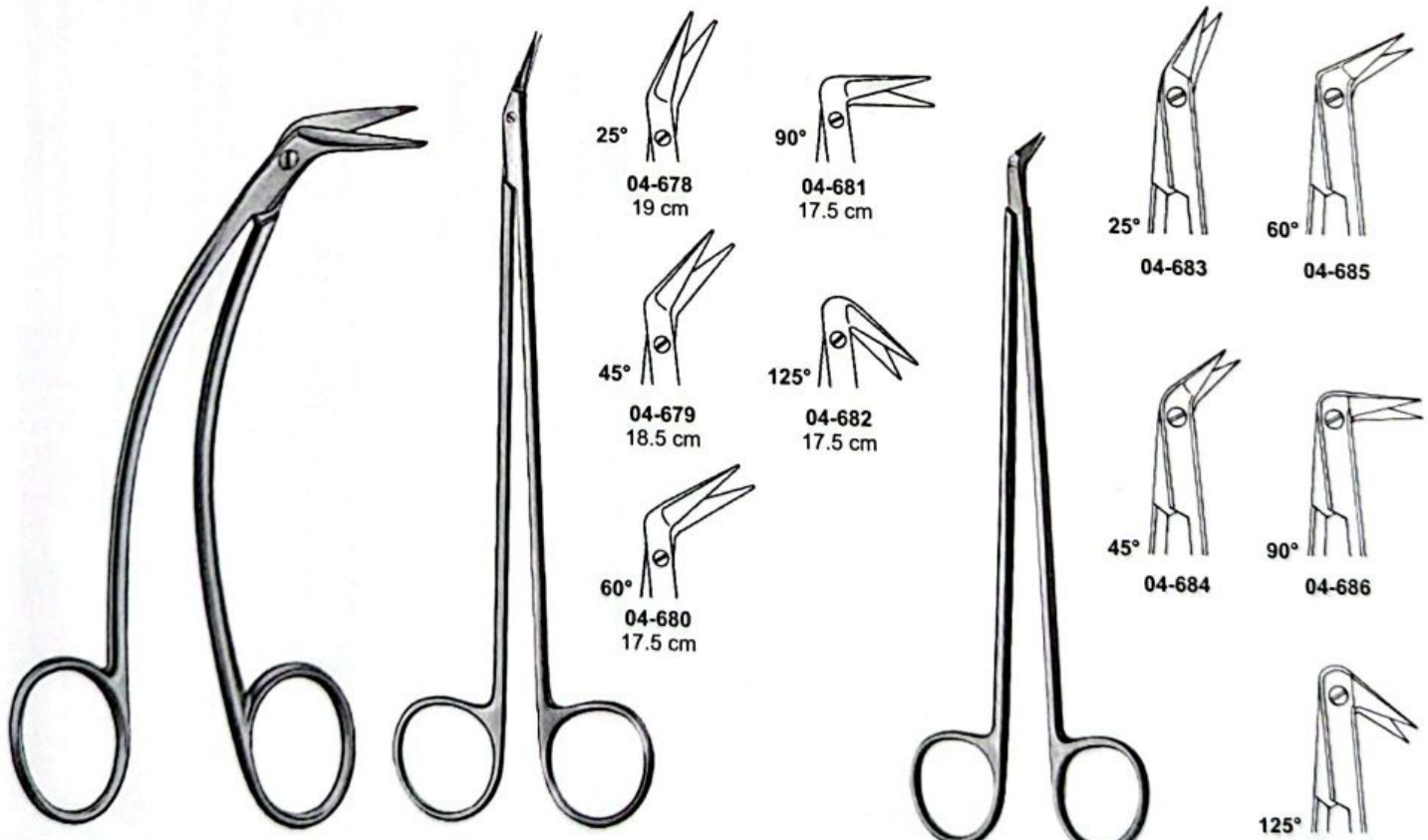

Favaloro
04-677-14.5 cm

Diethrich
04-678 - 04-682

Mikro-Hegemann
04-683 - 04-687
18.5 cm



Dissecting Forceps & Tissue Forceps

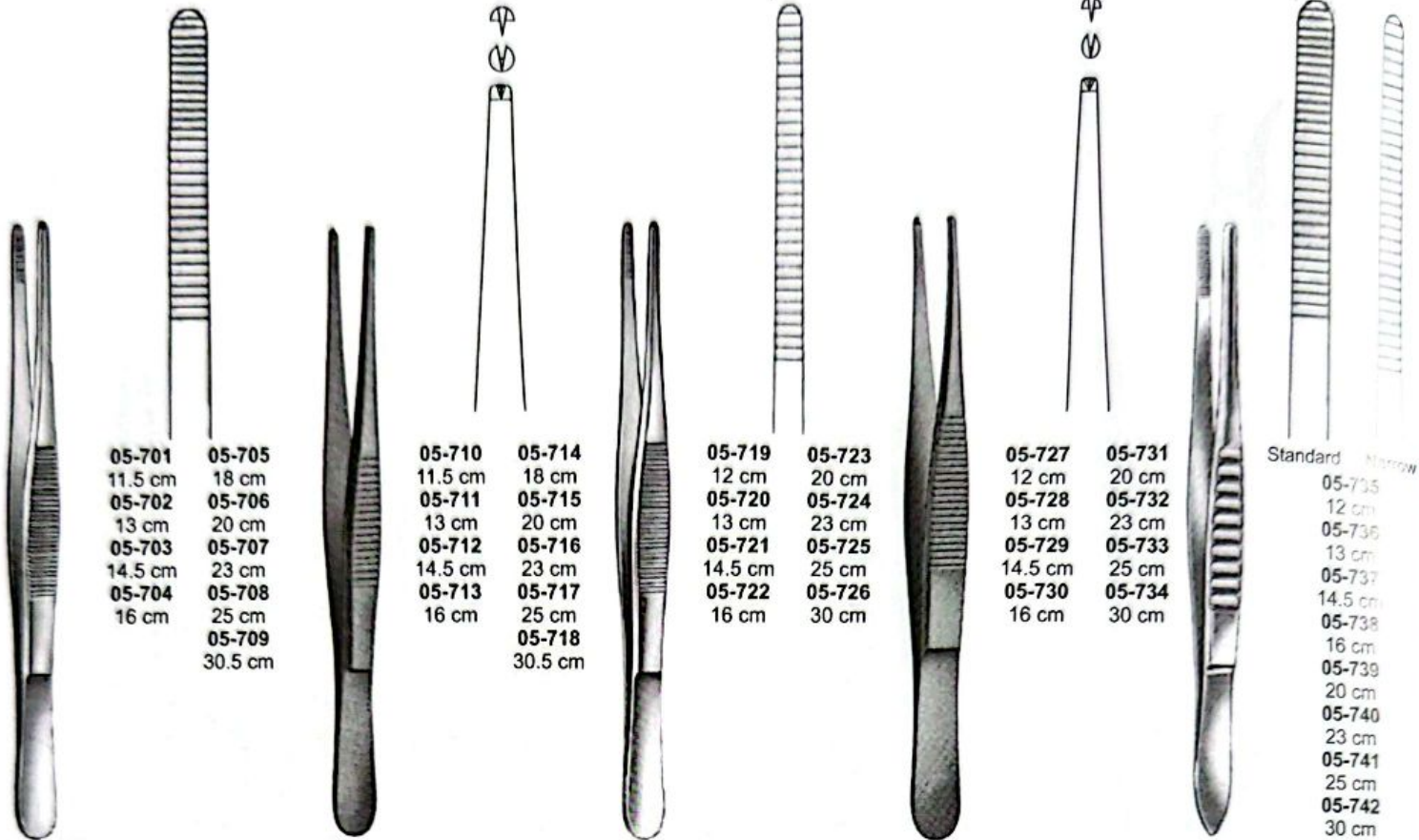

05-701 11.5 cm
05-702 13 cm
05-703 14.5 cm
05-704 16 cm
05-705 18 cm
05-706 20 cm
05-707 23 cm
05-708 25 cm
05-709 30.5 cm

05-710 11.5 cm
05-711 13 cm
05-712 14.5 cm
05-713 16 cm
05-714 18 cm
05-715 20 cm
05-716 23 cm
05-717 25 cm
05-718 30.5 cm

05-719 12 cm
05-720 13 cm
05-721 14.5 cm
05-722 16 cm
05-723 20 cm
05-724 23 cm
05-725 25 cm
05-726 30 cm

05-727 12 cm
05-728 13 cm
05-729 14.5 cm
05-730 16 cm
05-731 20 cm
05-732 23 cm
05-733 25 cm
05-734 30 cm

Standard 05-735 12 cm
Narrow 05-736 13 cm
05-737 14.5 cm
05-738 16 cm
05-739 20 cm
05-740 23 cm
05-741 25 cm
05-742 30 cm

05-701 - 05-709
Dissecting Forcep
Standard Pattern

05-710 - 05-718
Tissue Forcep
Standard Pattern

05-719 - 05-726
Dissecting Forcep
Narrow Point

05-727 - 05-734
Tissue Forcep
Narrow Point

05-735 - 05-742
USA Model
Standard & Narrow Point



05-743
Stille
15 cm

05-744
Stille
15 cm

05-745
15 cm
1x2th

05-746
Ochsner
14 cm

Treves Turn over
05-747-12 cm 05-750-15 cm
05-748-18 cm 05-751-20 cm
05-749-25 cm

Treves Block end
05-752-12 cm 05-755-15 cm
05-753-18 cm 05-756-20 cm
05-754-25 cm

05-757 18 cm
05-758 21 cm
05-759 25 cm
05-760 30 cm

05-757 - 05-760
Potts-Smith

05-761 18 cm
05-762 21 cm
05-763 25 cm
05-764 30 cm

05-761 - 05-764
Potts-Smith

Dissecting Forceps & Tissue Forceps

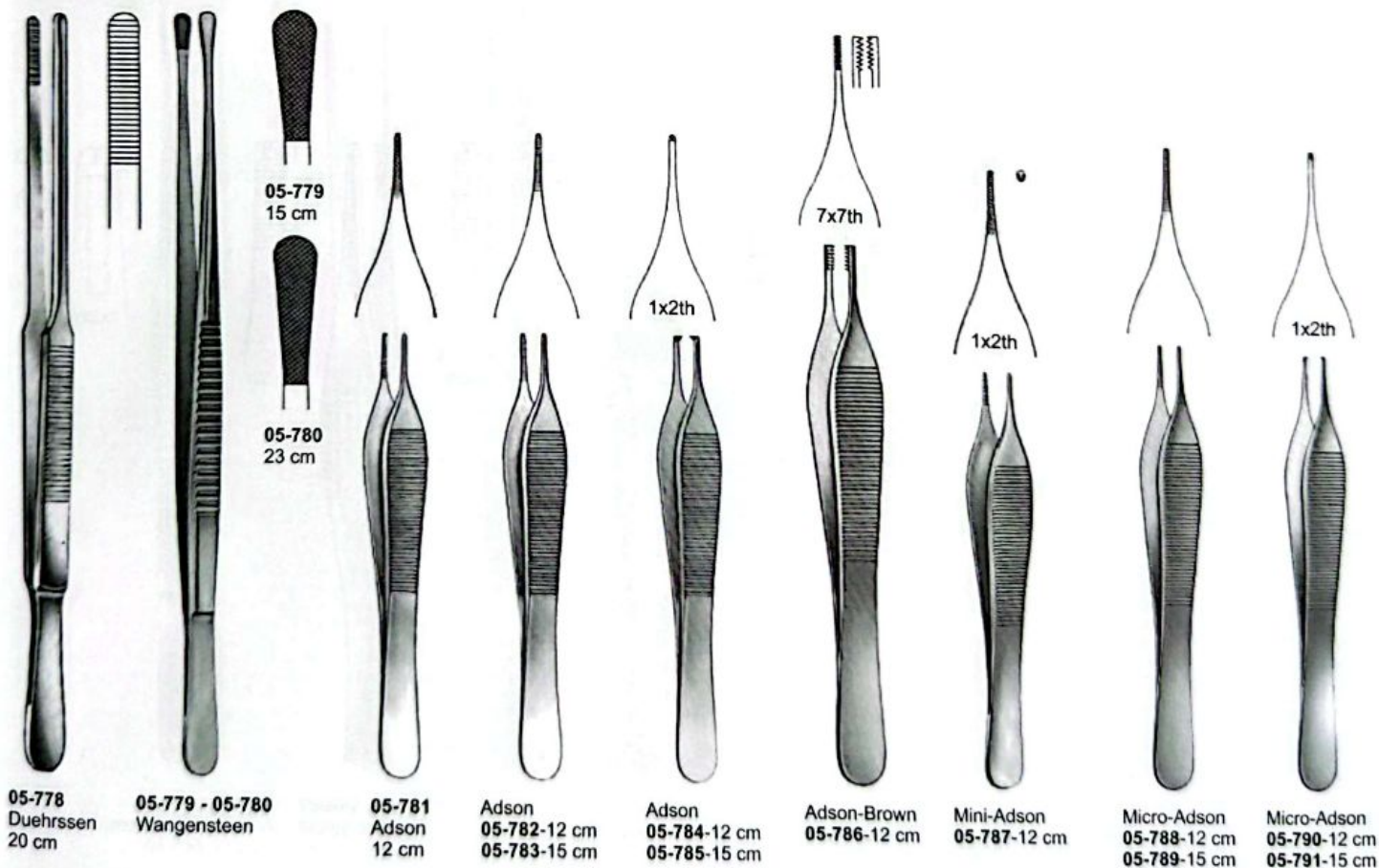
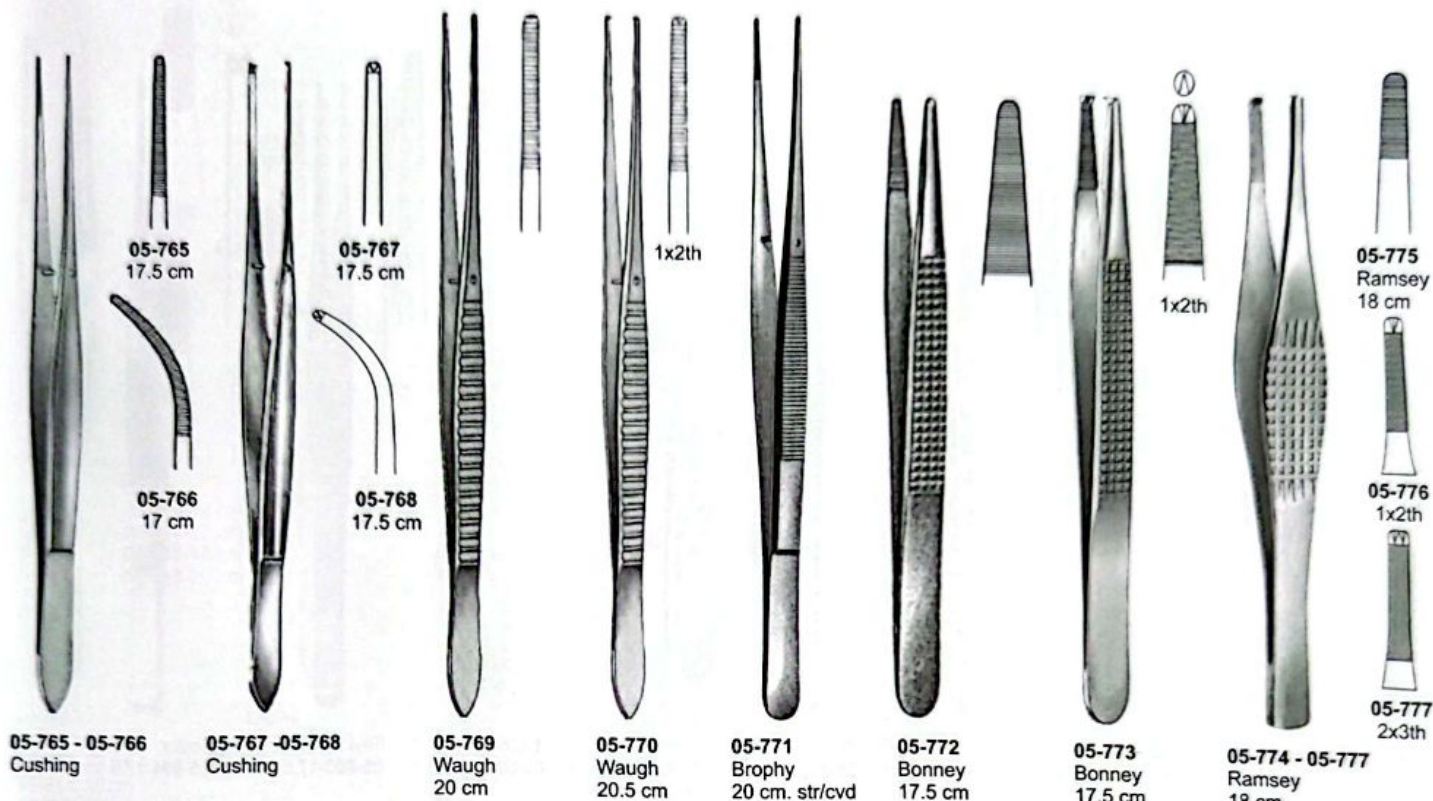

Dissecting Forceps & Tissue Forceps

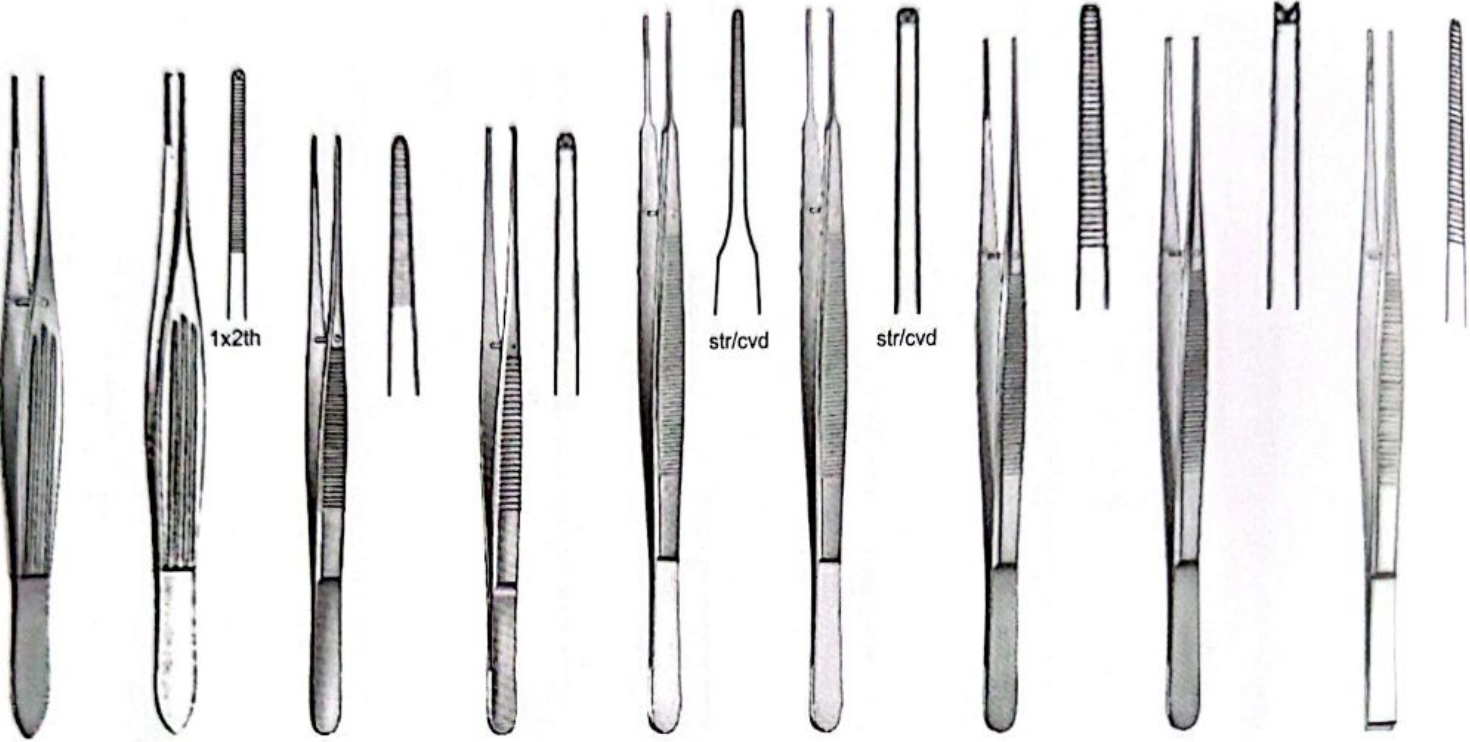

05-792
McIndoe
15 cm

05-793
McIndoe
15 cm

Semken
05-794-12.5 cm
05-795-15 cm

Semken
05-796-12.5 cm
05-797-15 cm

Gerald
05-798-17.5 cm
05-799-17 cm

Gerald
05-800-17.5 cm
05-801-17 cm

Taylor
05-802-17 cm

Taylor
05-803-17.5 cm

Taylor
05-804-17.5 cm

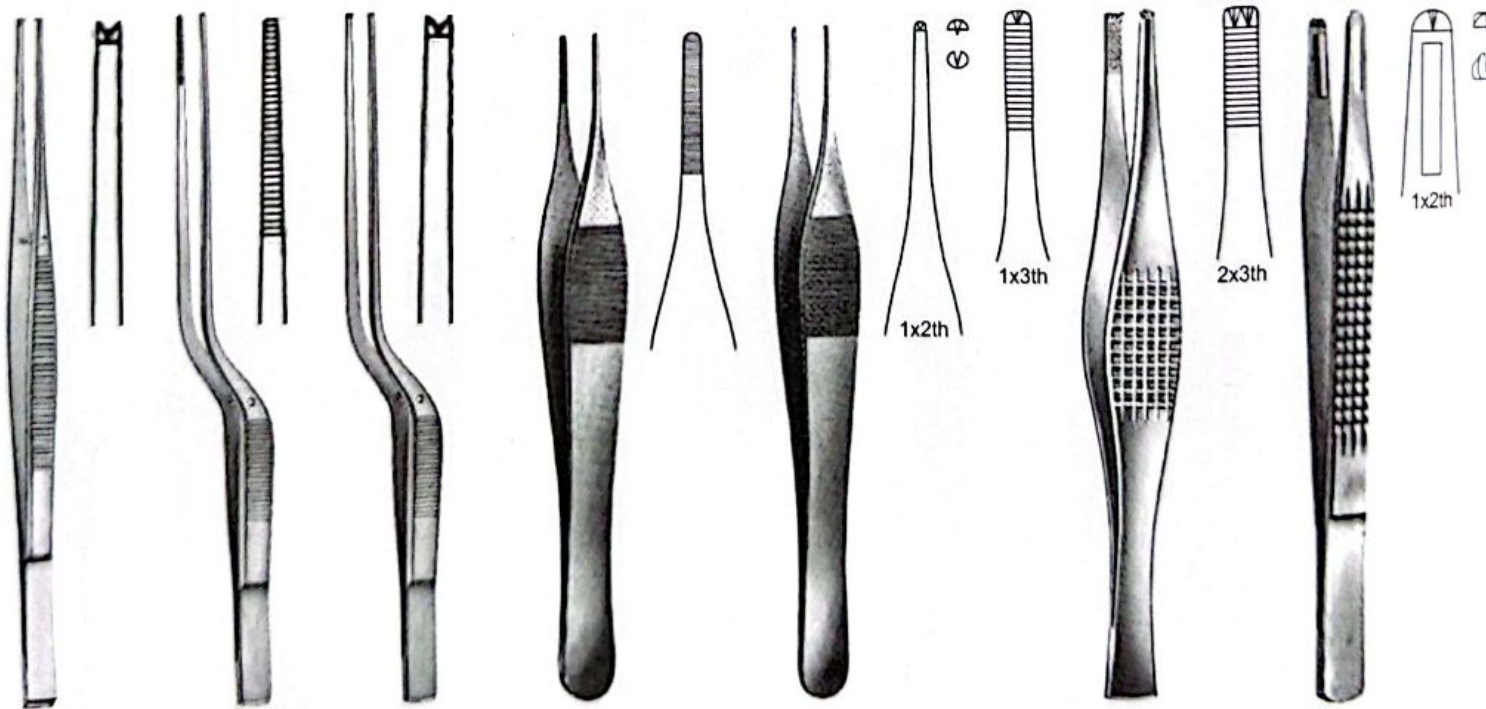

Taylor
05-805-17 cm

Taylor
05-806-18.5 cm

Taylor
05-807-18.5 cm

Jefferson
05-808-18 cm

Jefferson
05-809-18 cm

Ferris Smith
05-810-18 cm

Chamley
05-811-18 cm

Dissecting Forceps & Tissue Forceps

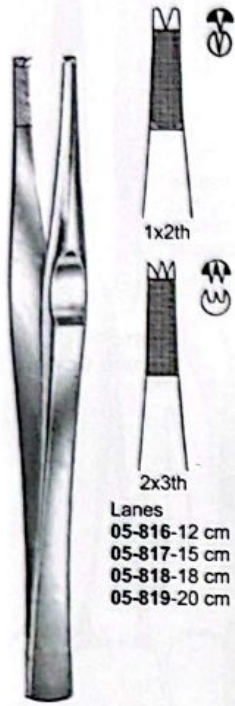

Lanes
05-816-12 cm
05-817-15 cm
05-818-18 cm
05-819-20 cm

Lanes
05-812-12 cm
05-813-15 cm
05-814-18 cm
05-815-20 cm

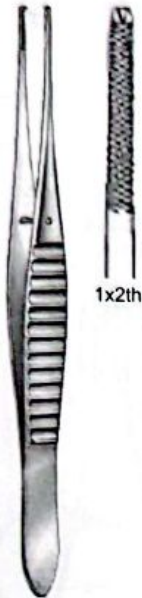

Gillies
05-820-15.5 cm



Brown
05-821-15 cm
05-822-20 cm
05-823-25 cm



Graefe
05-824-10 cm

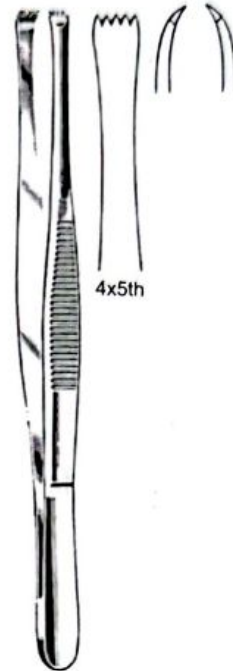

Stone
05-825-15 cm



Lerche
05-826-15 cm



Bickford
05-827-22.5 cm



Bickford
05-828-22.5 cm



Cairns (Dott)
05-829-21.5 cm
05-830-18 cm



05-831
Maingot Intestinal
Serrated - 2.8 cm



05-832
ST Mark
21.9 cm



05-833
EMMET
20 cm



05-834
Silcock
1x2 th / 10 cm



05-835
Canadian
2x3 th / 14 cm



05-836
Officer
4x5th / 15 cm



05-837
Mustarde
Combined, double
hooked jaw, 15 cm



05-838
Jackson
Burrows
1x2th / 15 cm



Lung Dissecting / Cilia / Splinter Forceps



05-840
20 cm
05-841
25 cm

05-839
Russ. Modell
15 cm



05-842
Mayo
23 cm



Singley-Tuttle
05-843-18 cm
05-844-23 cm



05-845
Nelson
7x6th, 23 cm



05-846
Douglas, 9 cm

05-847
Littauer, 8.5 cm



05-848
Beer, 9 cm



05-849
9 cm



05-850
Barraquer, 11 cm



05-851
Douglas, 9 cm



05-852-7.5 cm
05-853-9 cm
05-854-11.5 cm
Feilchenfeld



05-855
Shaaf, 9.5 cm



05-856
10.5 cm



05-857
10.5 cm

05-856 - 05-857
Hunter

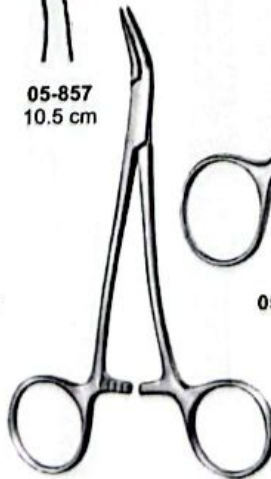

05-858
Peet, 12 cm



05-859
13 cm

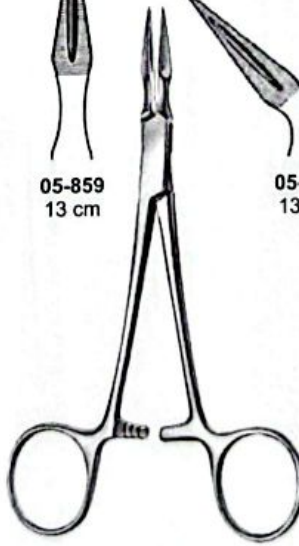

05-859 - 05-860
Stieglitz



05-860
13 cm

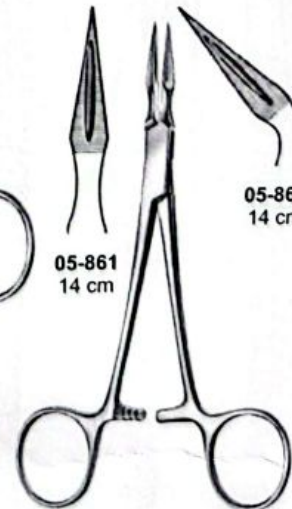

05-861 - 05-862
Arther



05-861
14 cm

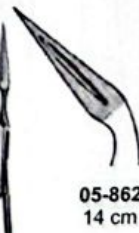

05-862
14 cm



05-863
14 cm

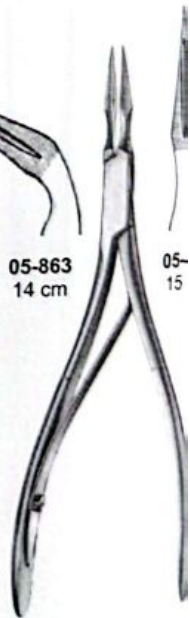

05-863 - 05-864
Ralk

05-15

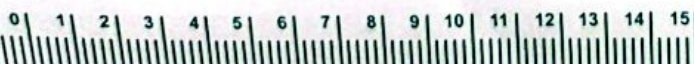

Haemostatic Forceps



Haemostatic Forceps

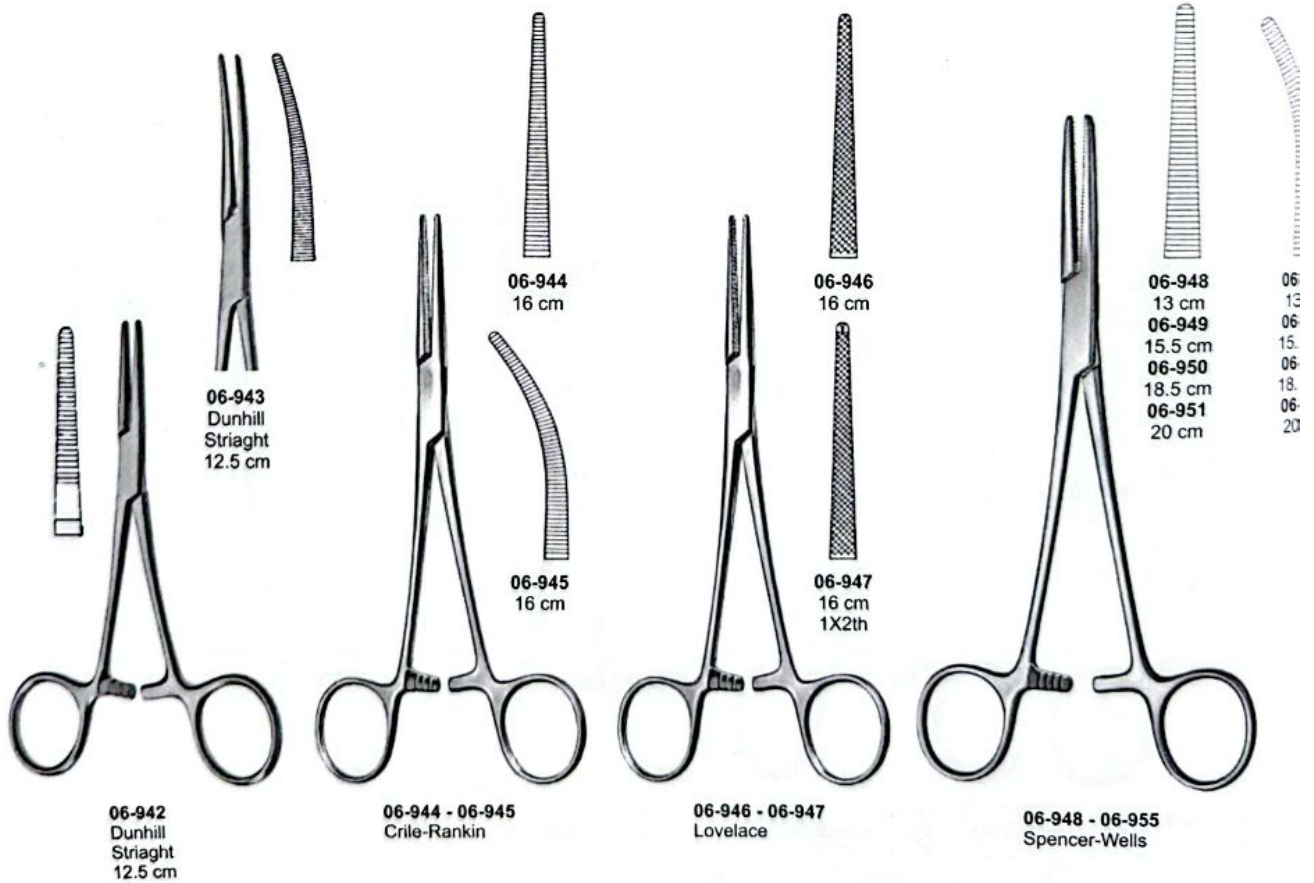

Haemostatic Forceps



06-956 - 06-957
Pean

06-958 - 06-963
Pean, Delicate pattern

06-964 - 06-981
Pean (Rochester)

06-982 - 06-987
Pean-Fino

- | | | | | | | | | |
|--|--|--|--|--|--|--|--|--|
| 06-956
14.5 cm
06-957
16 cm | 06-958
13.5 cm
06-959
14.5 cm
06-960
17 cm | 06-961
13 cm
06-962
14 cm
06-963
16.5 cm | 06-964
14.5 cm
06-965
16.5 cm
06-966
18.5 cm
06-967
20.5 cm | 06-968
22.5 cm
06-969
24.5 cm
06-970
26 cm
06-971
28.5 cm
06-972
30.5 cm | 06-973
14.5 cm
06-974
16.5 cm
06-975
18.5 cm
06-976
20.5 cm | 06-977
22.5 cm
06-978
24.5 cm
06-979
26 cm
06-980
28.5 cm
06-981
30.5 cm | 06-982
14 cm
06-983
16.5 cm
06-984
18.5 cm | 06-985
14 cm
06-986
16 cm
06-987
18 cm |
|--|--|--|--|--|--|--|--|--|

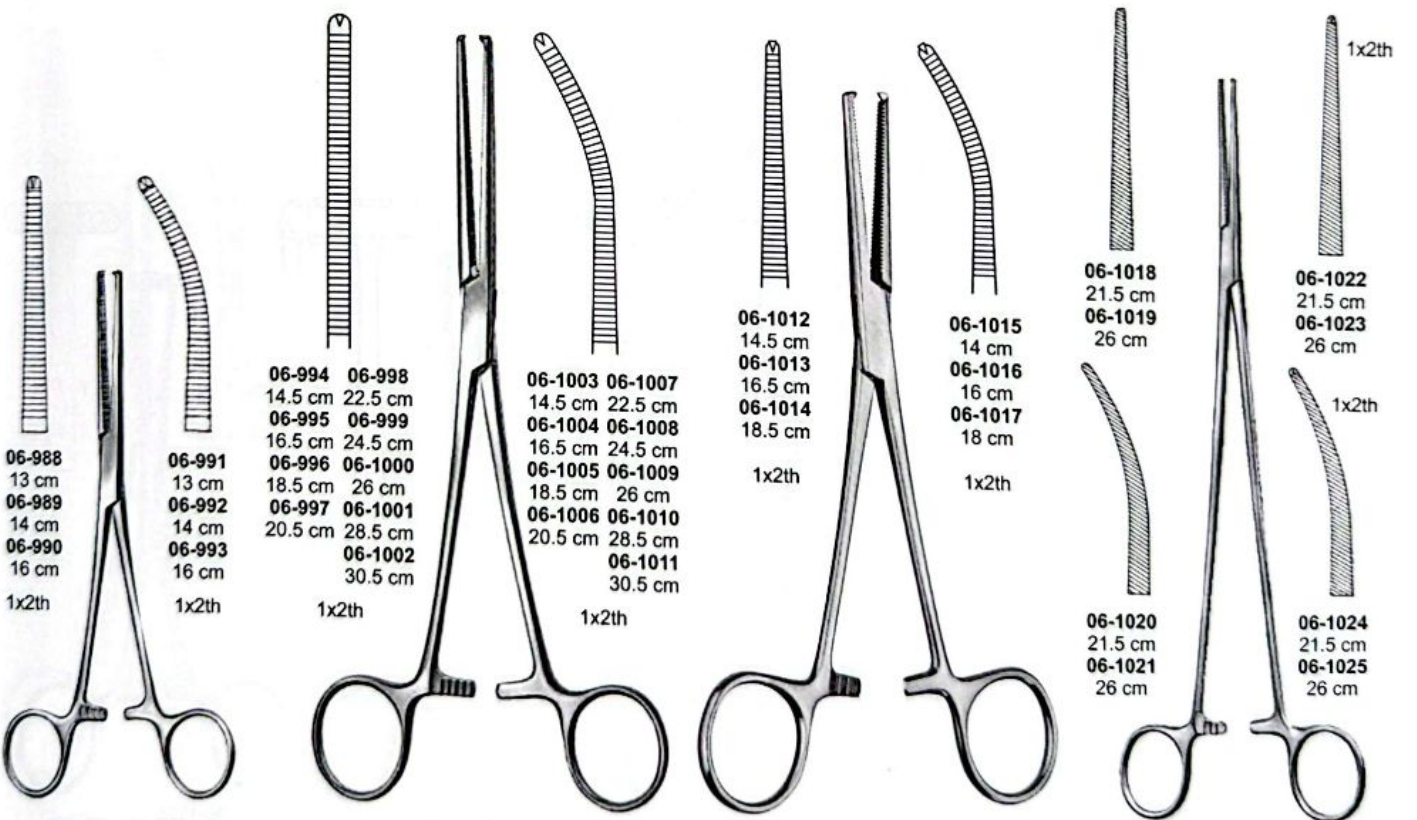

06-988 - 06-993
Kocher

06-994 - 06-1011
Kocher (Ochsner)

06-1012 - 06-1017
Kocher-Fino

06-1018 - 06-1025
Bengolea

- | | | | | | | | | | |
|---|---|--|--|--|--|--|--|---|---|
| 06-988
13 cm
06-989
14 cm
06-990
16 cm
1x2th | 06-991
13 cm
06-992
14 cm
06-993
16 cm
1x2th | 06-994
14.5 cm
06-995
16.5 cm
06-996
18.5 cm
06-997
20.5 cm
06-998
22.5 cm
06-999
24.5 cm
06-1000
26 cm
06-1001
28.5 cm
06-1002
30.5 cm
1x2th | 06-1003
14.5 cm
06-1004
16.5 cm
06-1005
18.5 cm
06-1006
20.5 cm
06-1007
22.5 cm
06-1008
24.5 cm
06-1009
26 cm
06-1010
28.5 cm
06-1011
30.5 cm
1x2th | 06-1012
14.5 cm
06-1013
16.5 cm
06-1014
18.5 cm
1x2th | 06-1015
14 cm
06-1016
16 cm
06-1017
18 cm
1x2th | 06-1018
21.5 cm
06-1019
26 cm | 06-1020
21.5 cm
06-1021
26 cm | 06-1022
21.5 cm
06-1023
26 cm
1x2th | 06-1024
21.5 cm
06-1025
26 cm
1x2th |
|---|---|--|--|--|--|--|--|---|---|



Haemostatic Forceps, Organ Grasping Forceps

Atrauma

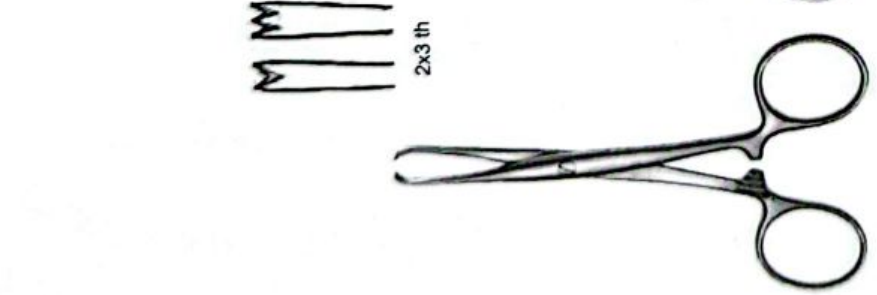

06-1026
Chaput
12.5 cm

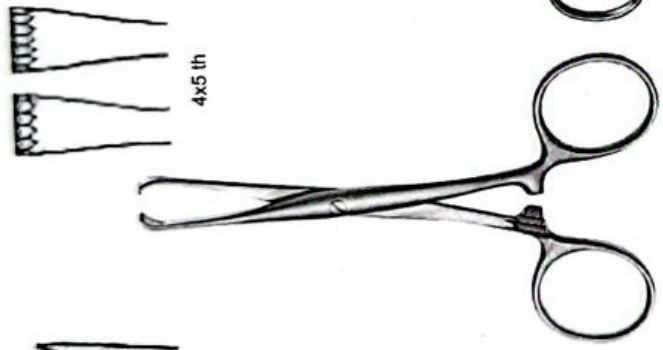

06-1027
Tuffier
12.5 cm



06-1028 - 06-1029



06-1028
25 cm

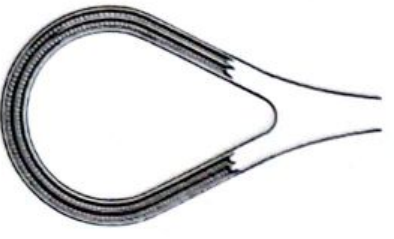

06-1029
26 cm

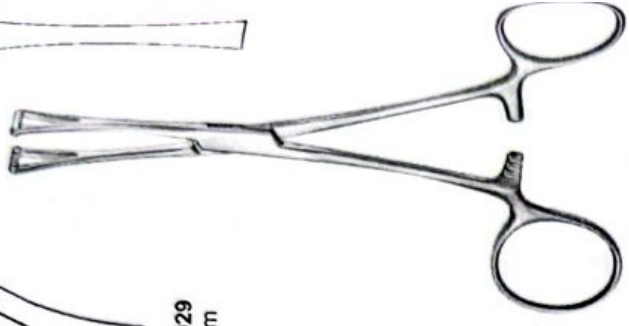

06-1030
Collin
14 cm

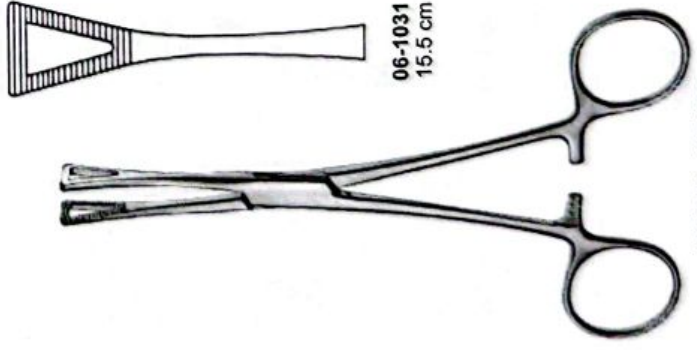

06-1031 - 06-1032
Pennington

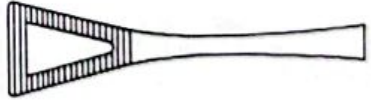

06-1031
15.5 cm

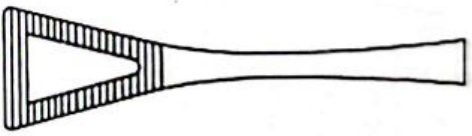

06-1032
21 cm

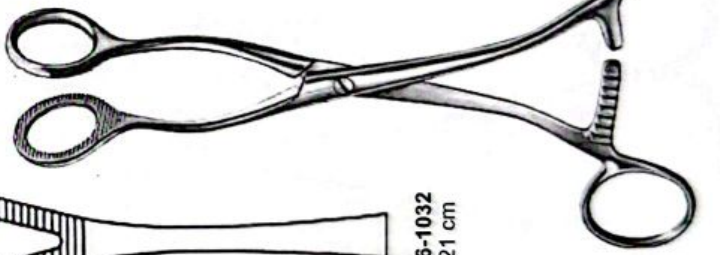

06-1033
Collin
Tumor Grasping Forceps
17 cm

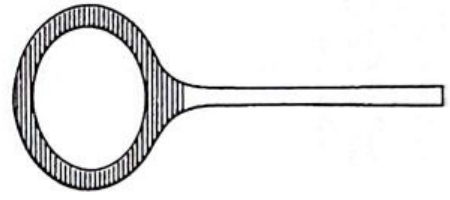

06-1034
Pratt
15 cm

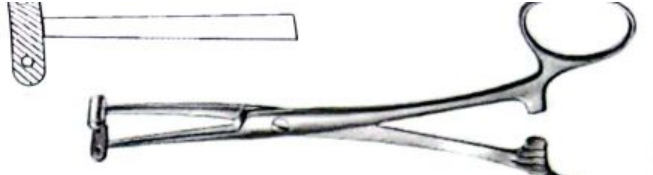

06-1035
Martel
Face-lift Forceps
13.5 cm

Haemostatic Forceps, Dissecting and Ligature Forceps

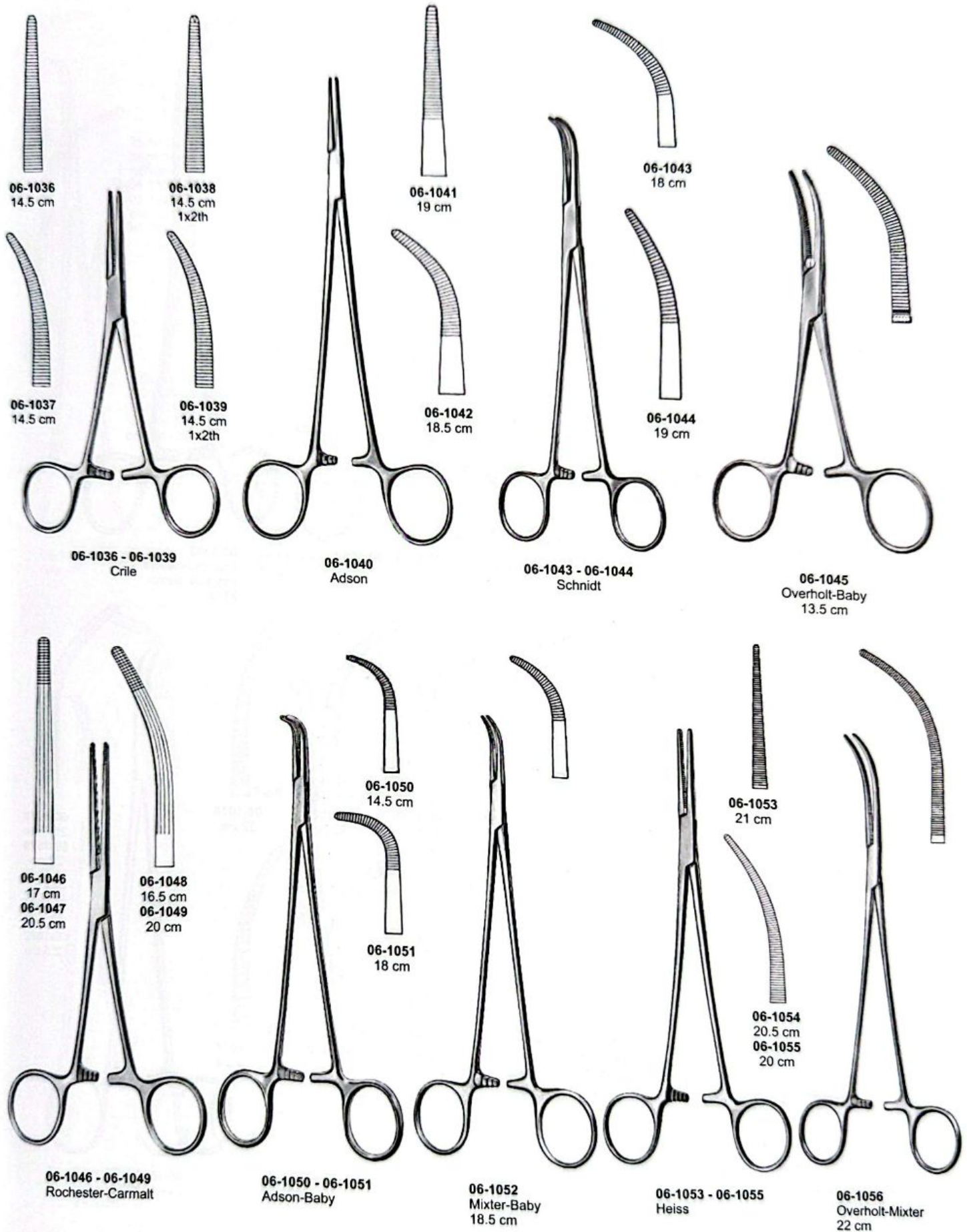

Dissecting and Ligature Forceps

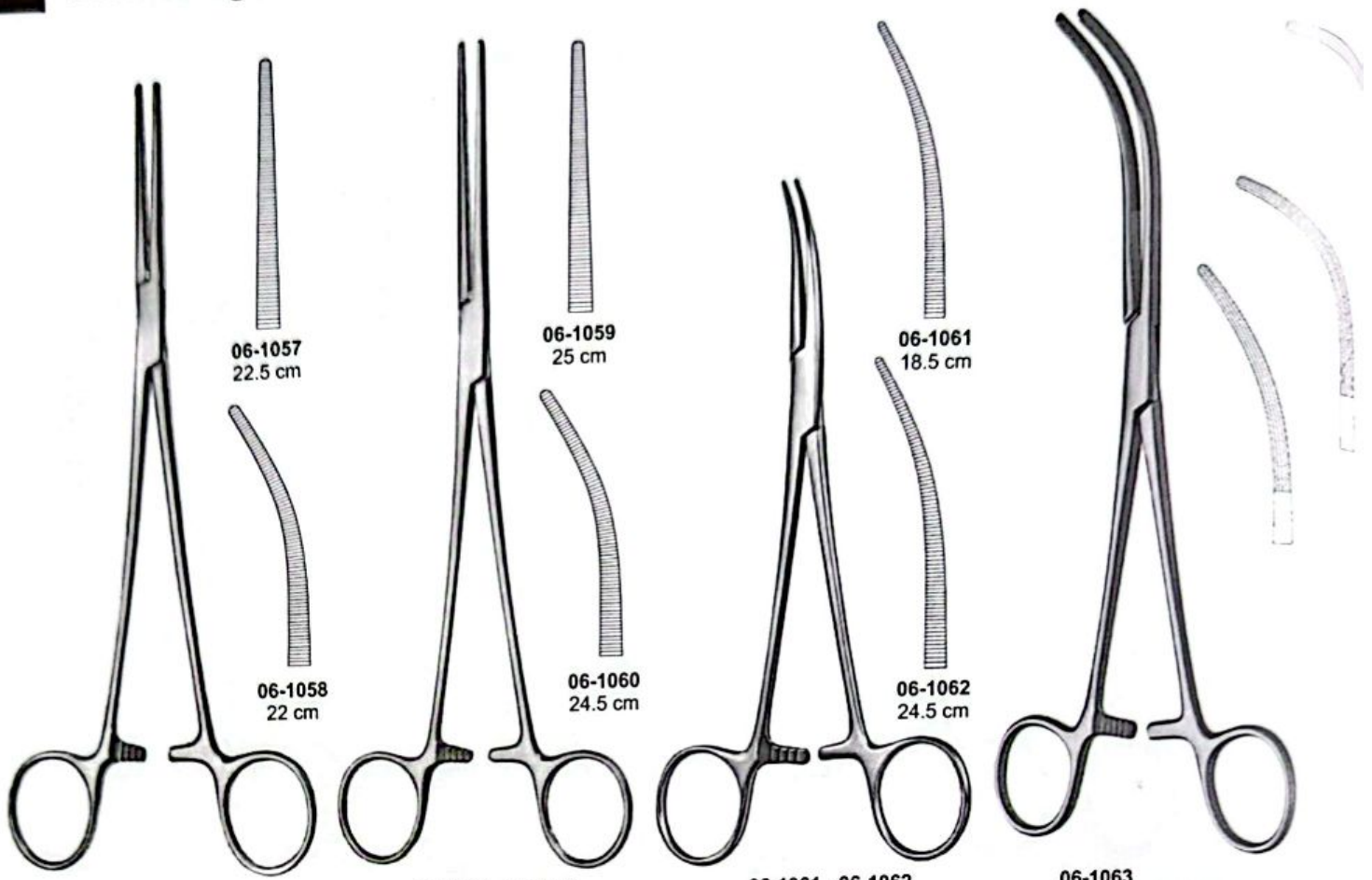

06-1057 - 06-1058
Roberts

06-1059 - 06-1060
Sarot

06-1061 - 06-1062
Crafoord

06-1063
Crafoord-Sellors
Vascular clamp
24 cm

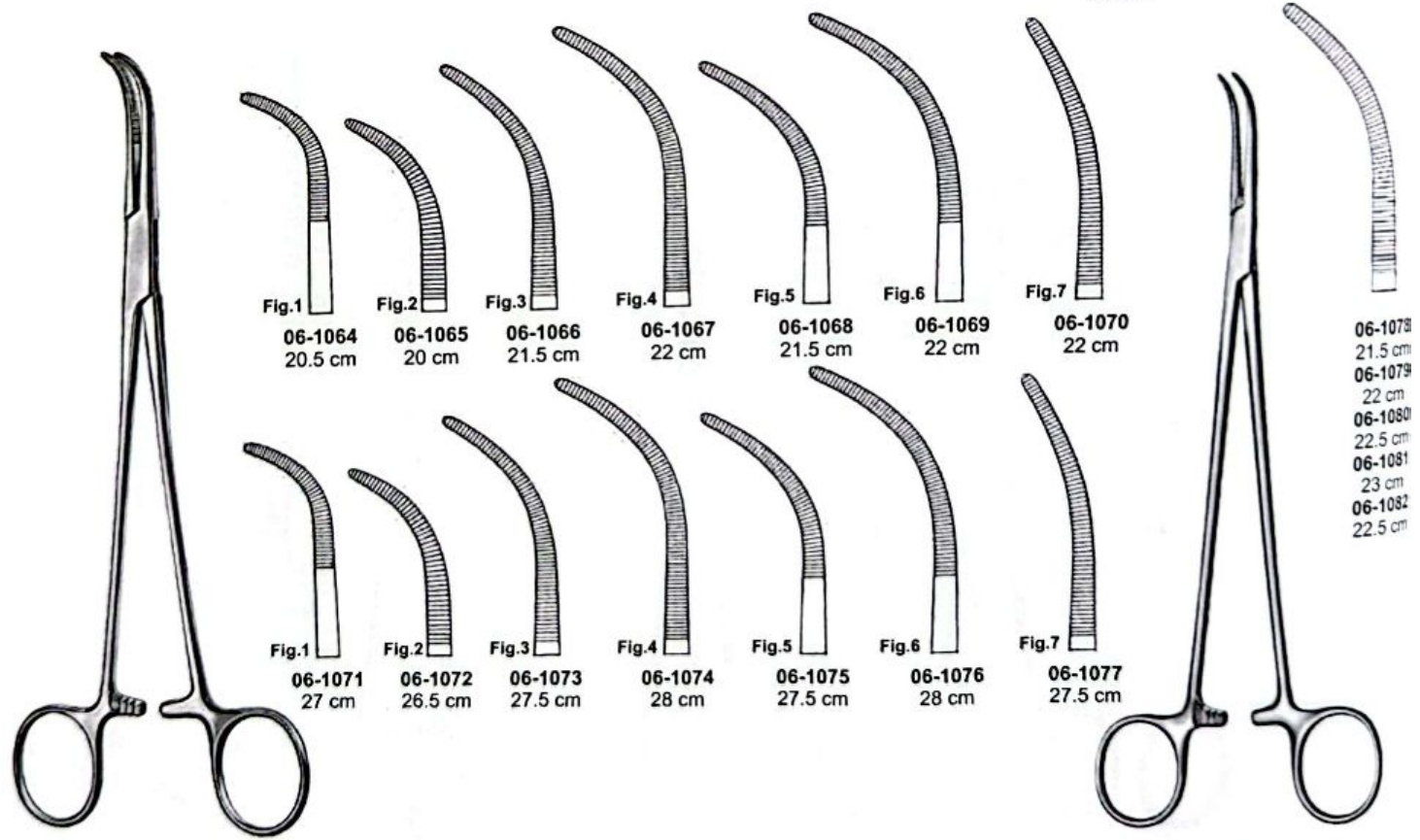

06-1064-06-1077
Overholt-Geissendörfer

06-1078 - 06-1082
Overholt-Fino



Artery Forceps

Bile Duct Clamps, Dissecting and Ligature Forceps

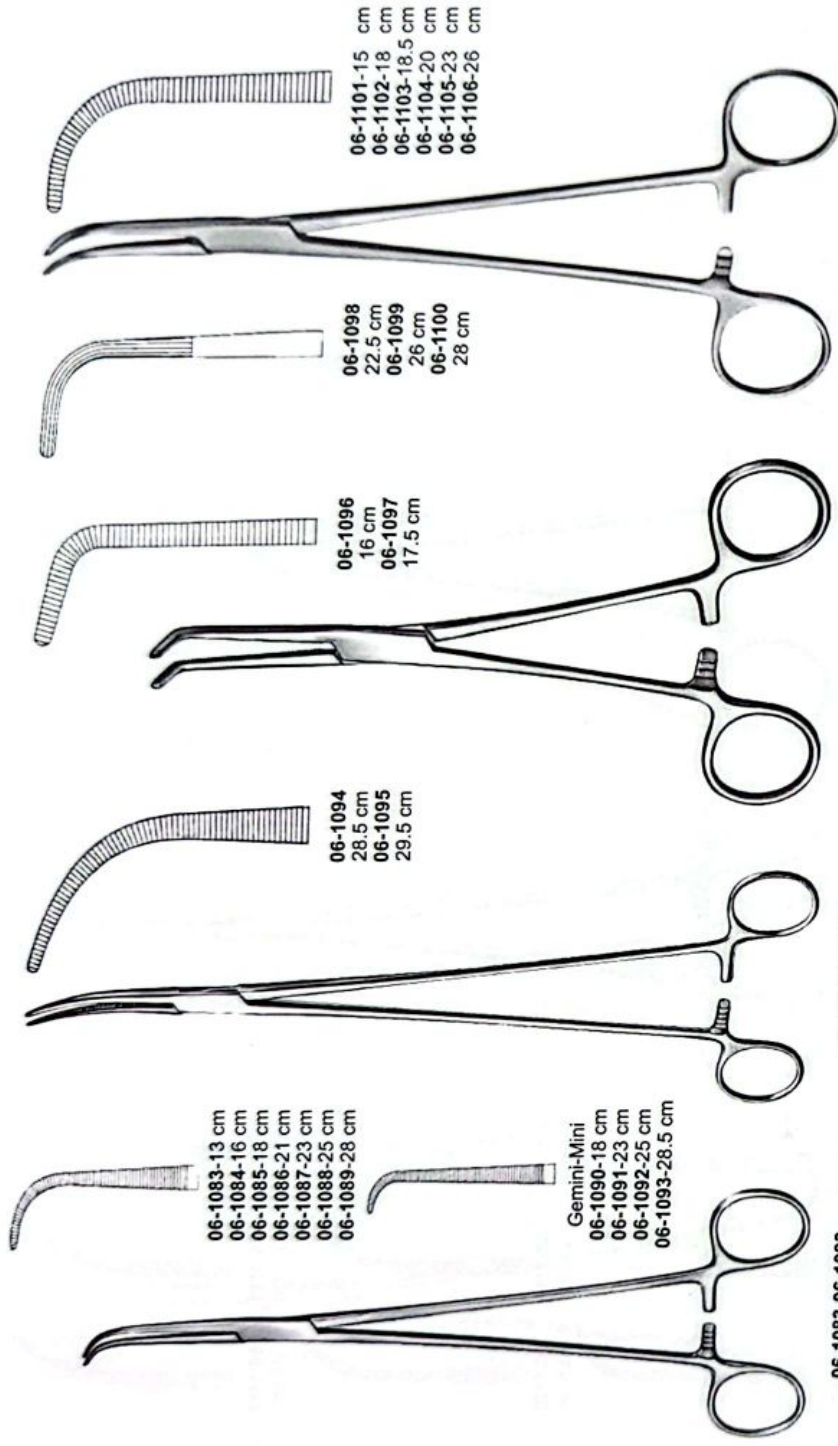

06-1083-13 cm
06-1084-16 cm
06-1085-18 cm
06-1086-21 cm
06-1087-23 cm
06-1088-25 cm
06-1089-28 cm

Gemini-Mini
06-1090-18 cm
06-1091-23 cm
06-1092-25 cm
06-1093-28.5 cm

06-1094
28.5 cm
06-1095
29.5 cm

06-1096
16 cm
06-1097
17.5 cm

06-1098
22.5 cm
06-1099
26 cm
06-1100
28 cm

06-1101-15 cm
06-1102-18 cm
06-1103-18.5 cm
06-1104-20 cm
06-1105-23 cm
06-1106-26 cm

06-1083-06-1093
Gemini

06-1094-06-1095
Zenker

06-1096-06-1097
Mixer

06-1098-06-1106
Mixer O'Shaughnessy

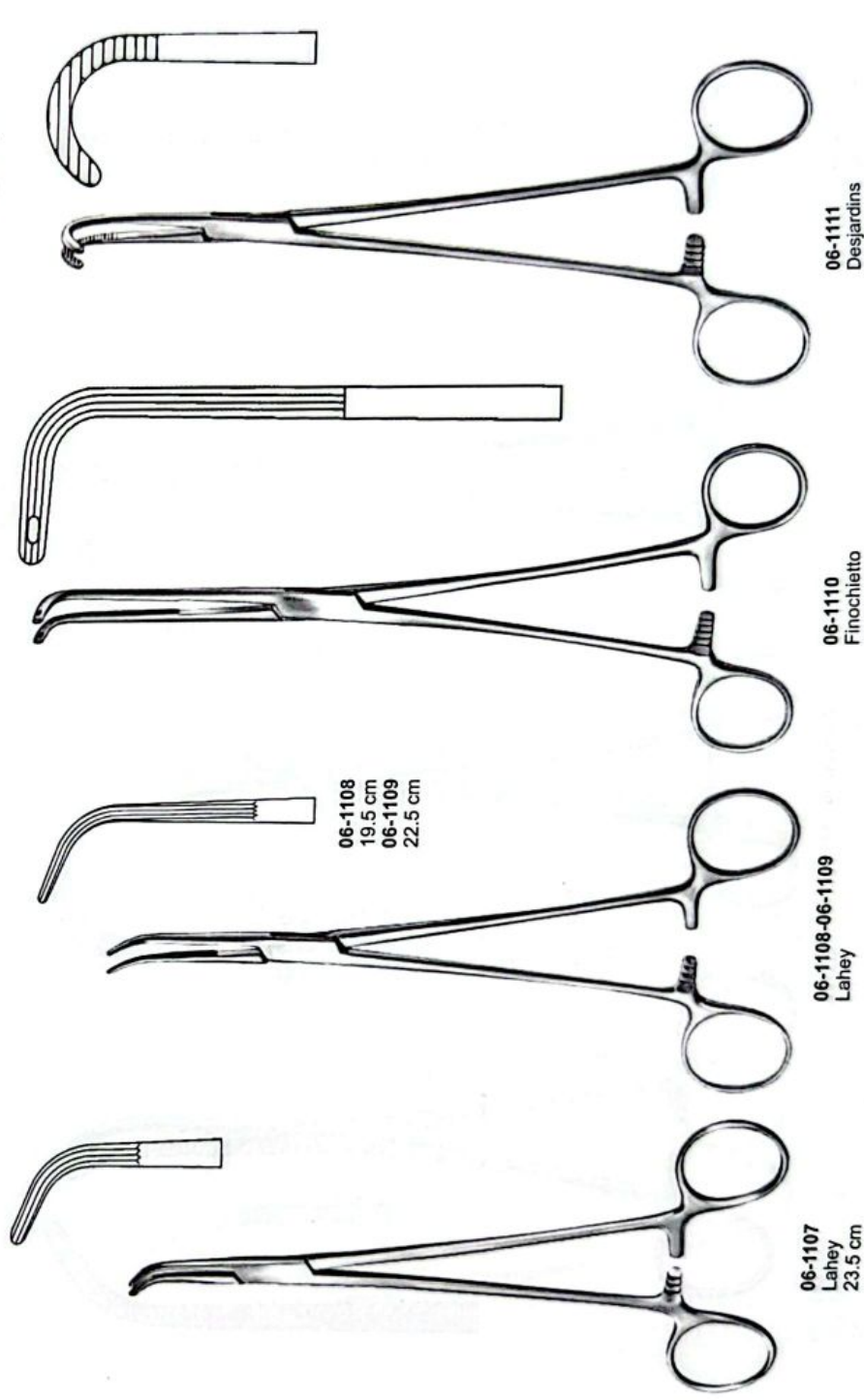

06-1108
19.5 cm
06-1109
22.5 cm

06-1107
Lahey
23.5 cm

06-1108-06-1109
Lahey

06-1110
Finochietto
24.5 cm

06-1111
Desjardins
21 cm



Artery Forceps

Dissecting and Ligature Forceps

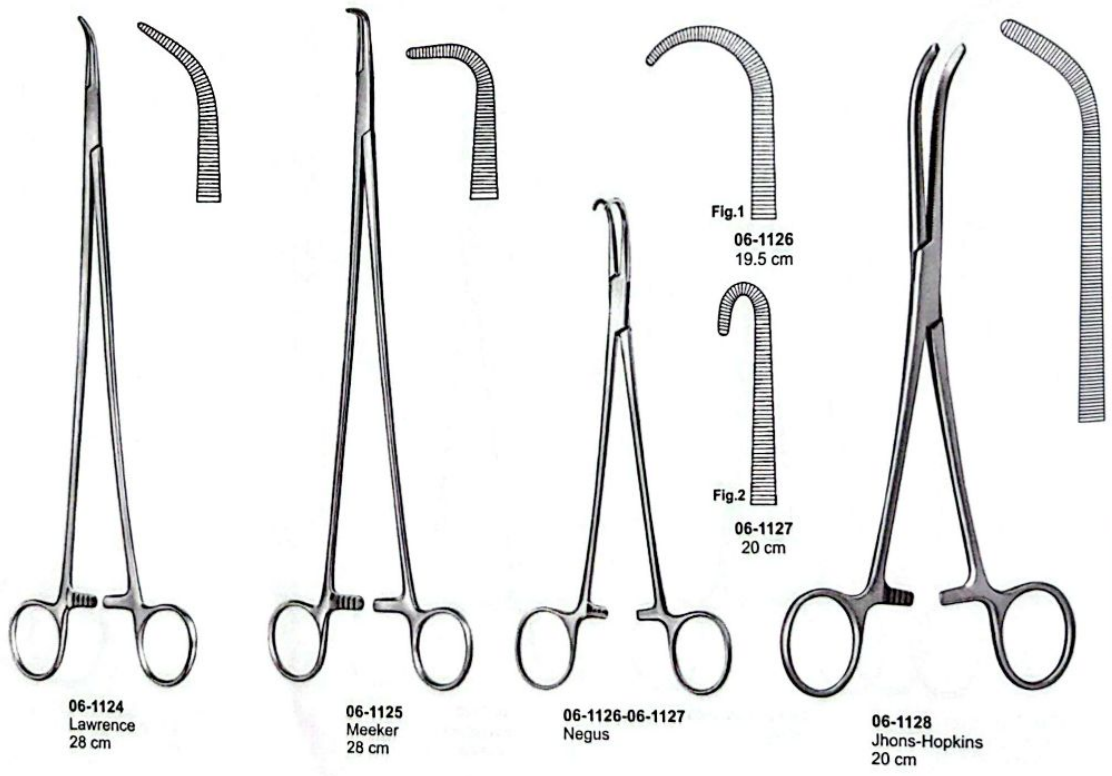
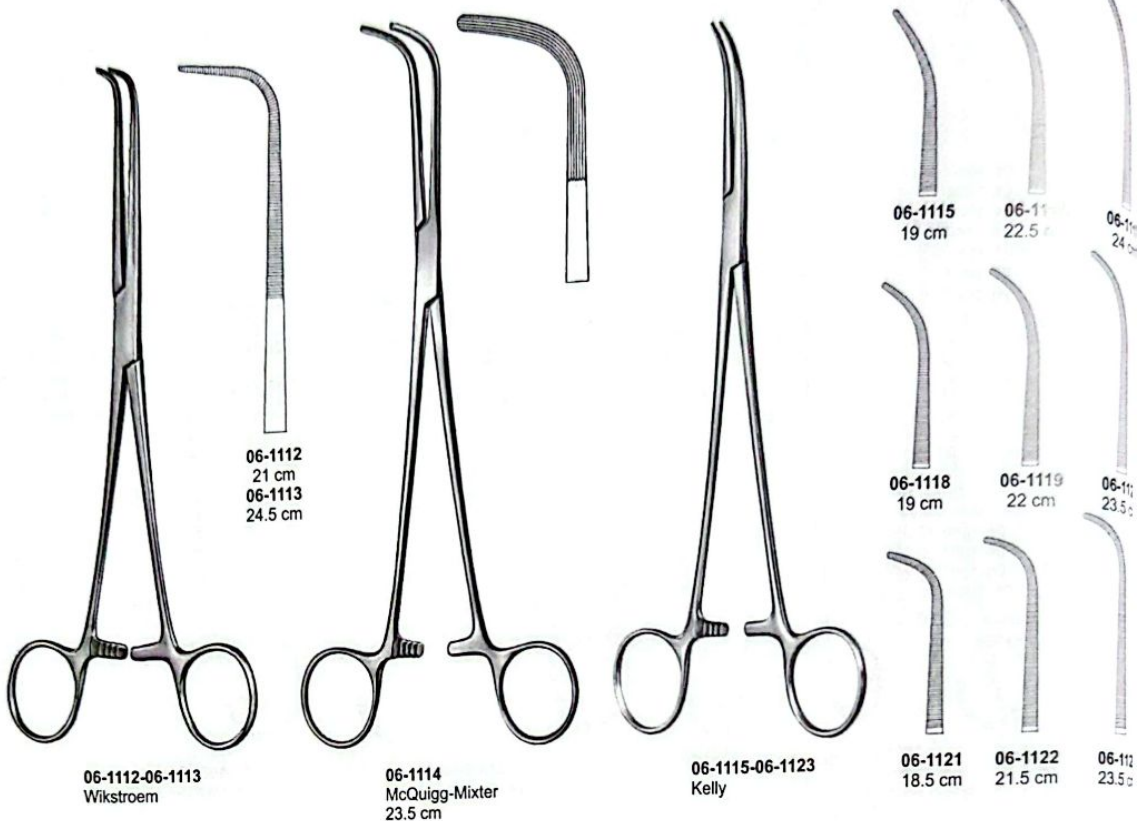

Hysterectomy & Peritoneum Forceps

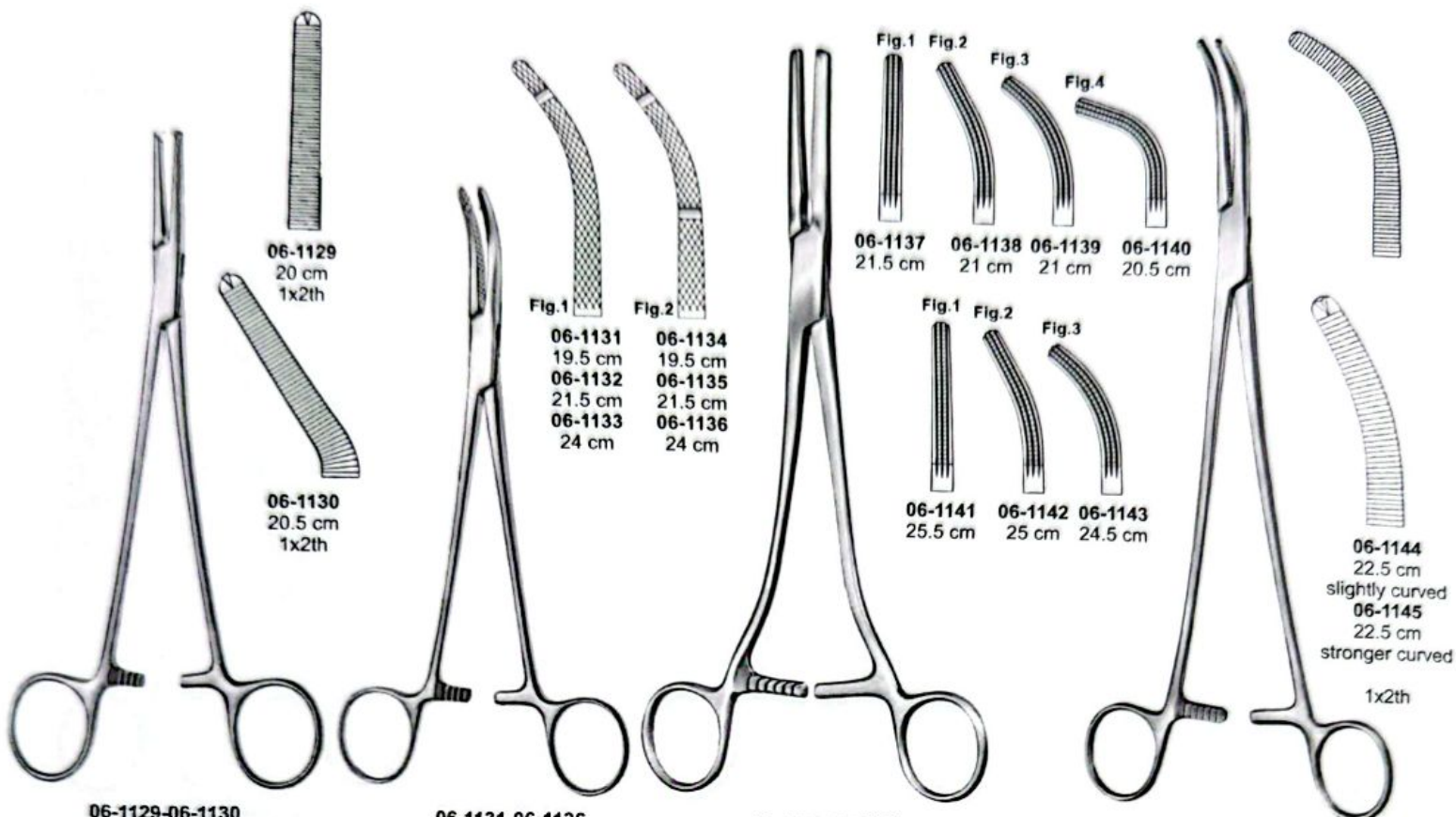

06-1129-06-1130
Phaneuf

06-1131-06-1136
Heaney

06-1137-06-1143
Rogers

06-1144-06-1145
Wertheim

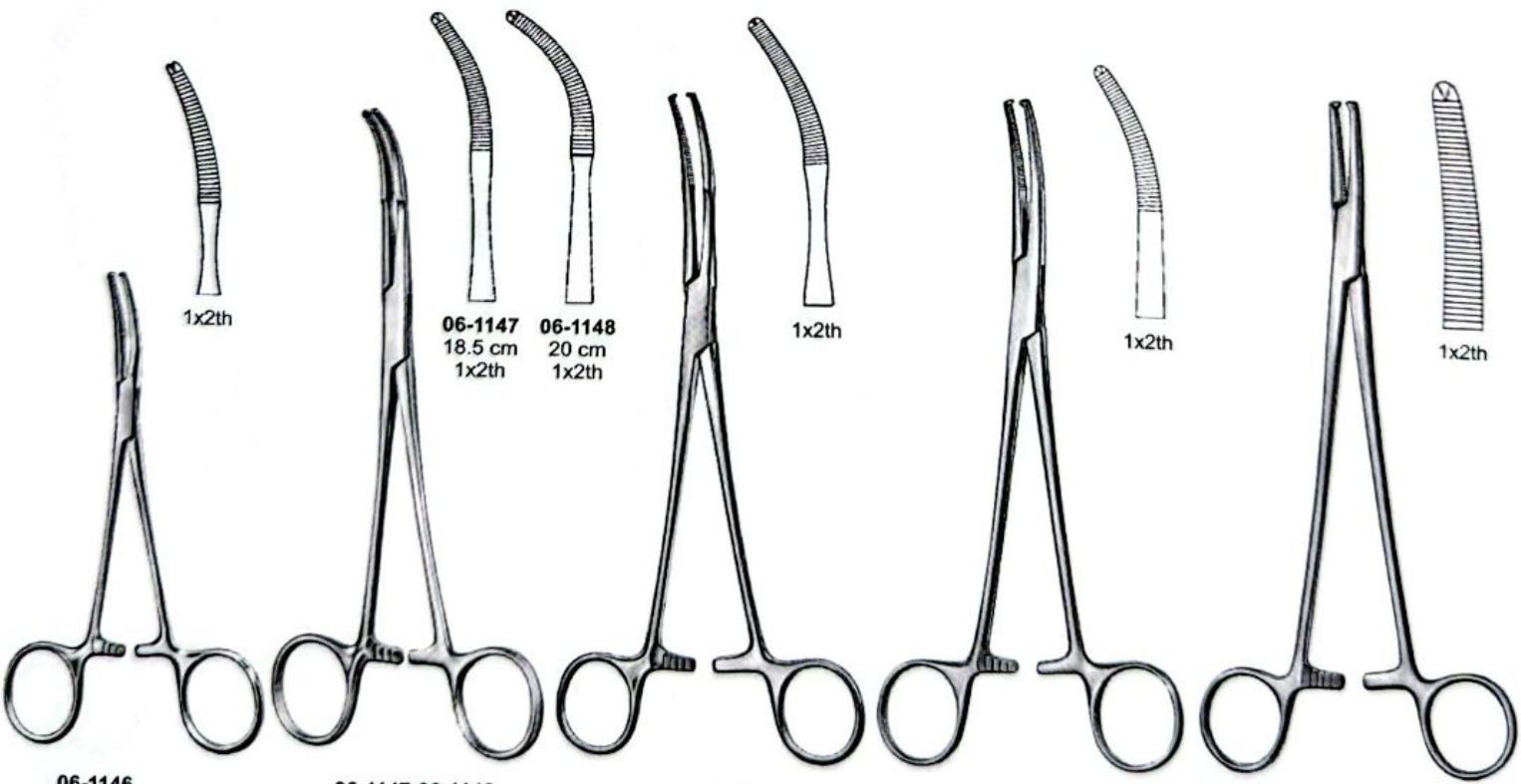

06-1146
Mikulicz-Baby
14.5 cm

06-1147-06-1148
Mikulicz

06-1149
Mikulicz
20 cm

06-1150
Mikulicz
20.5 cm

06-1151
Faure
21 cm



Tangential Forceps, Vaginal & Kidney Pedicle Clamps



06-1152-06-1153
Uro-Tangential

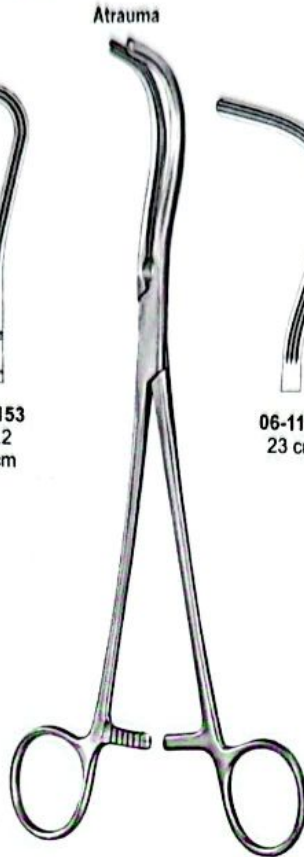

06-1154-06-1155
Guyon

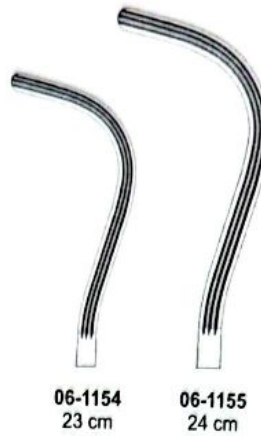

06-1156
Wertheim-Cullen
21 cm

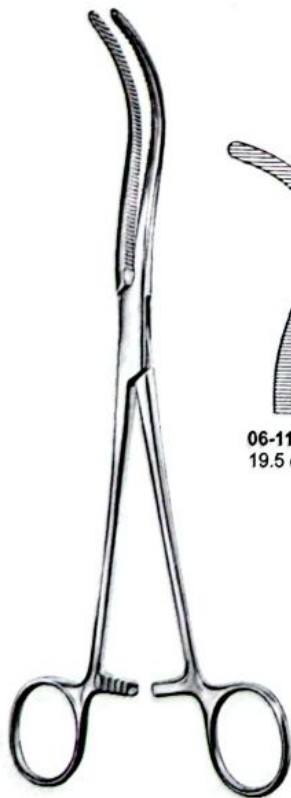

06-1157-06-1159
Guyon

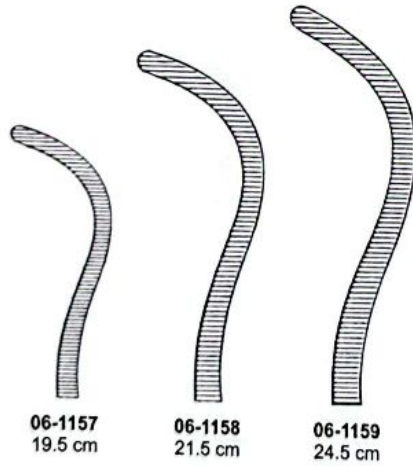

06-1160
Guyon
24 cm



06-1161
Mayo-guyon
23 cm



Towel Clamps



06-1162
Schadel Sharp
9 cm



06-1163
ENGL. MODELL
9 cm



JONES
06-1164-5.5 cm
06-1165-8.5 cm
Sharp



06-1166
JONES Sharp
With Clip for Tubing
or Cable 8.5 cm



06-1167
DOYEN
11 cm

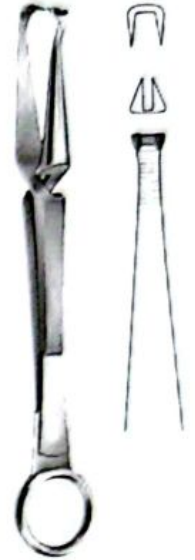

06-1168
DOYEN
18 cm

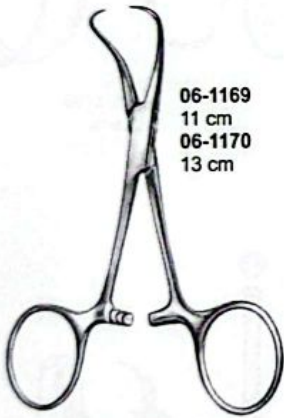

06-1169
11 cm
06-1170
13 cm

06-1169-06-1170
Backhaus
Delicate pattern
sharp



06-1171
Backhaus with Clip
for Tubing or Cable
11 cm

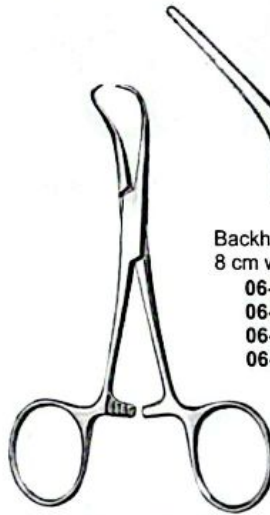

Backhaus Towel
8 cm with open jaws
06-1172-8 cm
06-1173-11 cm
06-1174-13 cm
06-1175-15 cm

06-1172-06-1175
Backhaus
sharp

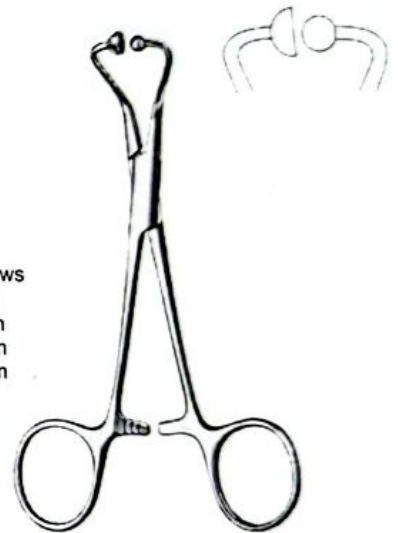

Ball & Socket
06-1176-11.5 cm
06-1177-14 cm

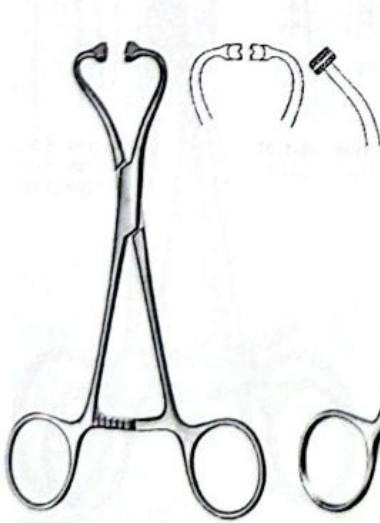

06-1178
Peers-Bertrammodif.
wide jaw for tube fixation
15 cm

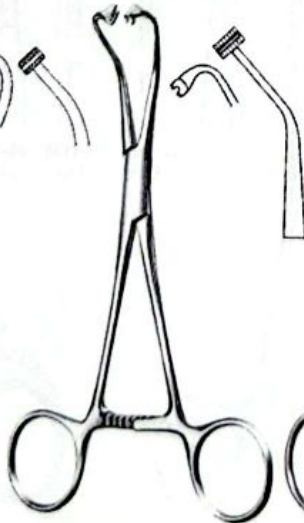

06-1179
Peers-Bertram
14.5

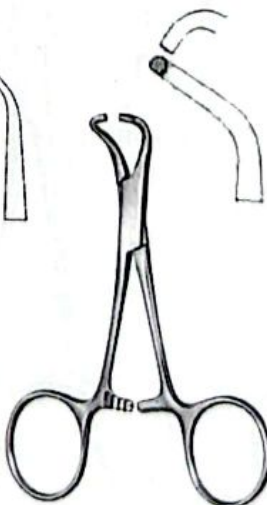

Tohoku (Blunt)
06-1180-10.5 cm
06-1181-13.5 cm



06-1182
ROBIN-13.5 cm
with holder for
cable up to 5 mm



06-1183
ROBIN-13.5 cm
with holder for cable
up to 13 mm tubing



Towel Clamps & Tubing Clamps

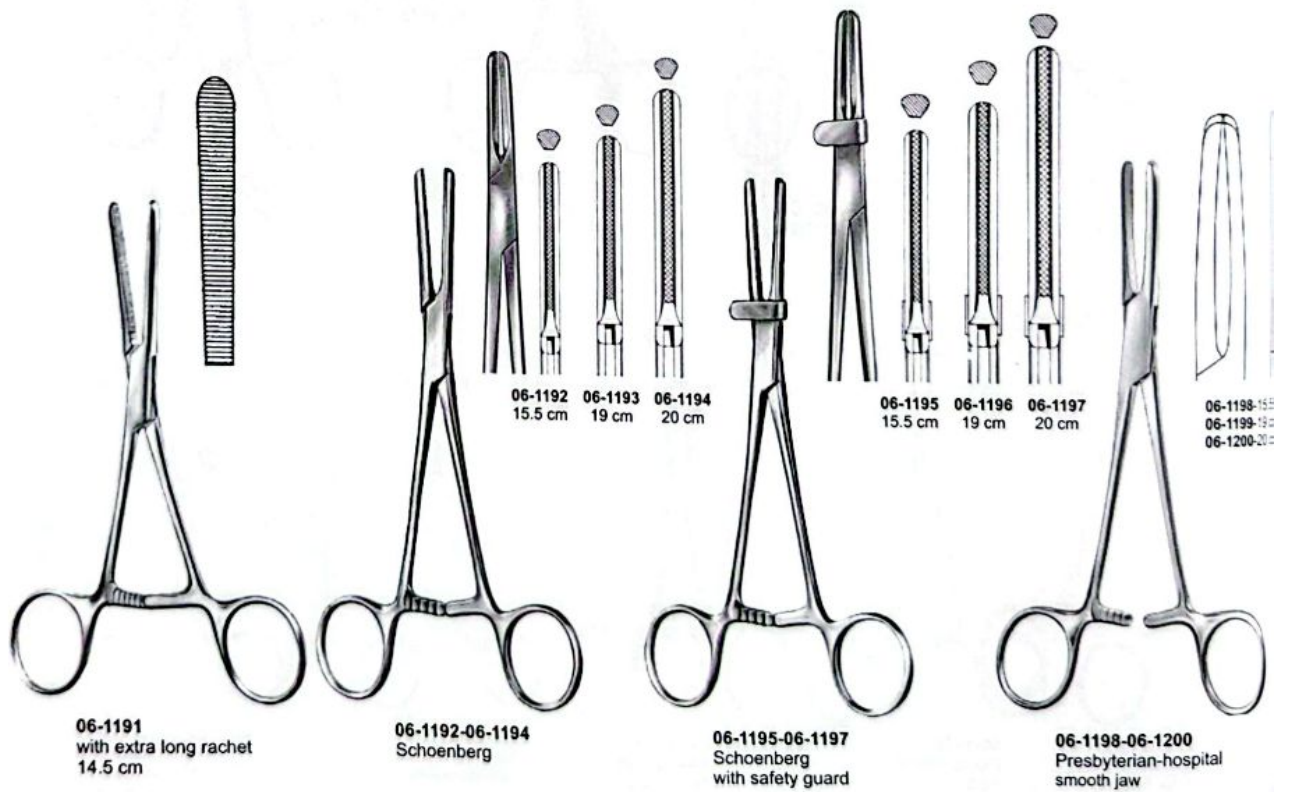
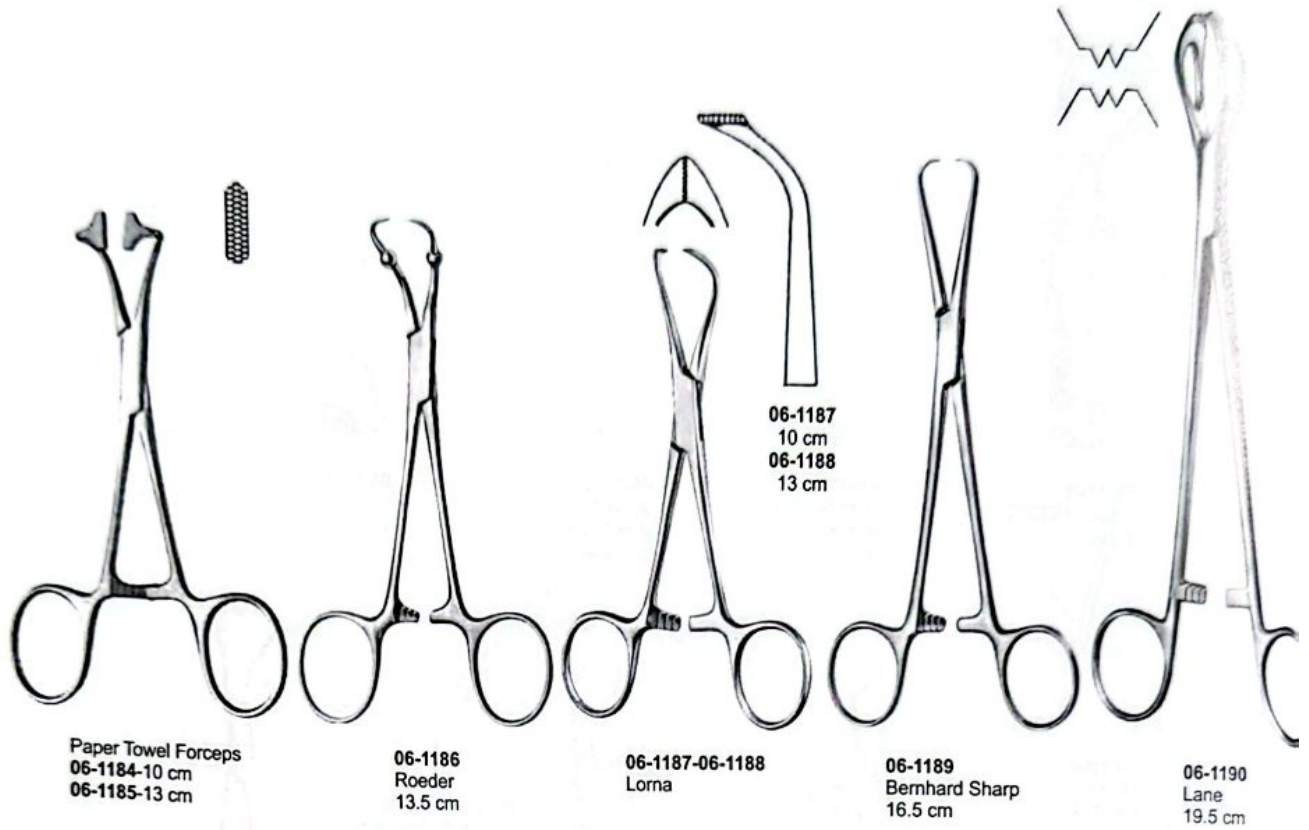

Reposition Forceps

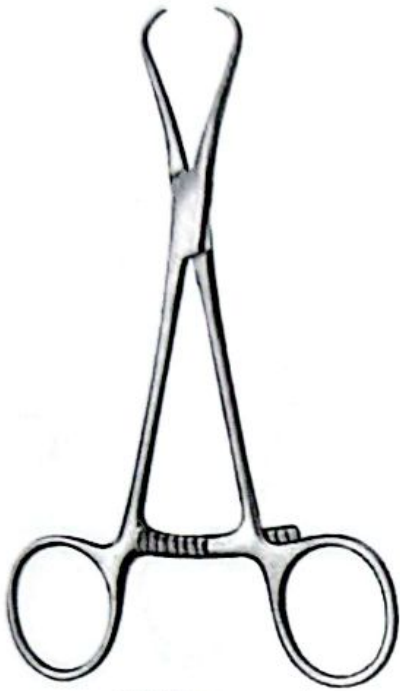

Steinhäuser
06-1201
13,5 cm



Lewin
06-1202
18 cm



Haase
06-1203
16,5 cm

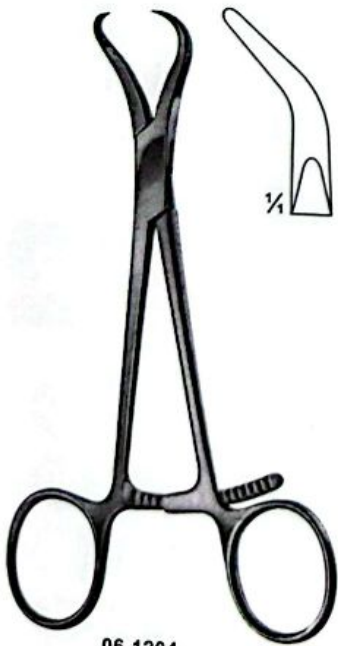

06-1204
Reposition forceps,
for small fragments
135 mm

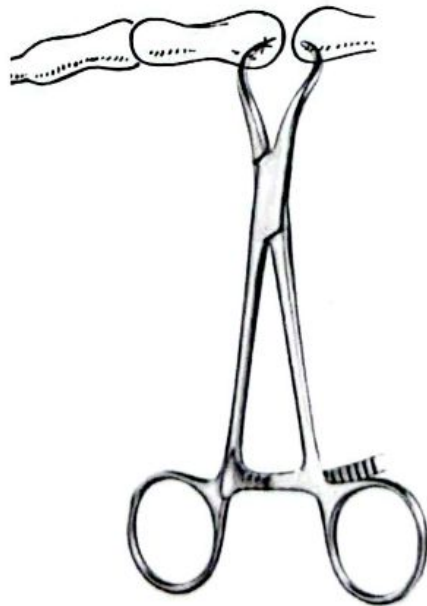

06-1205
15 cm
lange Sperre
long ratchet

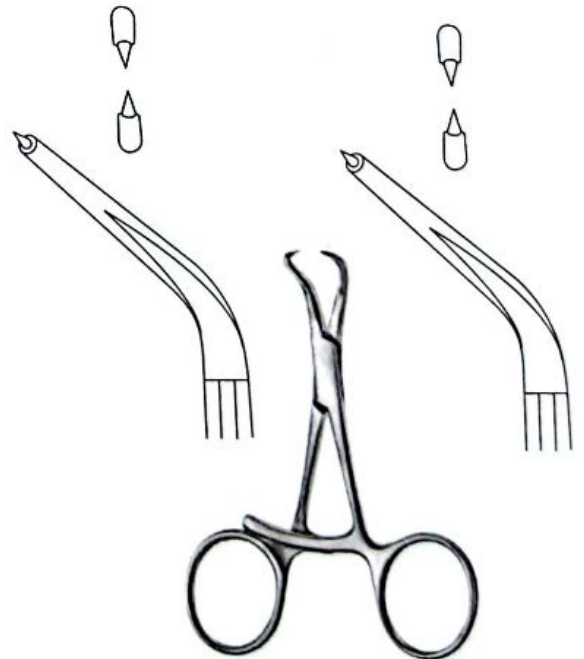

06-1206
9,5 cm
lange Sperre
long ratchet
cremallera



Reposition Forceps



06-1207
21 cm

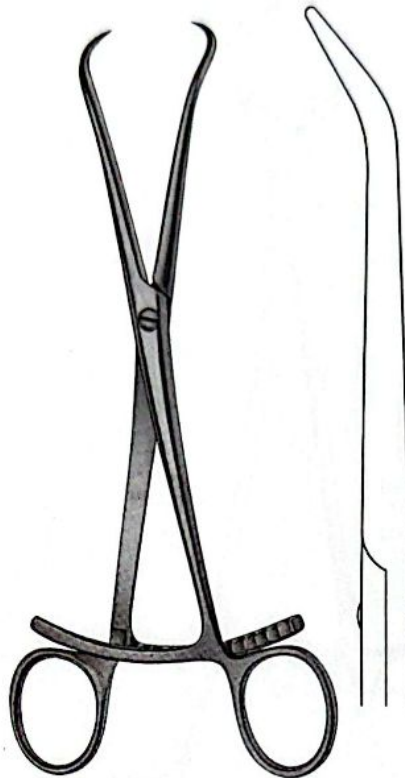

06-1208
Reposition forceps
205 mm



06-1209
Meyer
20 cm

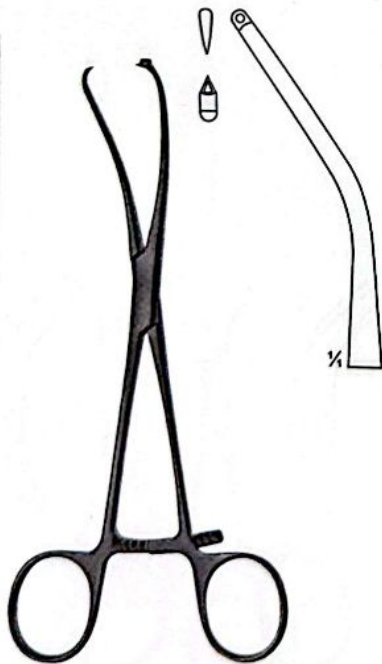

06-1210
MEYER
Reposition forceps
for fingers, with drill
guide for KIRSCHNER
wires up to diam. 1.0 mm
170 mm

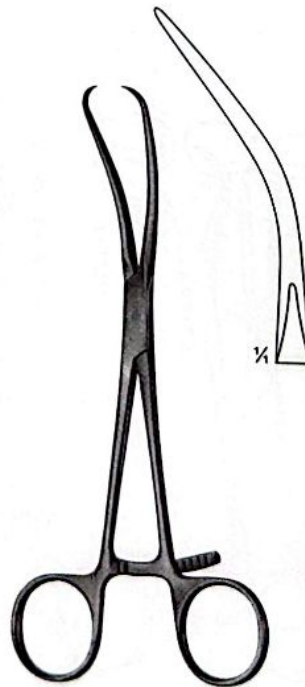

06-1211
REILL
Reposition forceps,
170 mm



06-1212
Reposition forceps,
14 cm



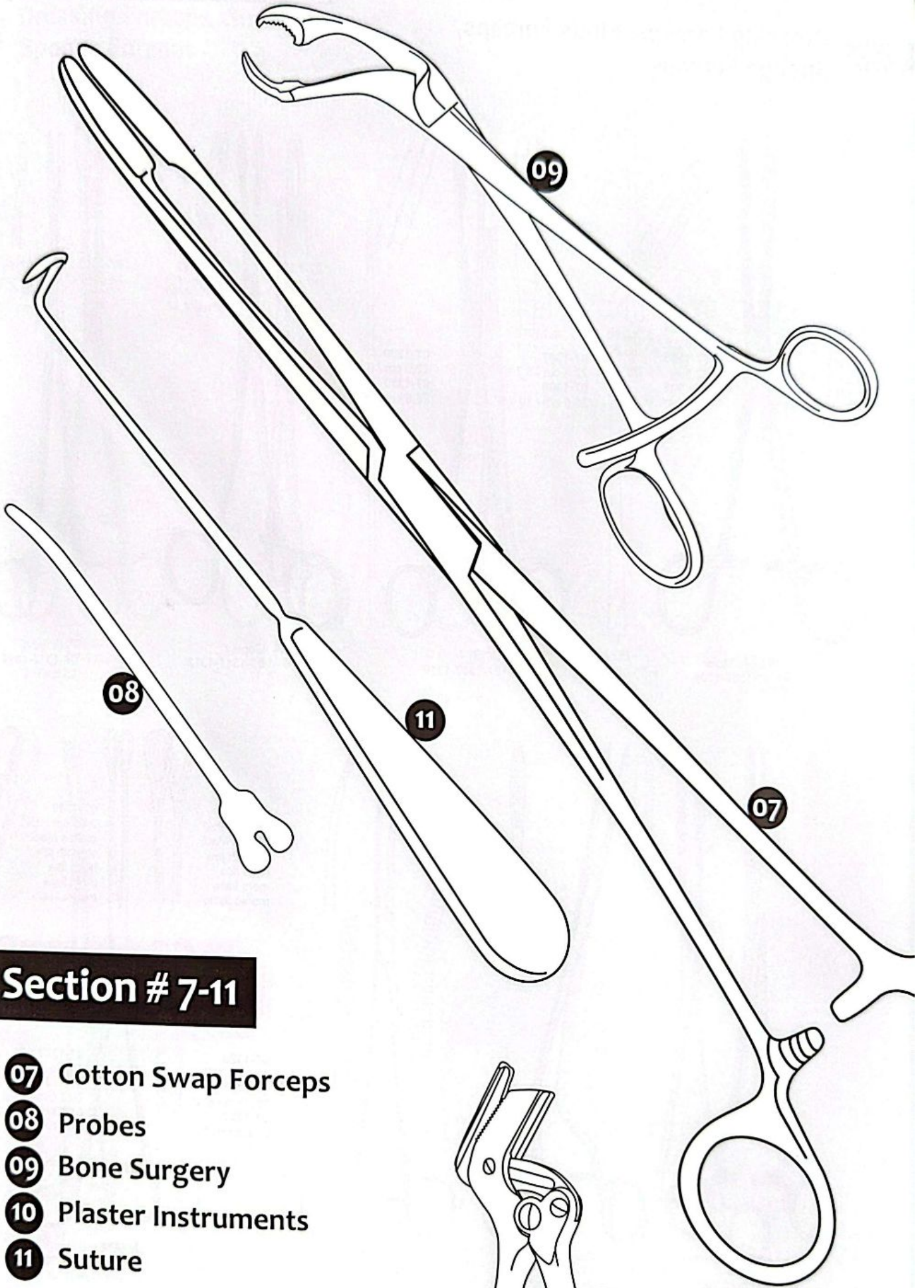

Section # 7-11

- 07** Cotton Swap Forceps
- 08** Probes
- 09** Bone Surgery
- 10** Plaster Instruments
- 11** Suture

Dressing Forceps, Sinus Forceps,
Sponge Forceps



07-1301
20,5 cm / 8 1/8"
07-1302
22,5 cm / 8 7/8"
07-1303
26,5 cm / 10 3/8"

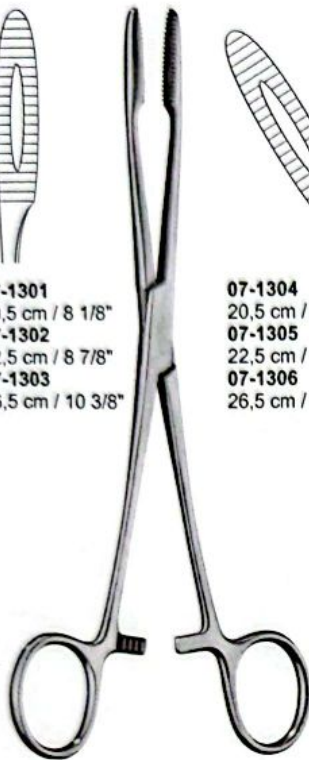

Gross-Maier
07-1301-1306

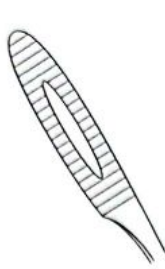

07-1304
20,5 cm / 8 1/8"
07-1305
22,5 cm / 8 7/8"
07-1306
26,5 cm / 10 3/8"



07-1307
22,5 cm / 8 7/8"
07-1308
26,6 cm / 10 4/8"

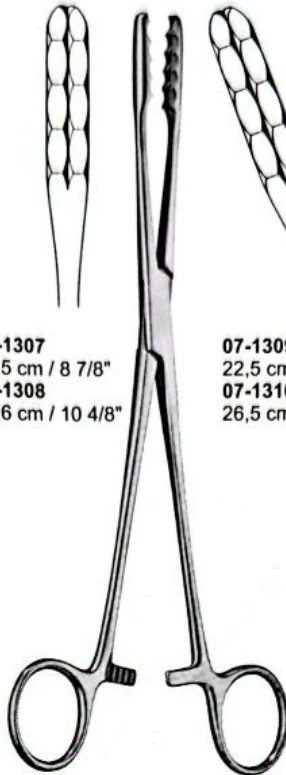

Ulrich
07-1307-1310

07-1309
22,5 cm / 8 7/8"
07-1310
26,5 cm / 10 7/8"

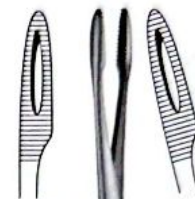

07-1311
20 cm/7"

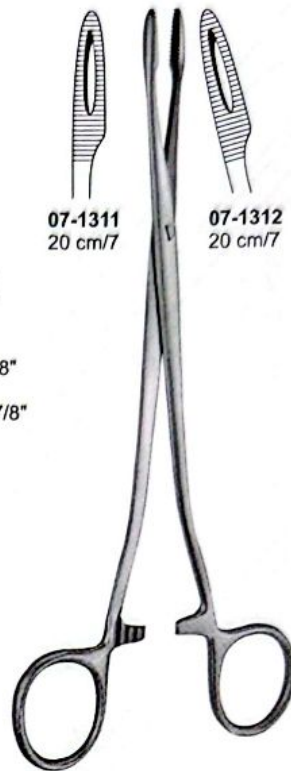

Duplay
07-1311-1312



07-1312
20 cm/7"



07-1313
25 cm/9 1/2"



Pelkmann
07-1313-1314
25 cm/9 1/2"



Collin
07-1315
25 cm / 9 7/8"



Cheron
07-1316
25 cm / 9 1/2"

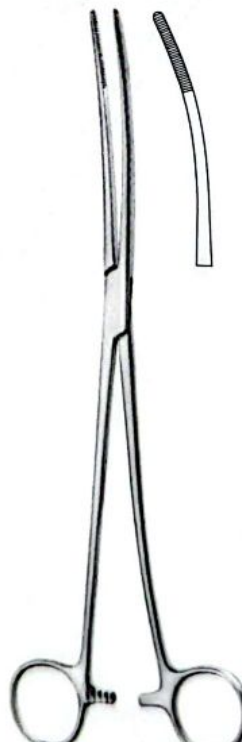

Bozemann
07-1317
26 cm / 10 2/8"
S-Form / S-shape
curve in forma S

07-1318
25 cm / 9 1/2"
glattes Maul
smooth jaw
boca lisa
mors lisse
morso liscio



07-1319
24,5 cm / 9 1/2"
glattes Maul
smooth jaw
boca lisa
mors lisse
morso liscio



07-1320
18 cm / 7 1/4"
07-1321
20,5 cm / 8 1/4"
07-1322
25 cm / 9 1/4"



07-1323
18 cm / 7 1/4"
07-1324
20,5 cm / 8 1/4"
07-1325
24,5 cm / 9 1/4"

Forster
07-1318-1325



Dressing Forceps, Sinus Forceps,
Sponge Forceps



07-1326
18.5 cm / 7 1/4"



07-1327
24.5 cm / 9 3/4"

Rampley
07-1326-1327

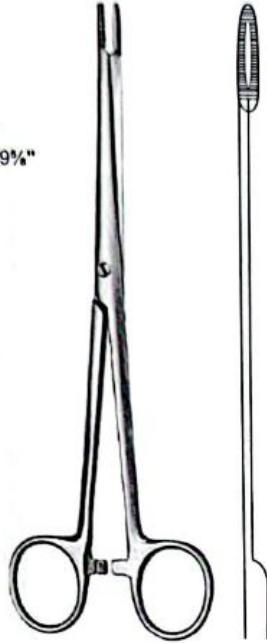

Martin
07-1328
17.5 cm / 6 7/8"



07-1329
13 cm / 5 1/4"

Lister
07-1329-1331



07-1330
16 cm / 6 2/8"

07-1331
18.5 cm / 7 2/8"

Emmet
07-1332
21 cm / 8 1/4"



Tunneling Forceps
07-1333
39.5 cm / 15 4/8"

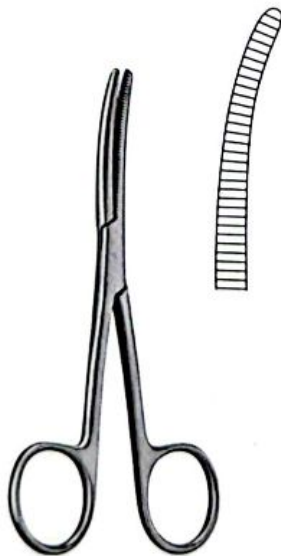

Bryant
07-1334
13.5 cm / 5"



Fletcher (javers)
07-1335
24 cm / 9 1/2"



Probes, Seeker and Directors,
Cotton Applicators



Silver
08-1401



Fish
08-1402
14.5cm
18.0cm



Stacke
08-1403
Ø 1 mm
10 cm / 3 7/8"



Doyen
08-1404
14.0cm



Nelaton
08-1405
16.0cm



Kronecker
08-1406
13.0 cm



Johns-hopkins
08-1407
13.0 cm



ROSER
08-1408
12.5 cm



SYME
08-1409
17.0 cm



08-1410
17.0 cm



Farrel
08-1411 12.0cm
08-1412 14.0cm
08-1413 16.0cm
08-1414 18.0cm
08-1415 23.0cm



Jobson-horne
08-1416
12.5cm
08-1417
18.0cm



Myrtle Leaf Probe
08-1418-1422

- 08-1418
13 cm / 5 1/8" Ø 2,0 mm
- 08-1419
14,5 cm / 5 7/8" Ø 2,0 mm
- 08-1420
16 cm / 6 2/8" Ø 2,0 mm
- 08-1421
18 cm / 7 1/8" Ø 2,0 mm
- 08-1422
20 cm / 7 7/8" Ø 2,0 mm



Lockhart-Mummery
08-1423-1426



08-1423
16,5 cm / 6 1/8"

08-1424
16,5 cm / 6 1/8"

08-1425
16,5 cm / 6 1/8"

08-1426
16,5 cm / 6 1/8"



Probes, Seeker and Directors, Cotton Applicators

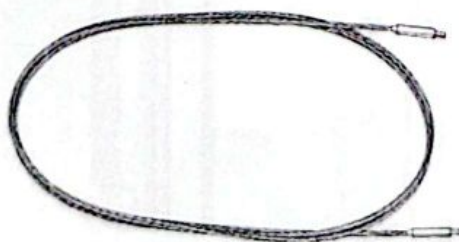
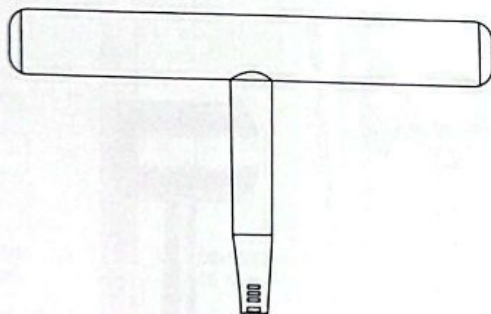
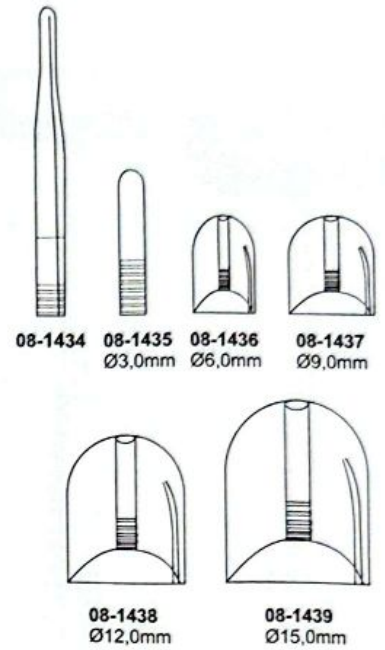
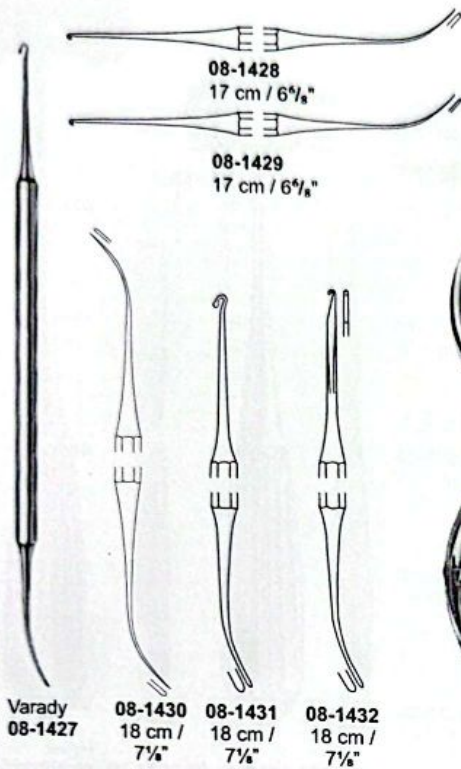

08-1442
12 cm / 4 7/8" Ø 0,9 mm
08-1443
14 cm / 5 1/2" Ø 0,9 mm
08-1444
16 cm / 6 1/4" Ø 1,1 mm

Farrell
08-1442-1444



08-1445
14 cm / 5 1/2" Ø 1,2 mm
08-1446
15 cm / 5 7/8" Ø 1,2 mm
08-1447
16 cm / 6 1/4" Ø 1,2 mm
08-1448
18 cm / 7 1/8" Ø 1,2 mm

Farrell
08-1445-1448

Mallets

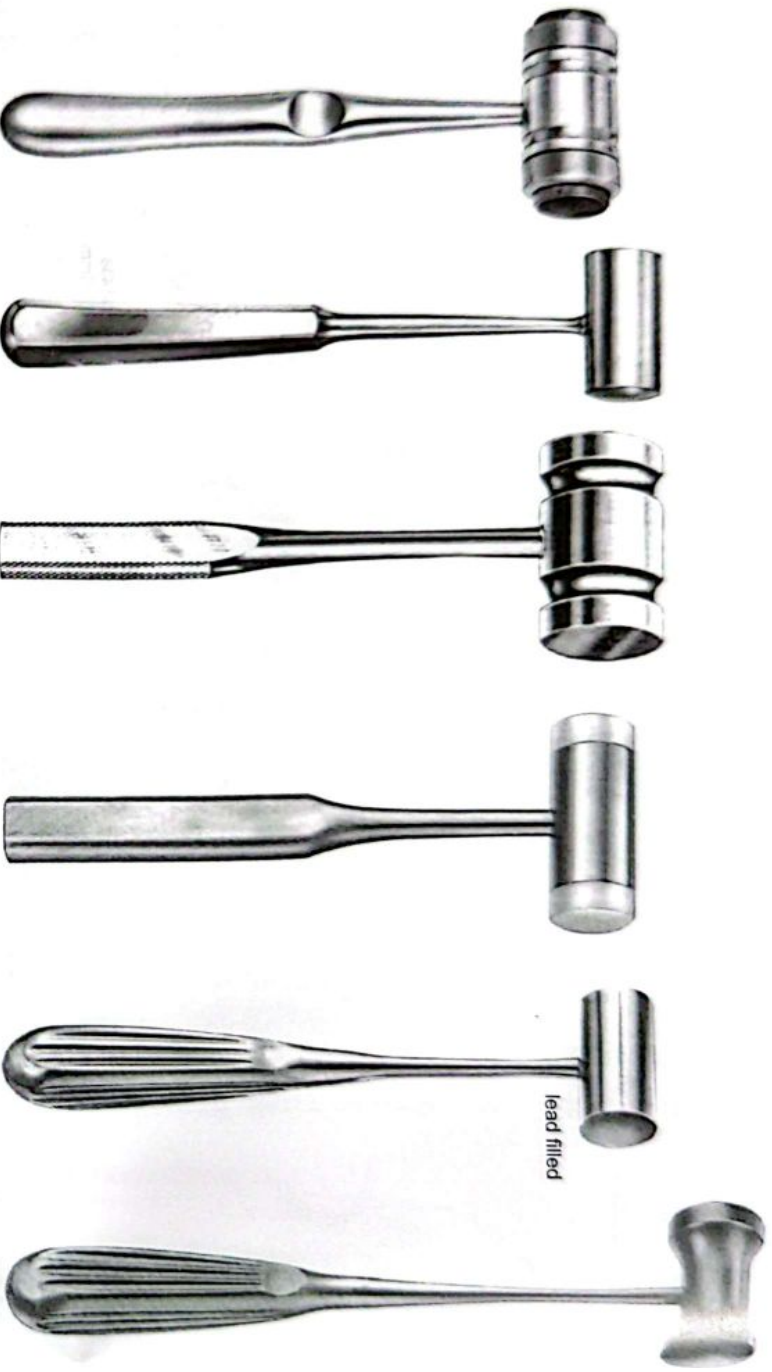

lead filled

Mead
09-1501
19 cm
Ø 27 mm 300 g

Patsch
09-1502
19 cm
Ø 27 mm 300 g

09-1503 250 g
09-1504 450 g
26.5 cm

09-1505
18.5 cm
25mm Ø 135 g

09-1506
19 cm
22mm Ø 155 g

Halek
09-1507
22 cm,
27mm Ø 130 g

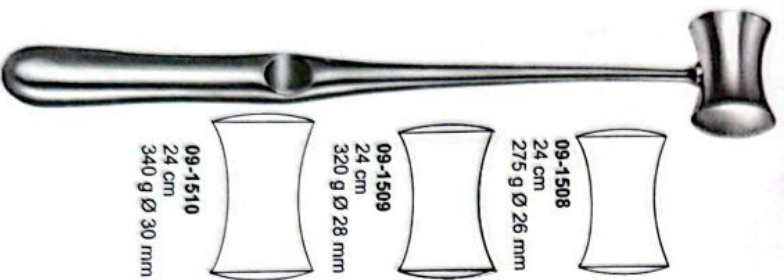

09-1508
24 cm
275 g Ø 26 mm

09-1509
24 cm
320 g Ø 28 mm

09-1510
24 cm
340 g Ø 30 mm

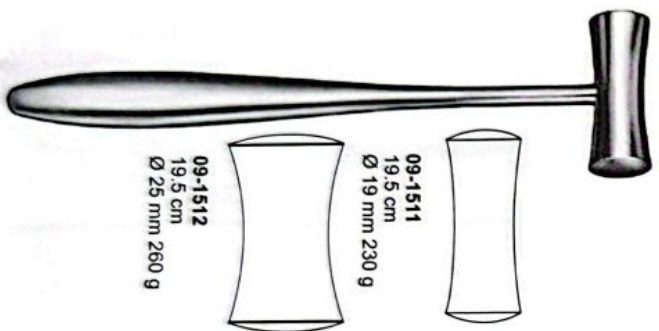

09-1511
19.5 cm
Ø 19 mm 230 g

09-1512
19.5 cm
Ø 25 mm 260 g



Collin
09-1513
20 cm
220 g Ø 30 mm



Cottle
09-1514
19 cm
Ø 30 mm 300



Williger
09-1515
19 cm
Ø 20mm

Williger
09-1508-09-1510

Lucae
09-1511-09-1512



Osteotomes, Chisels, Gouges,
Spongiosa Gouges

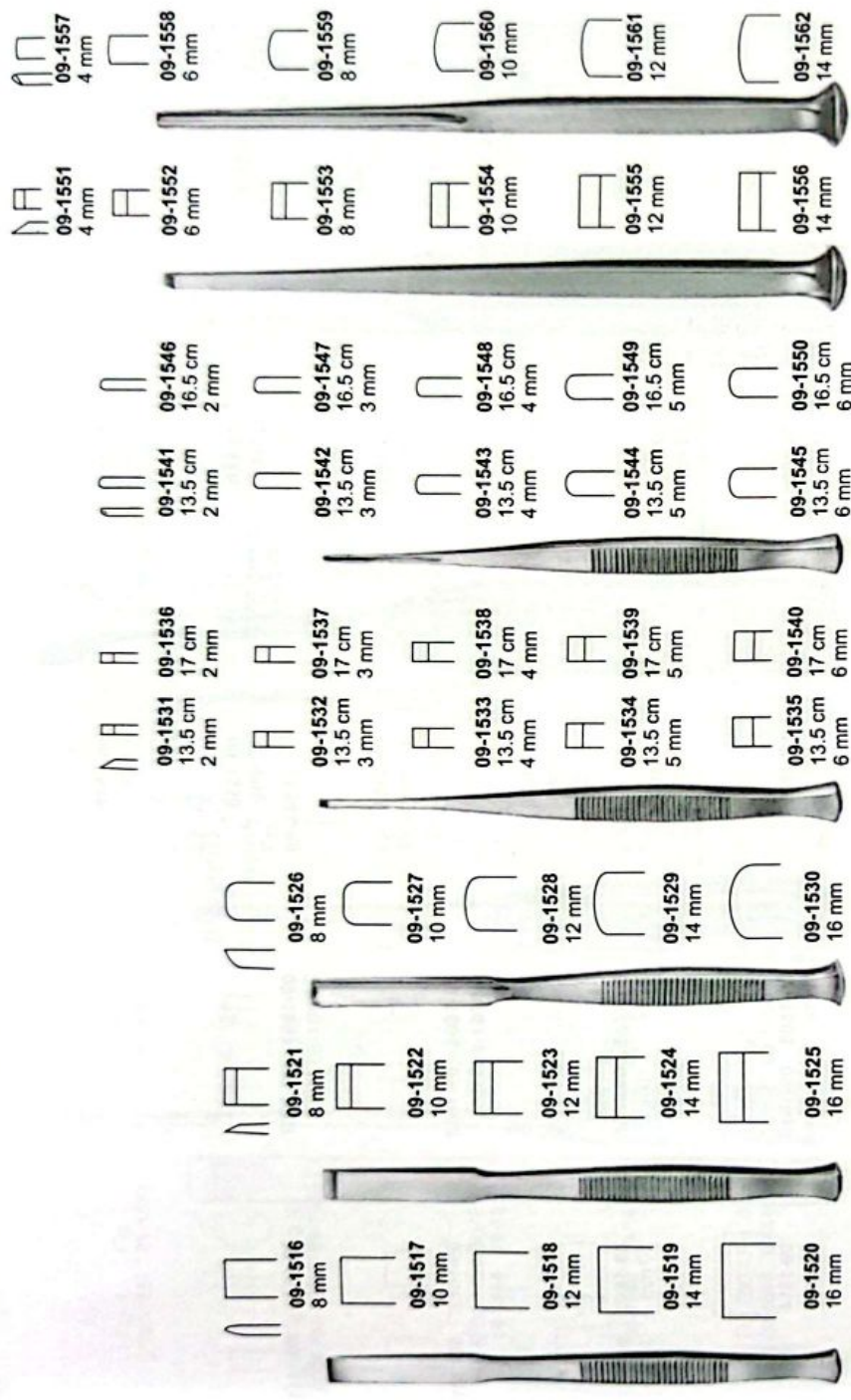

Stille
09-1563-09-1566
20.5 cm

Stille
09-1567-09-1570
20.5 cm

Stille
09-1571-9-1554
20.5 cm

Partsch
09-1531-09-1540

Partsch
09-1541-09-1550

Alexander
09-1551-09-1556
17.5 cm

Alexander
09-1557-09-1562
17.5 cm

Stille
09-1563
10 mm

Stille
09-1567
10 mm

Stille
09-1571
10 mm

Stille
09-1575
5 mm

Stille
09-1578
5 mm

Stille
09-1581
4 mm

Stille
09-1582
6 mm

Stille
09-1564
15 mm

Stille
09-1568
15 mm

Stille
09-1572
15 mm

Stille
09-1576
10 mm

Stille
09-1579
10 mm

Stille
09-1583
8 mm

Stille
09-1584
10 mm

Stille
09-1565
20 mm

Stille
09-1569
20 mm

Stille
09-1573
20 mm

Stille
09-1577
15 mm

Stille
09-1580
15 mm

Stille
09-1585
12 mm

Stille
09-1586
12 mm

Stille
09-1563-09-1566
20.5 cm

Stille
09-1567-09-1570
20.5 cm

Stille
09-1571-9-1554
20.5 cm

Lexer
09-1575-09-1577
24.5 cm

Lexer
09-1578-09-1580
24.5 cm

Lexer-Mini
09-1581-09-1585
18 cm



Osteotomes, Gouges

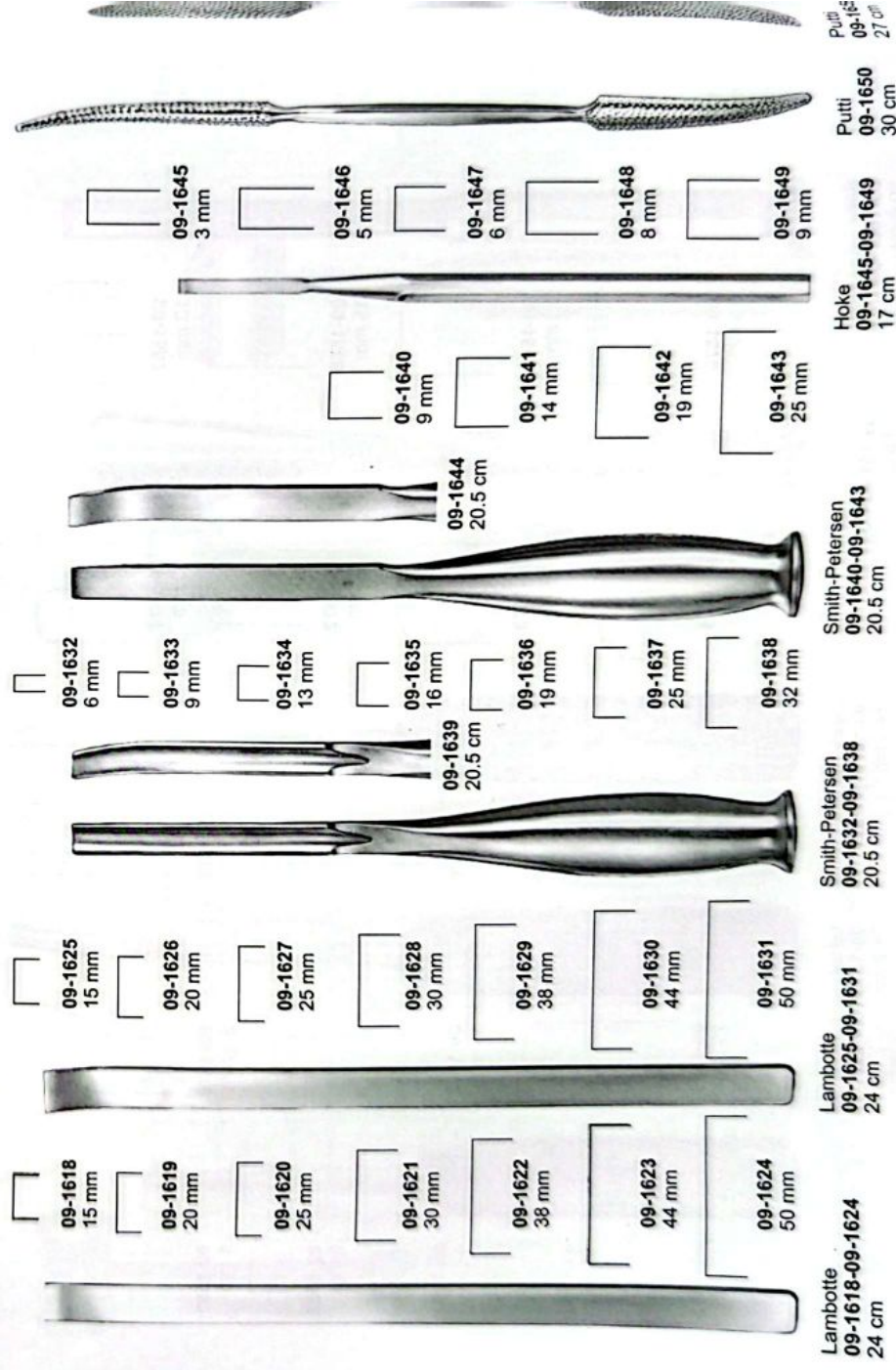
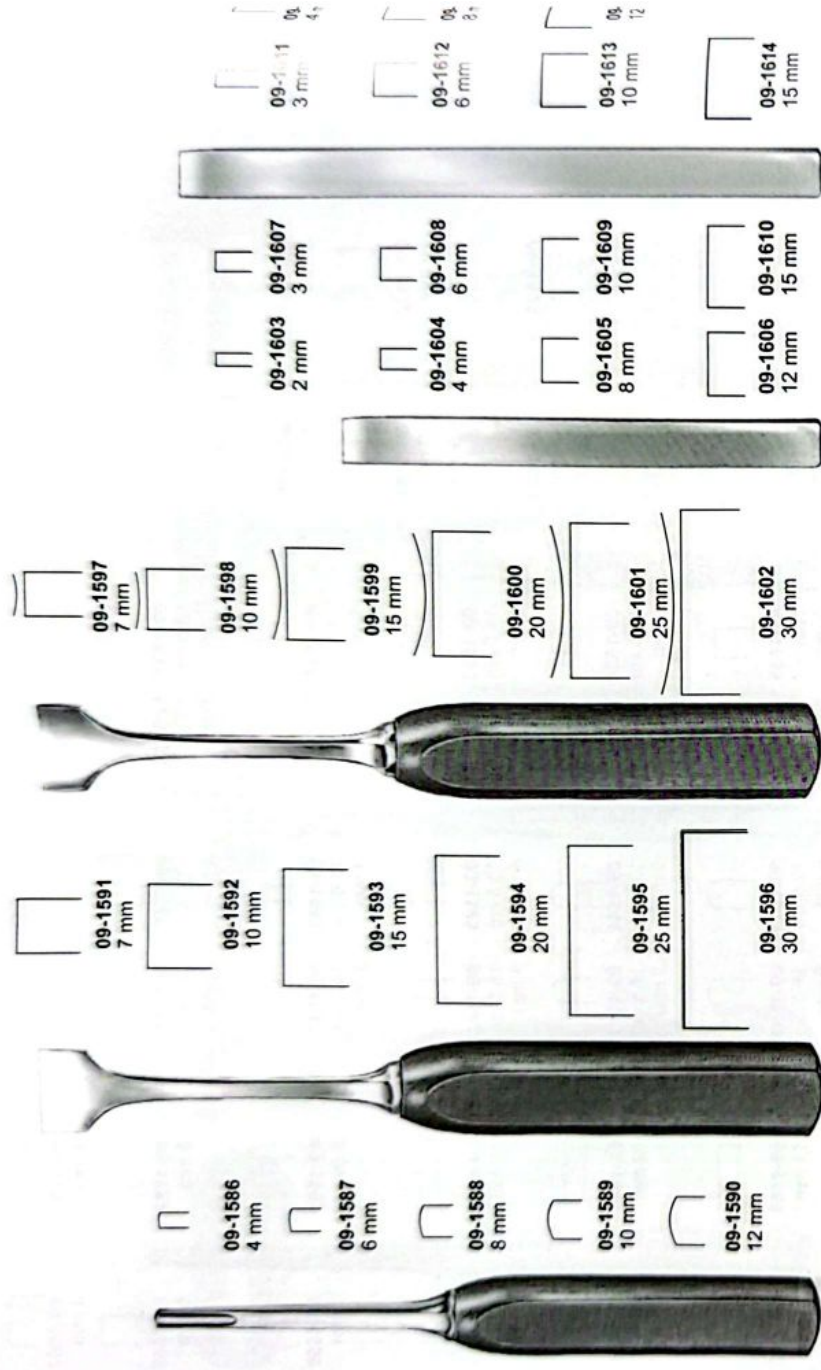

Bone Curettes

Fig. 1 09-1652	Fig. 2 09-1653	Fig. 1 09-1662	Fig. 0 09-1667	Fig. 0 09-1674	Fig. 00 09-1675	Fig. 00 09-1684	Fig. 00 09-1685
Fig. 3 09-1654	Fig. 4 09-1655	Fig. 2 09-1663	Fig. 00 09-1668	Fig. 000 09-1676	Fig. 0000 09-1677	Fig. 000 09-1686	Fig. 0000 09-1687
Fig. 5 09-1656	Fig. 6 09-1657	Fig. 3 09-1664	Fig. 1 09-1670	Fig. 1 09-1678	Fig. 2 09-1679	Fig. 1 09-1688	Fig. 2 09-1689
Fig. 0 09-1658	Fig. 00 09-1659	Fig. 4 09-1665	Fig. 2 09-1671	Fig. 3 09-1680	Fig. 4 09-1681	Fig. 3 09-1690	Fig. 4 09-1691
Fig. 000 09-1660	Fig. 0000 09-1661	Fig. 0 09-1666	Fig. 3 09-1672	Fig. 5 09-1682	Fig. 6 09-1683	Fig. 5 09-1692	Fig. 6 09-1693

Volkman
09-1652-09-1661
17 cm

Volkman
09-1662-09-1666
27 cm

Schede
09-1667-09-1673
17 cm

Volkman
09-1674-09-1683
17 cm

Bruns
09-1684-09-1693
17 cm

Fig. 0 09-1694	Fig. 00 09-1695	09-1703	Fig. 1 09-1706	Fig. 1 09-1712	Fig. 1 09-1718
Fig. 000 09-1696	Fig. 1 09-1697	09-1704	Fig. 2 09-1707	Fig. 2 09-1713	Fig. 2 09-1719
Fig. 2 09-1698	Fig. 3 09-1699	09-1705	Fig. 3 09-1708	Fig. 3 09-1714	Fig. 3 09-1720
Fig. 4 09-1700	Fig. 5 09-1701		Fig. 4 09-1709	Fig. 4 09-1715	Fig. 4 09-1721
Fig. 6 09-1702			Fig. 5 09-1710	Fig. 5 09-1716	Fig. 5 09-1722
			Fig. 6 09-1711	Fig. 6 09-1717	Fig. 6 09-1723

Volkman
09-1694-09-1702
23 cm

Volkman
09-1703-09-1705
25 cm

Modell USA
09-1706-09-1711
16.5 cm

Modell USA
09-1712-09-1717
16 cm

Modell USA
09-1718-09-1723
16.5 cm



Bone Curettes



Fig. 1
09-1724

Halle
09-1724-09-1726
21 cm



Fig. 2
09-1725

Volkman
09-1727-09-1729



09-1727 12.5 cm 09-1728 14.5 cm 09-1729 17 cm



09-1730 13 cm

Volkman
09-1730-09-1732

09-1731 16 cm

09-1732 20 cm



Fig. 1
09-1733

Fig. 2
09-1734

Fig. 3
09-1735

Fig. 4
09-1736

Fig. 5
09-1737

Fig. 6
09-1738

Simon
09-1733-09-1738
22.5 cm



Fig. 00/0 09-1739 Fig. 0/1 09-1740 Fig. 1/2 09-1741

Williger
09-1739-09-1741
14 cm



Fig. 00/00 09-1742 Fig. 0/0 09-1743 Fig. 1/1 09-1744

Williger
09-1742-09-1744
16.5 cm



Molt
09-1745-09-1749



Fig. 1
09-1745
17 cm



Fig. 2
09-1746
17 cm



Fig. 4
09-1747
17 cm

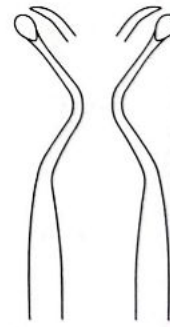

Fig. 5
09-1748
17.5 cm



Fig. 6
09-1749
17.5 cm



Molt
09-1750
19 cm



Periosteal Elevators



Langenbeck
09-1751
18 cm

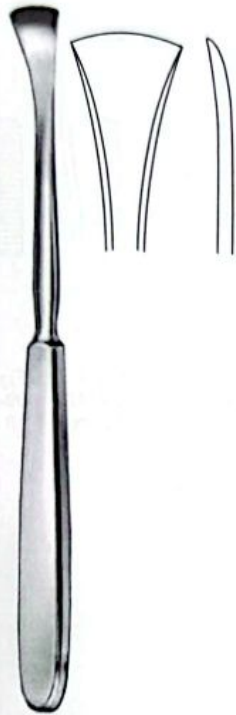

Langenbeck
09-1752
19 cm

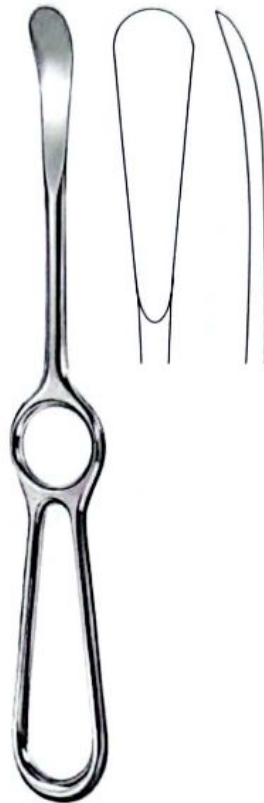

Sedillot
09-1753
22 cm



Farabeuf
09-1754
15.5 cm



Farabeuf
09-1755
15.5 cm



Williger
09-1756
12.5 cm
6 mm



4 mm
09-1757
16.5 cm

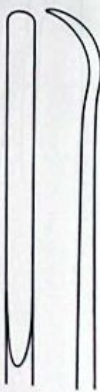

5 mm
09-1758
16.5 cm



Williger
09-1759
16 cm
7 mm



Williger
09-1760
16 cm
5 mm



Alexander
09-1761
21 cm



Semb
09-1762



Doyen
09-1763-09-1766
17.5 cm

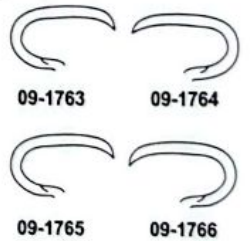

09-1763

09-1764

09-1765

09-1766

Bone Files, Elevators



09-1767
28 cm



09-1768
25 cm



09-1769
22 cm



Miller-Colburn
09-1770-09-1774
18 cm



Fig. 1
09-1770
18 cm



Fig. 2
09-1771
18 cm



Fig. 3
09-1772
18 cm



Fig. 4
09-1773
18 cm



Fig. 5
09-1774
18 cm



Alderdyce
09-1775
21 cm



Miller-Colburn
09-1776-09-1779
18 cm



Fig. 1
09-1776
18 cm



Fig. 2
09-1777
18 cm



Fig. 3
09-1778
18 cm



Fig. 4
09-1779
18 cm



Langenbeck
09-1780-09-1781
19.5 cm



09-1780
19.5 cm
7mm



09-1781
19.5 cm
10mm



Williger
09-1782
17 cm
7mm



Williger
09-1783
16 cm
4mm



McDonald
09-1784
18.5 cm



Bone Levers

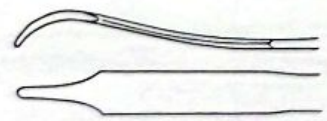

09-1785
16 cm
6 mm

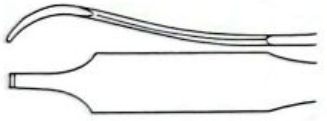

09-1786
16 cm
8 mm



Hohmann
09-1787
21.5 cm
8 mm

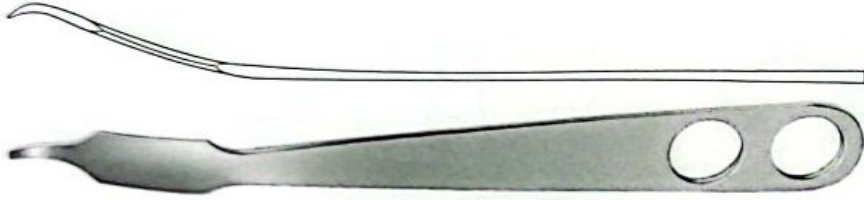

Hohmann
09-1788
23.5 cm
18 mm

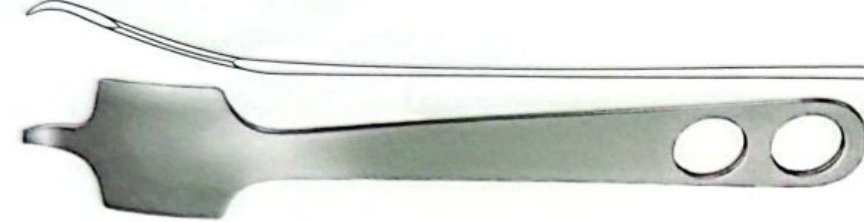

Hohmann
09-1789
23.5 cm
43 mm



Hohmann
09-1790
29 cm
35 mm



Hohmann, mini
09-1785-09-1786
16 cm

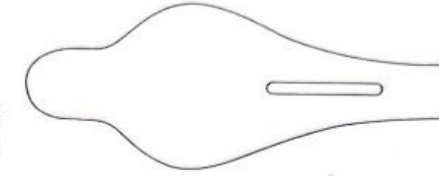

09-1795
23.5 cm
60 mm

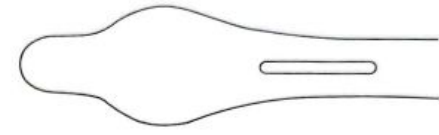

09-1794
24 cm
43 mm



Benneit
09-1794-09-1795
24 cm

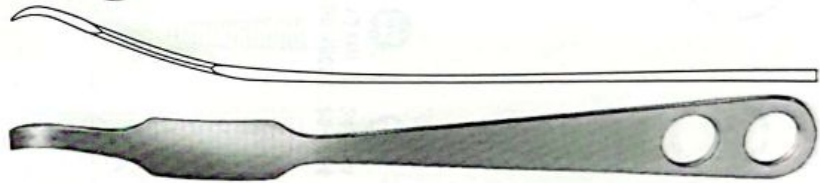

Hohmann
09-1793
25.5 cm
22 mm

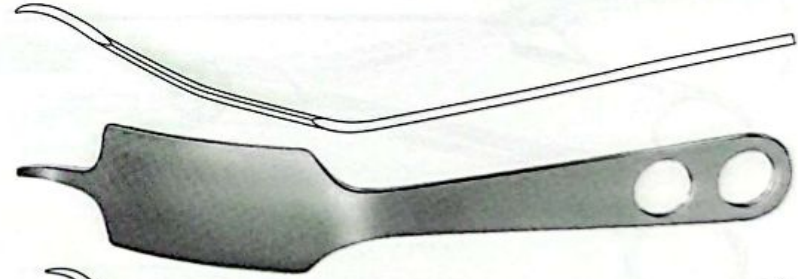

Hohmann
09-1792
23.5 cm
43 mm

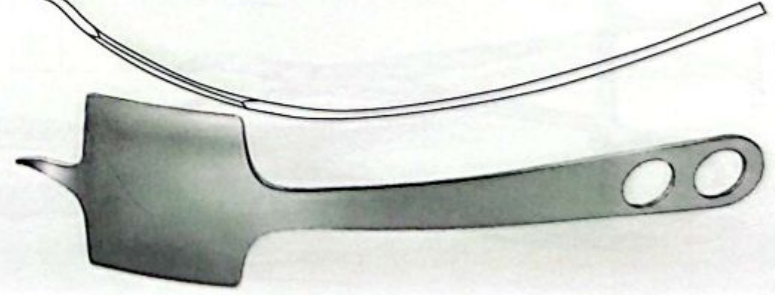

Hohmann
09-1791
25 cm
70 mm

Knee Retractors, Spinal Retractors Tendon Holding Forceps, Tendon Tunnelling Forceps



Blount
09-1796
26.5 cm
39 mm



Blount
09-1797
26.5 cm
47 mm



Blount
09-1798
17.5 cm

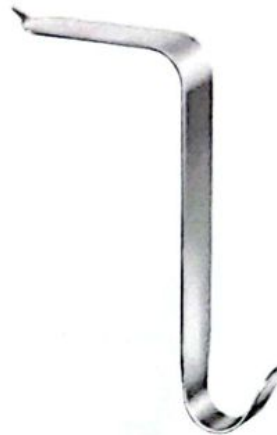
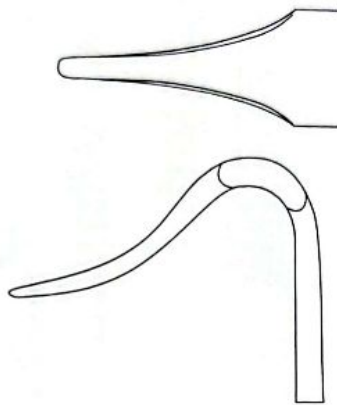

Taylor
09-1799-09-1800
16 cm

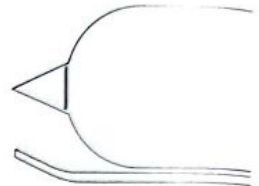

09-1799
16 cm
95 x 30 mm

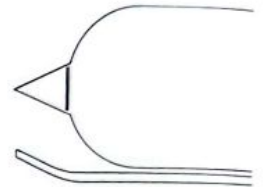

09-1800
16 cm
115 x 30 mm

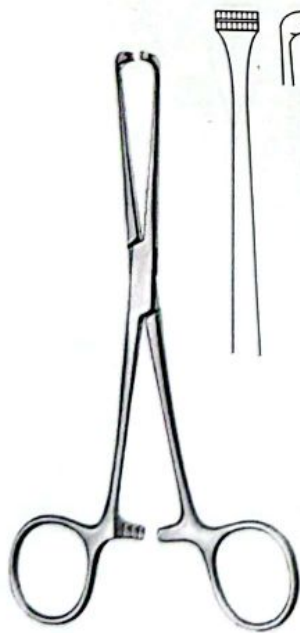

Steinmann
09-1801
16 cm

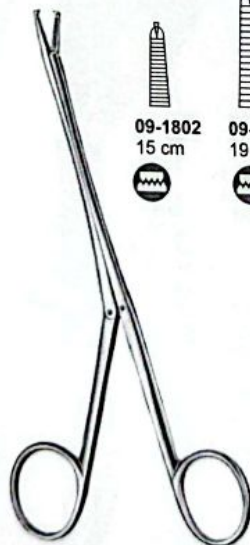

Brand
09-1802-09-1804

09-1802
15 cm

09-1803
19 cm

09-1804
24.5 cm



Kleinert-Kutz
09-1805
21 cm
140 mm



09-1806
14.5 cm



Cartilage Seizing Forceps, Bone Holding Forceps

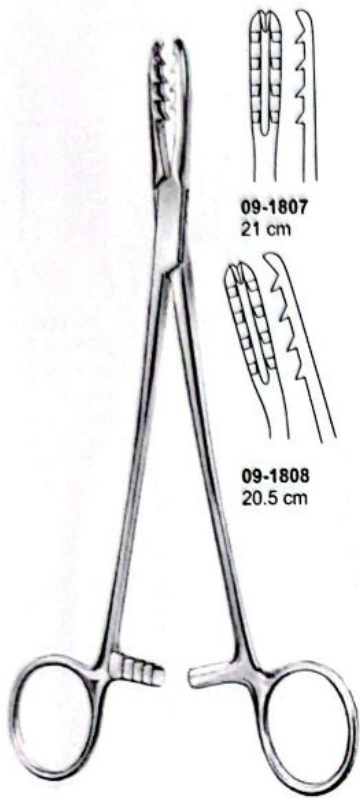

09-1807
21 cm

09-1808
20.5 cm

Bircher-Ganske
09-1807-09-1808

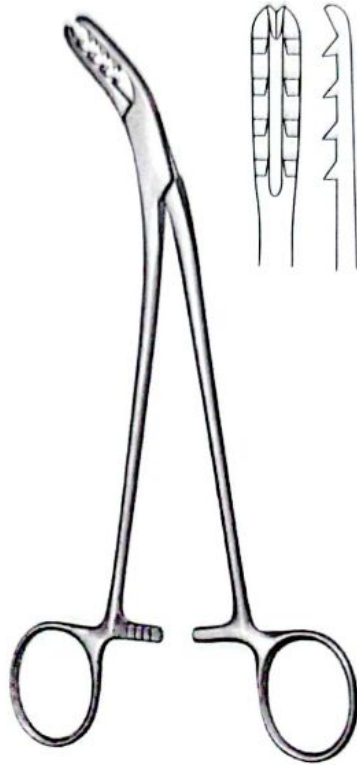

Bircher-Ganske
09-1809
20 cm

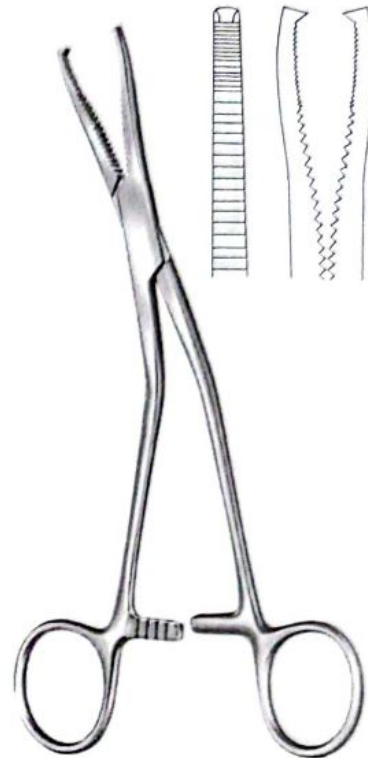

Dingmann
09-1810
18.5 cm



Langenbeck
09-1811
21 cm

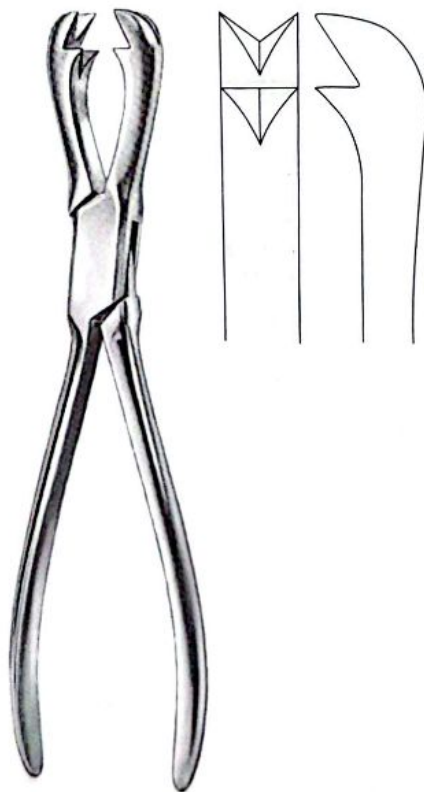

Fergusson
09-1812
21 cm



Frosch
09-1813
18 cm



09-1814
20 cm



Bone Holding Forceps, Reposition Forceps

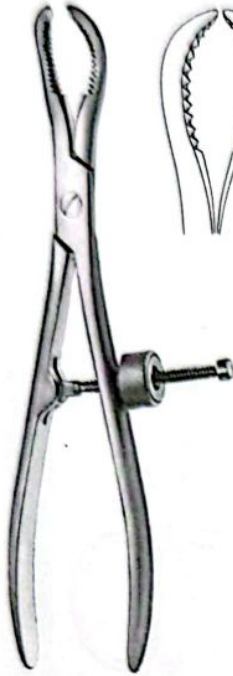

09-1815
17.5 cm

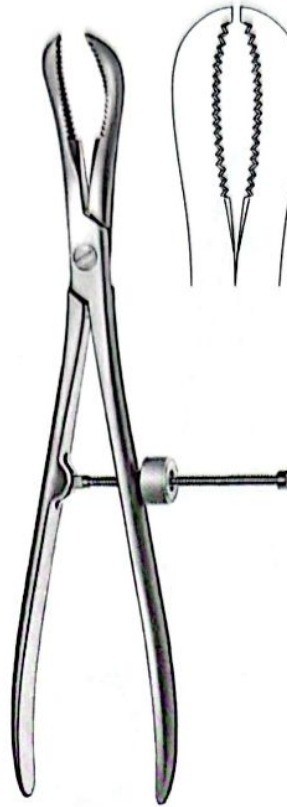

09-1816
24 cm



Kern
09-1817-09-1818
24 cm

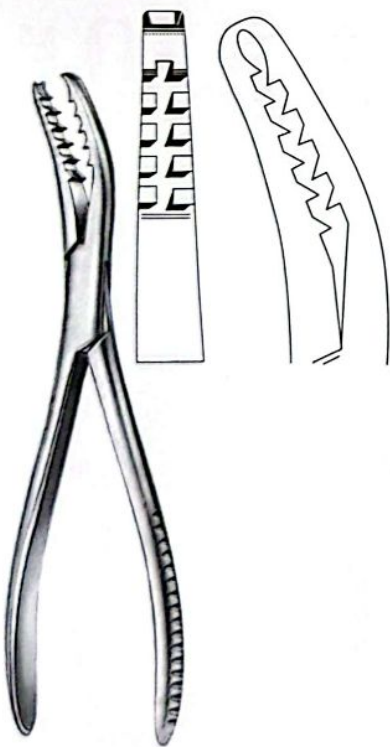

Semb
09-1819
19.5 cm

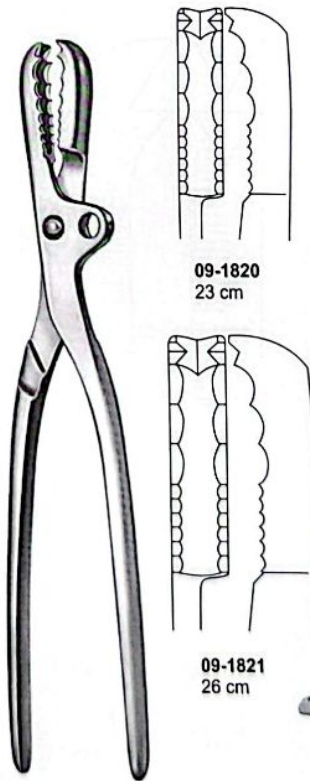

Farabeuf
09-1820-09-1821
19.5 cm

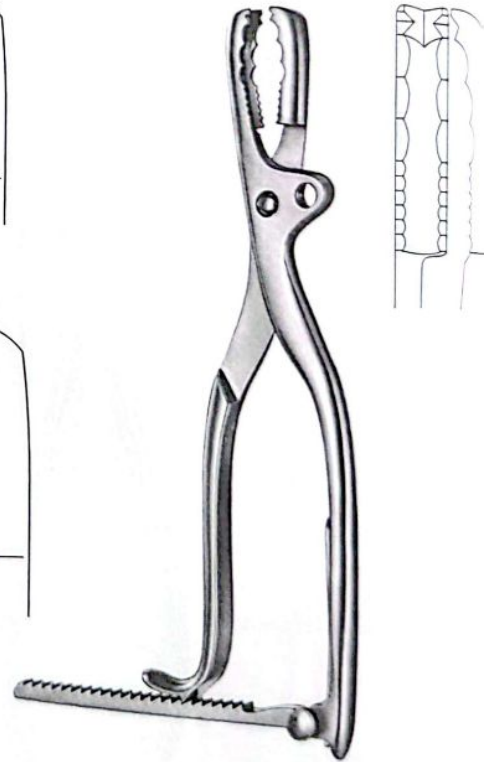

Farabeuf
09-1822
19.5 cm



Bone Holding Forceps, Amputation Retractor

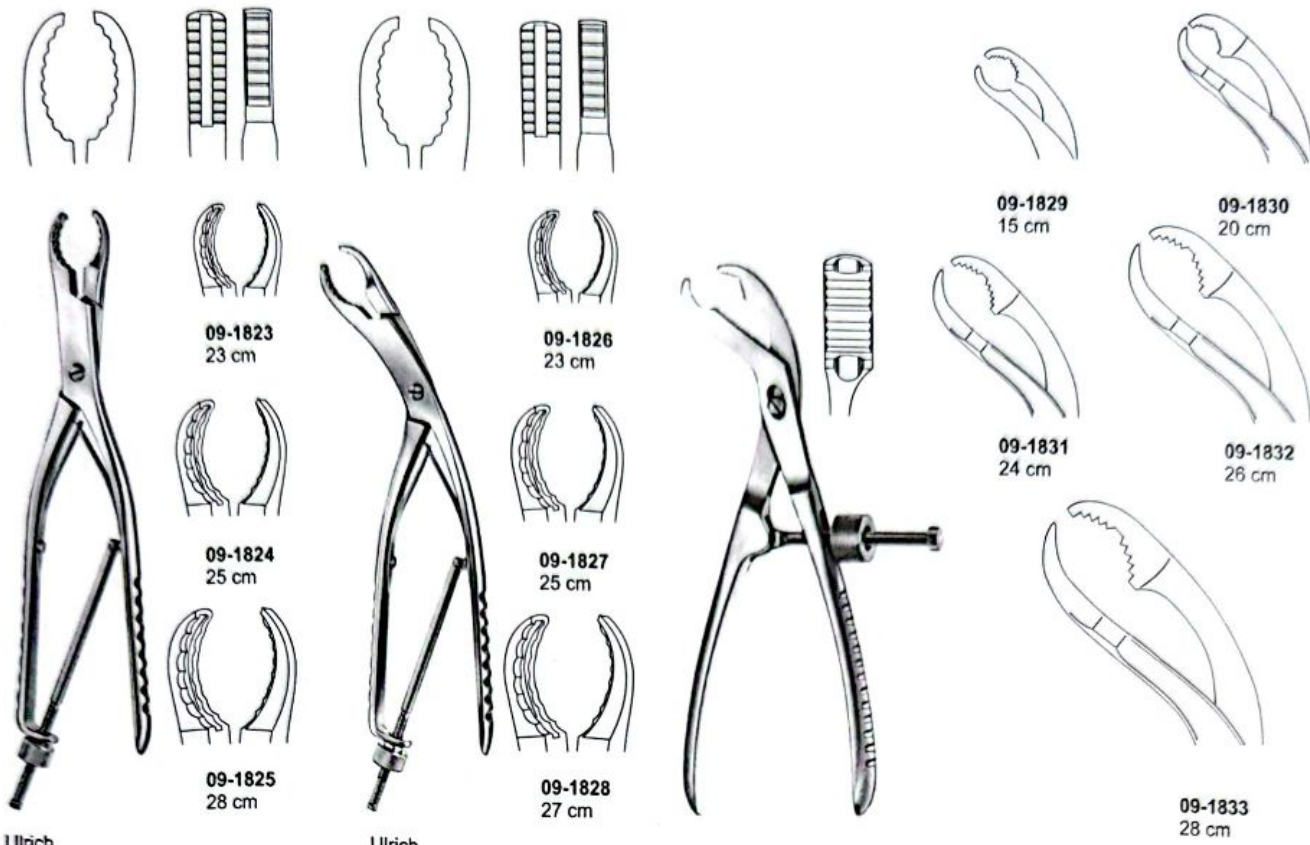

Ulrich
09-1823-09-1825

Ulrich
09-1826-09-1828

09-1829-09-1833

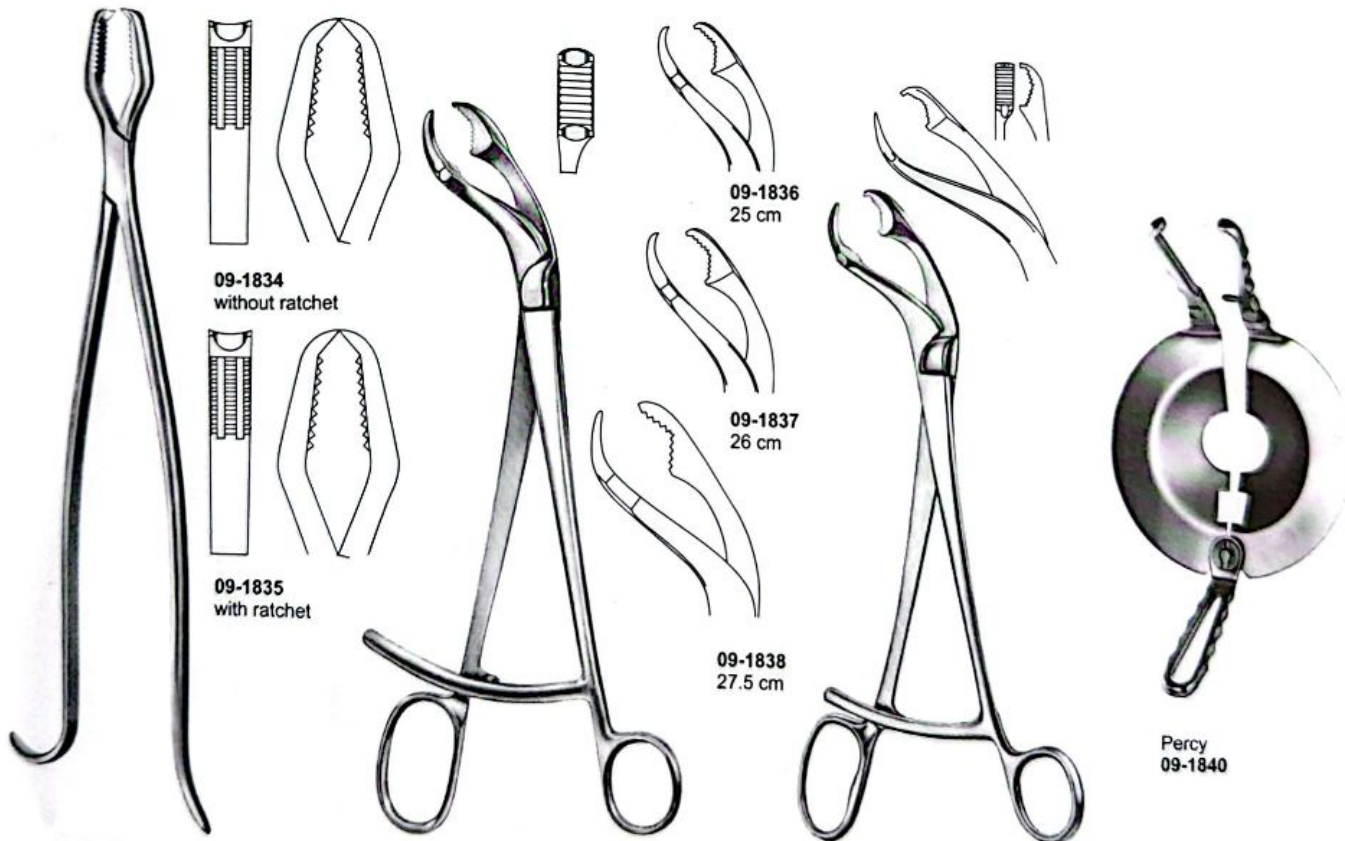

Lane
09-1834-09-1835
33 cm

Verbrugge
09-1836-09-1838

Verbrugge
09-1839
17.5 cm

Percy
09-1840



Bone Rongeurs

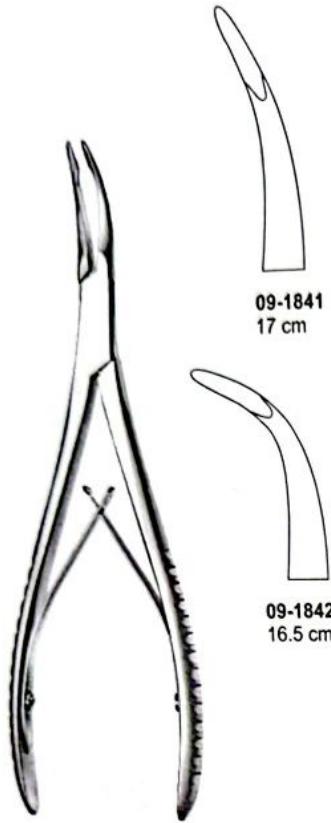

09-1841
17 cm

09-1842
16.5 cm

Stellbrink
09-1841



Friedmann
09-1843
12.5 cm



Friedmann
09-1844
13.5 cm



Friedmann
09-1845
13.5 cm

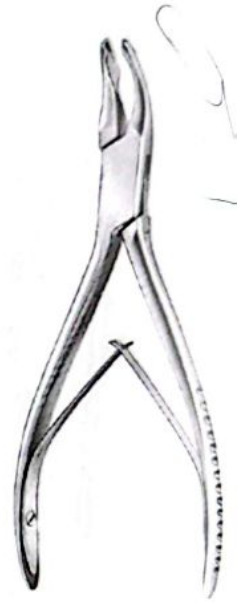

Cleveland
09-1846
13.5 cm



Cleveland
09-1847
16.5 cm



Mead
09-1848
16.5 cm



Hartmann
09-1849
17.5 cm

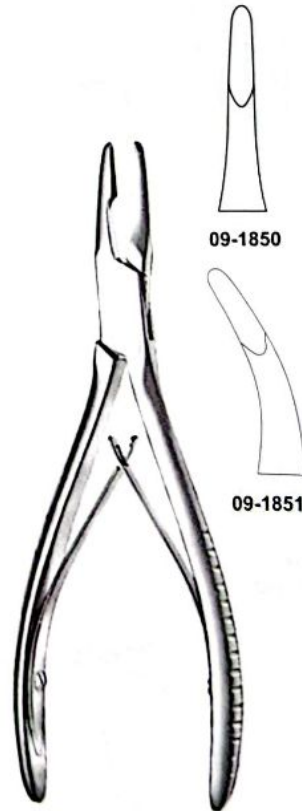

Jansen
09-1850-09-1851
18 cm

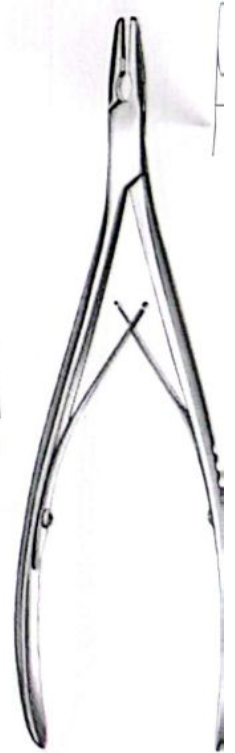

Lempert
09-1852
19 cm



Bone Rongeurs

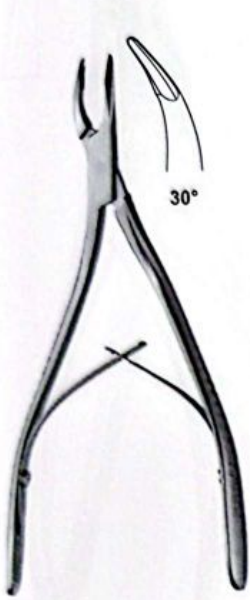

09-1853
14.5 cm

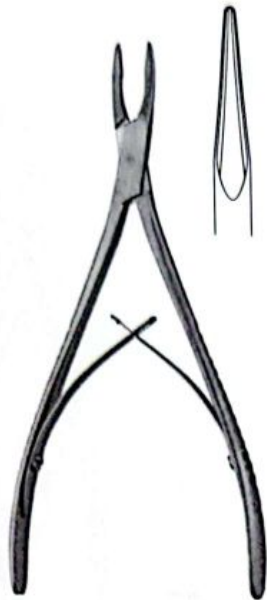

09-1854
15.5 cm

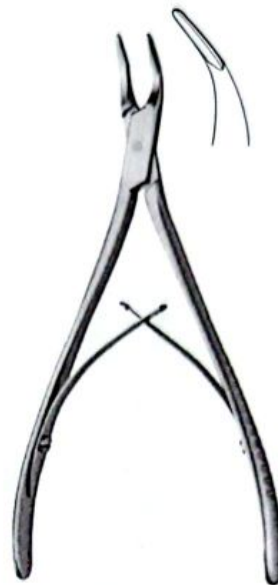

09-1855
15.5 cm



09-1856
14.5 cm



Blumenthal
09-1857-09-1859



09-1857
16 cm



09-1858
15.5 cm

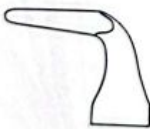

09-1859
15.5 cm



Luer
09-1860-09-1861



09-1860
18.5 cm



09-1861
18 cm



Luer
09-1862-09-1864



09-1862
14.5 cm



09-1863
14.5 cm



09-1864
14.5 cm



Bone Rongeurs

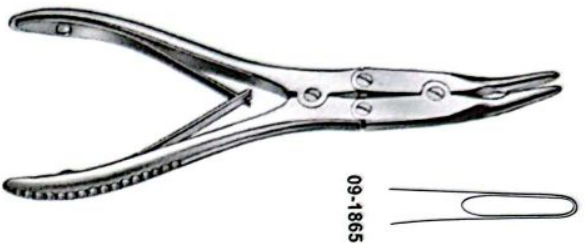

Bohler
09-1865-09-1866
15 cm

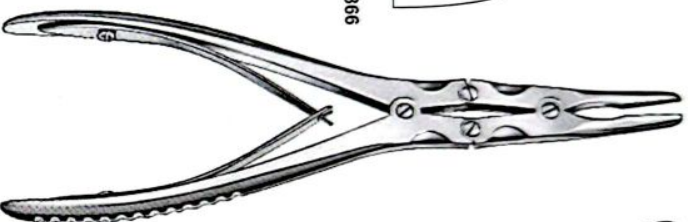

Beyer
09-1867
18 cm



Zaufal-Jansen
09-1868
18 cm



Mayfield
09-1869
18 cm



Marcjeu
09-187
20.5 cm



Ruskin
09-1871
19 cm



Ruskin
09-1872
24 cm



Semb
09-1873
23.5 cm

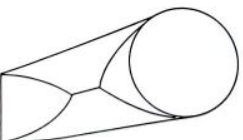

Stille
09-1874
22.5 cm



Bone Rongeurs

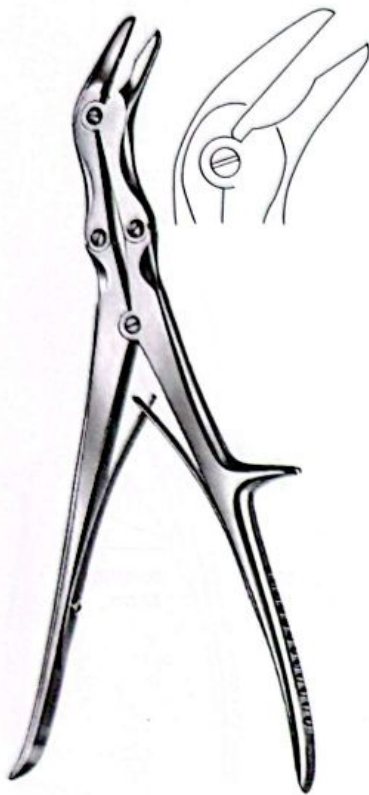

Echlin
09-1875-09-1877
23 cm



09-1875



09-1876



09-1877



Stille-Ruskin
09-1878
23.5 cm



Leksell-Stille
09-1879-09-1880
24.5 cm



09-1879



09-1880



Frykholm
09-1881
24.5 cm

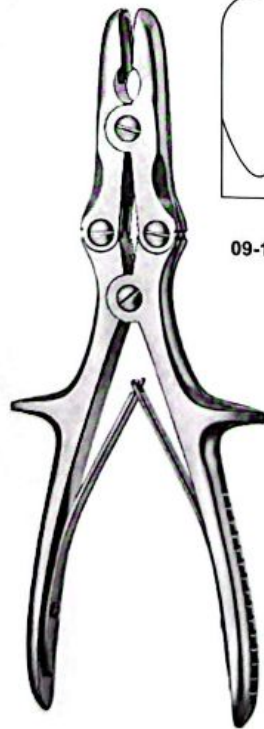

Stille-Luer
09-1882-09-1883
22.5 cm



09-1882



09-1883

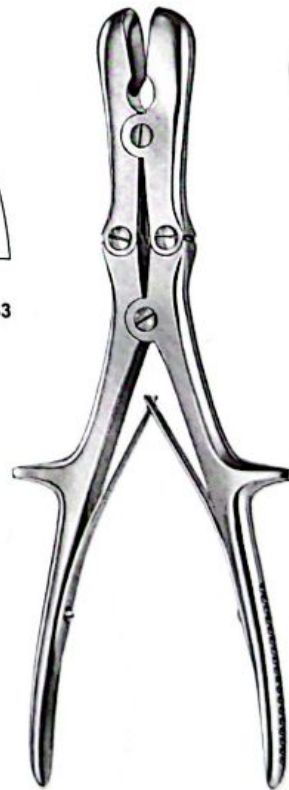

Stille-Luer
09-1884-09-1887



09-1884
23 cm

09-1886
27 cm



09-1885
23 cm

09-1887
27 cm





Cottle-Kazanjan
09-1888
19 cm



09-1889
14 cm



09-1890
17 cm



09-1893
14 cm



09-1894
17 cm



Liston
09-1889-09-1892
14 cm



09-1891
20 cm



09-1892
22 cm



Liston
09-1893-09-1896
14 cm



09-1895
20 cm



09-1896
22 cm



Cleveland
09-1897-09-1898
17 cm, 14.5 cm



09-1897



09-1898

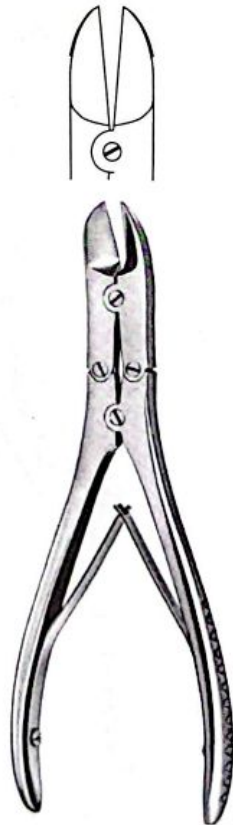

Ruskin-Liston
09-1899-09-1900



09-1899
19 cm



09-1900
18.5 cm



Stille-Liston
09-1901
26 cm



Bone Cutting Forceps



Stille-Liston
09-1902-09-1904

09-1902
28 cm



09-1903
23.5 cm



09-1904
28 cm

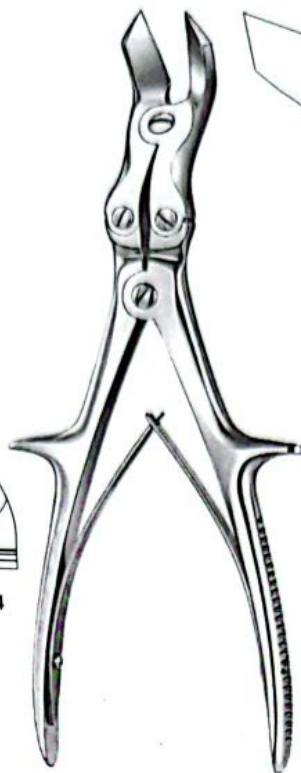

Liston-Key
09-1905
26 cm



Vickers
09-1906



Martin
09-1907
18.5 cm



Walton
09-1908
16 cm

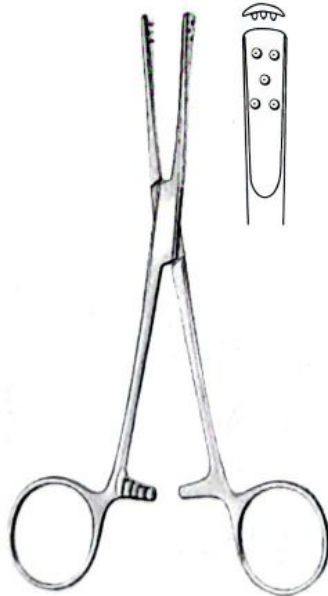

Penner
09-1909
16 cm



09-1910
14.5 cm



Radolf
09-1911
13.5 cm



Amputation Saws, Reamer, Hand Drills



Charrière
09-1912
35 cm



Langenbeck
09-1913
24 cm



Charrière
09-1914
26.5 cm



Satterlee
09-1915
29 cm



09-1916
13 cm



Perthes
09-1917
21.5 cm

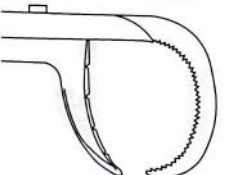

09-1919

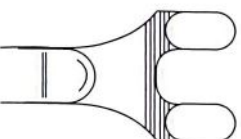

09-1920
18 cm / 7"

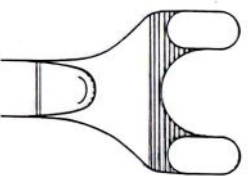

09-1921
20 cm / 8"

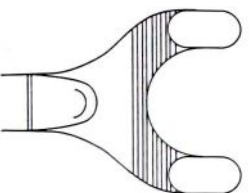

09-1922
22 cm / 8 7/8"

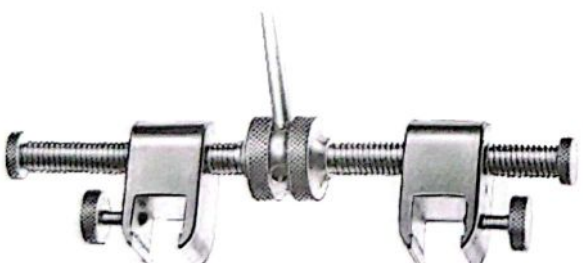

Gerster
09-1923



09-1924
18.5 cm

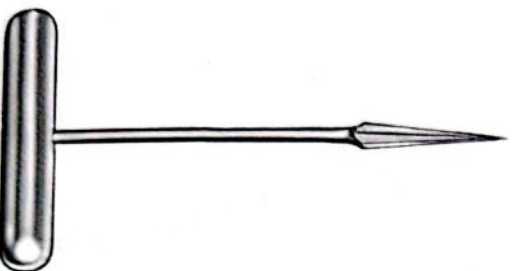

09-1918
14 cm



Gerster-Lowman
09-1919-09-1922

Vise Grip, Combi-Flat Nose Plier



09-1925
20,5 cm



09-1926
15 cm



09-1927-09-1929
18 cm



09-1927



09-1928



09-1929



09-1930
13.5 cm

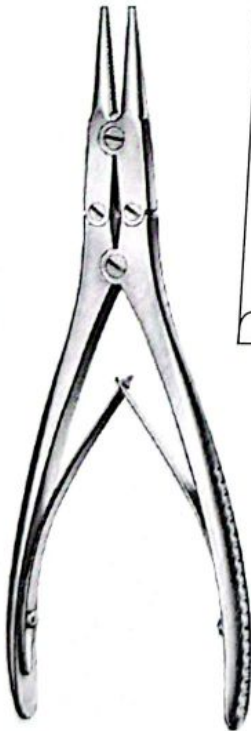

09-1931
19 cm

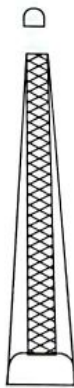

Hackstock
09-1932
16 cm



09-1933
17 cm



09-1934
19 cm



Wire Cutting Pliers, Wire Guides, Wire Tightener, Extension Bows

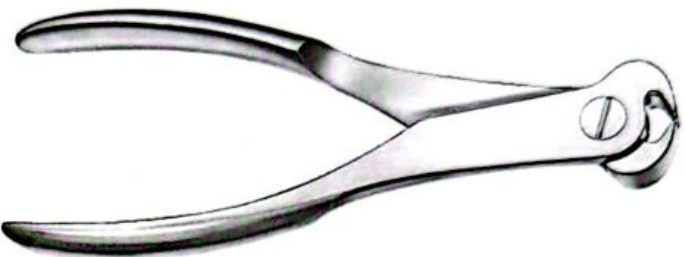

09-1935
18.5 cm

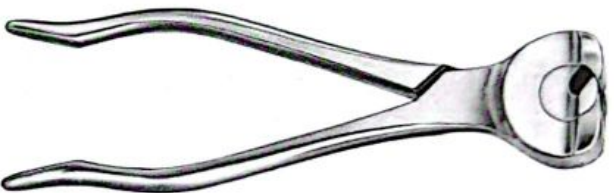

Martin "Diamant"
09-1936
16 cm



09-1937
55 cm



Demel
09-1938-09-1940



Fig. 1
09-1938
31 cm

Fig. 2
09-1939
29 cm

Fig. 3
09-1940
28 cm



Louie
09-1941
21 cm

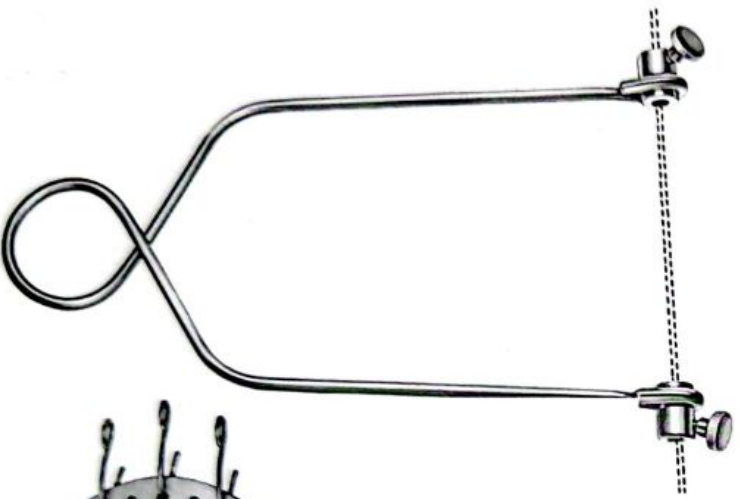

Böhler
09-1942

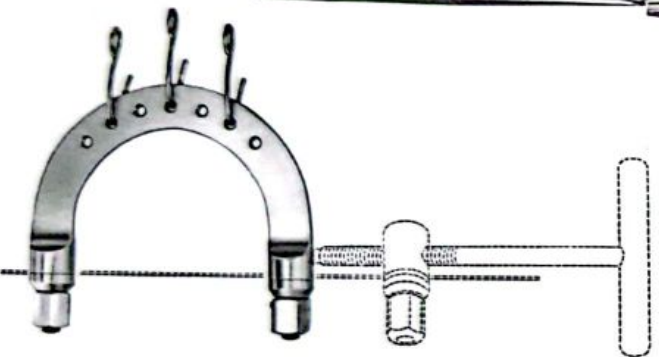

Kirschner
09-1943
95 x 70 mm



09-1944
18.5 cm



Kirschner
09-1945
18.5 cm



Kirschner
09-1946
95 x 70 mm



Bandage Scissors, Plaster Shears,
Plaster Knives, Plaster Breakers



Hopkins
10-2001
20 cm



Esmarch
10-2002
18 cm



Reiner
10-2003
18 cm



Martin
10-2004
20,5 cm



Wigmore
10-2005
19 cm



Hennig
10-2006
28 cm



Quattro
10-2007
23 cm

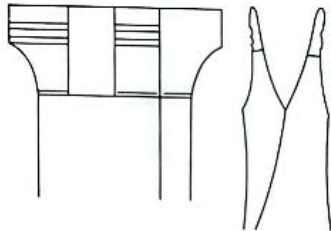

Wolff
10-2008-10-2009



10-2008
17,5 cm



10-2009
26,5 cm

Bandage Scissors, Plaster Shears,
Bandage Scissors

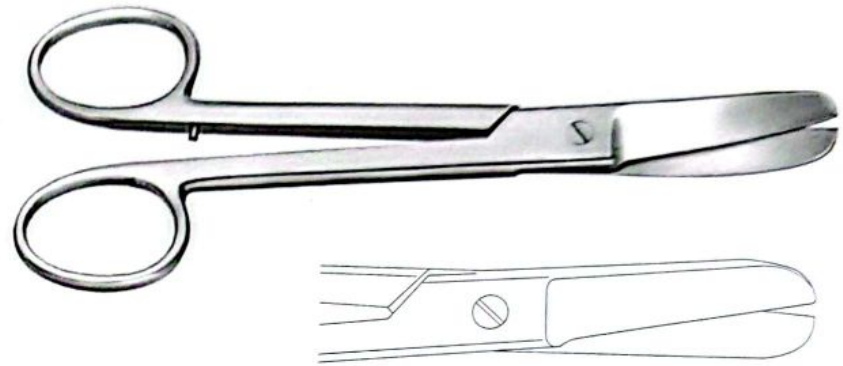

Lorenz
10-2010
24 cm

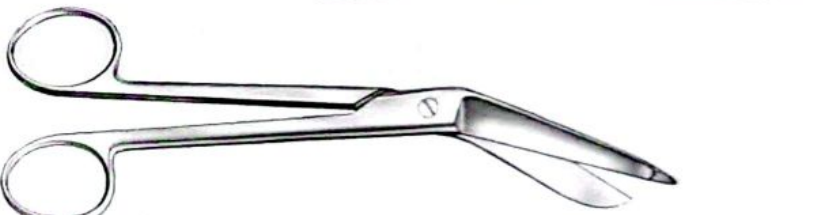

Lister
10-2011-2013

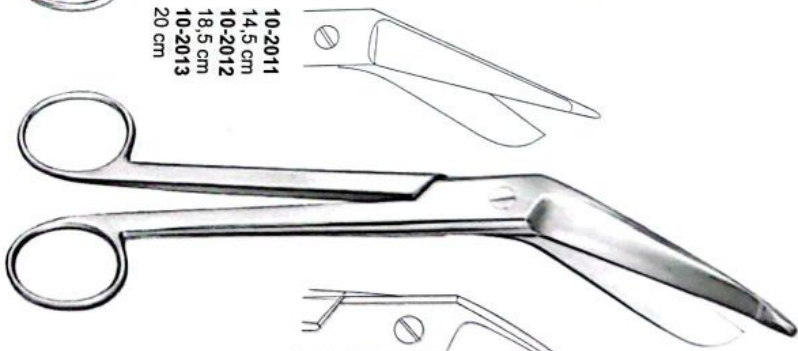

Bergmann
10-2014
23 cm

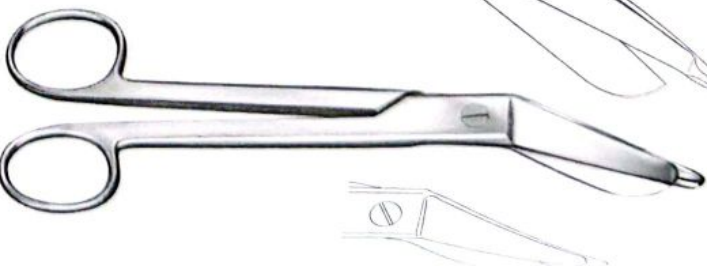

Esmarch
10-2015
20 cm

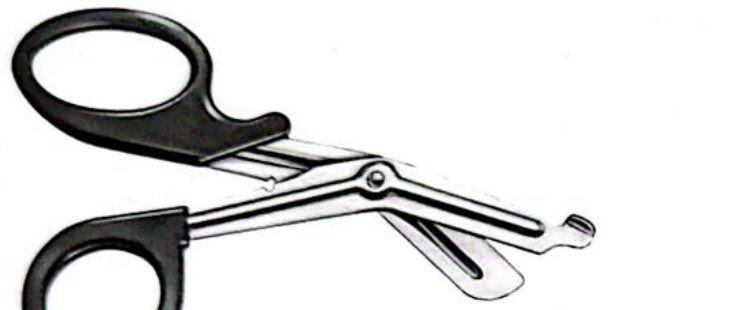

Universal
10-2016-10-2017
15,5 cm

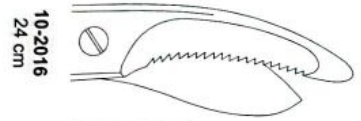

10-2016
24 cm



10-2017
24 cm

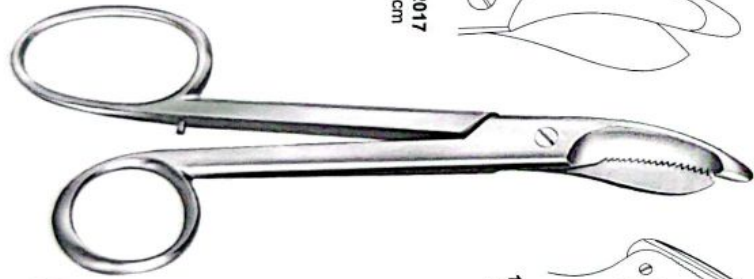

Brunns
10-2018-10-2020



10-2018
23 cm



10-2019
27 cm



10-2020
38 cm

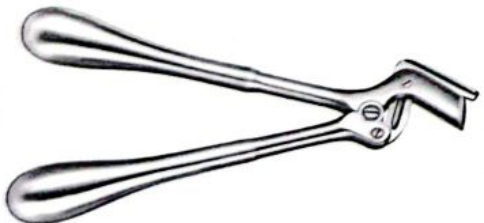

Stille-Martin
10-2021



Stille
10-2022
24 cm



Needle Holders



Derf
11-2101
12 cm



Collier
11-2102
12.5 cm

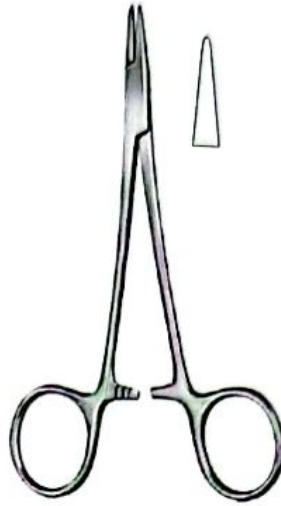

Webster
11-2103
13 cm



Halsey
11-2104
13.5 cm



Neivert
11-2105
12.5 cm

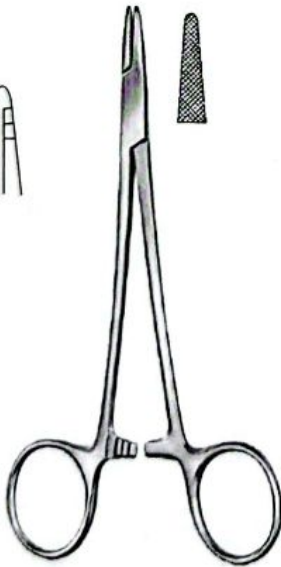

Hegar-Baumgartner
11-2106
14 cm

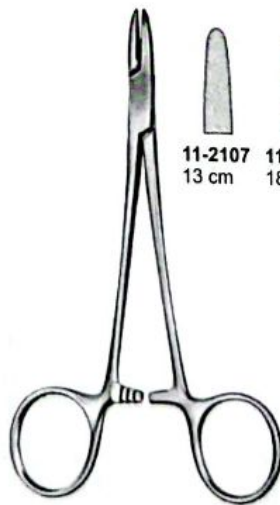

Brown
11-2107-11-2108
13 cm

11-2107
13 cm

11-2108
18 cm

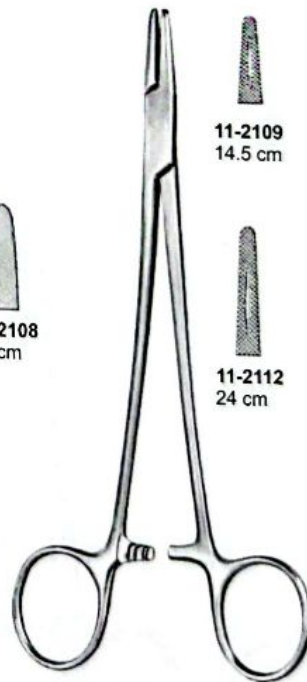

Mayo-Hegar
11-2109-11-2114

11-2109
14.5 cm

11-2110
16 cm

11-2111
18.5 cm

11-2112
24 cm

11-2113
26.5 cm

11-2114
30.5 cm



Needle Holders

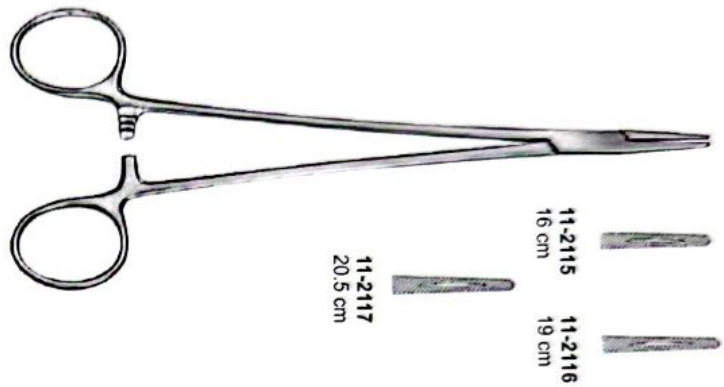

Mayo-Hegar
11-2115-11-2117

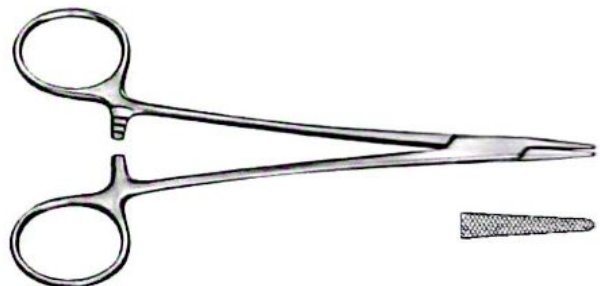

Crile-Murray
11-2118
15 cm



Crile-Wood
11-2119
15 cm



Hegar
11-2120
20 cm, 24 cm



Adson
11-2121
18.5 cm

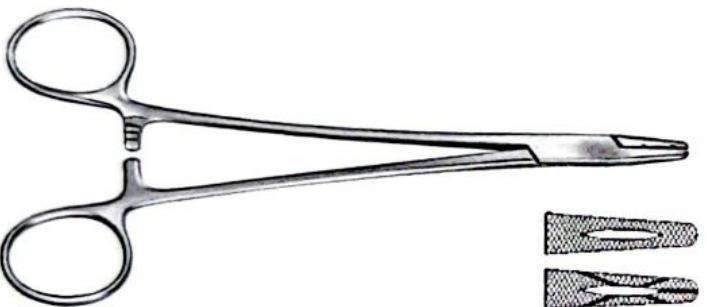

Meitzenbaum
11-2122
18.5 cm

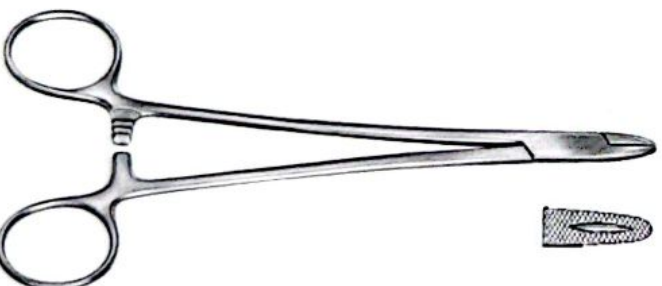

M. G. Hospital
11-2123
18 cm

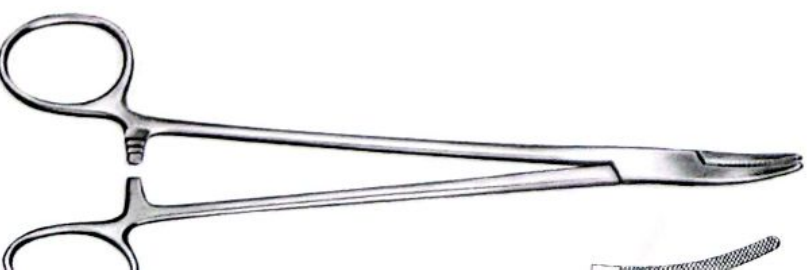

Heaney
11-2124
20.5 cm



Needle Holders

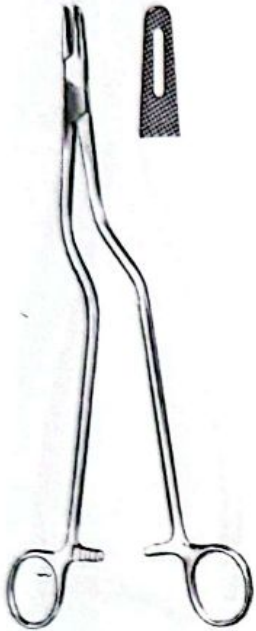

Masson-Luethy
11-2125
26 cm

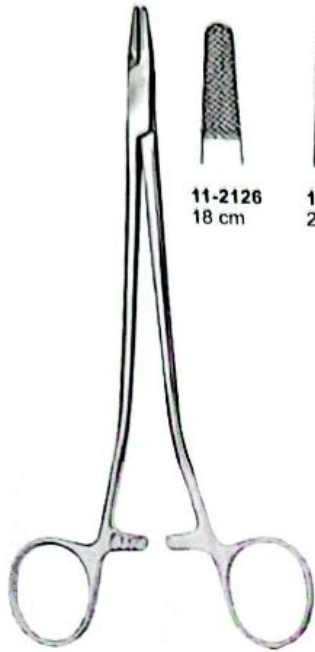

11-2126 18 cm
11-2127 20 cm
11-2128 26 cm

Sarot
11-2126-11-2128

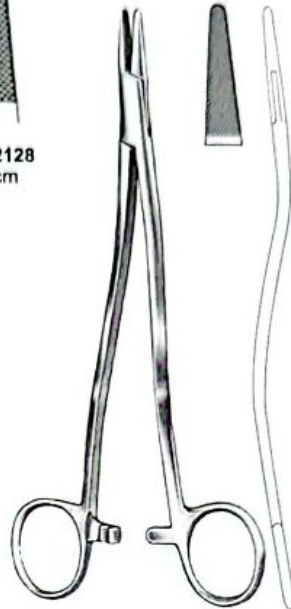

Wertheim
11-2129
20 cm, 24 cm



Stratte
11-2130
23 cm



Kilner
11-2131
14.5 cm

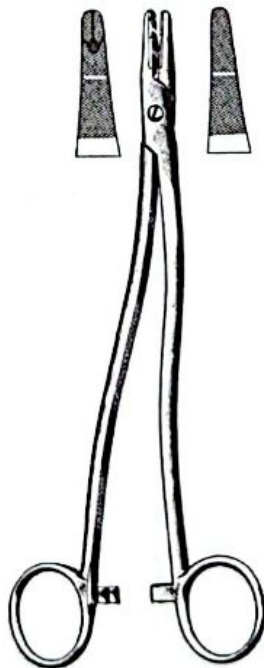

Bozemann
11-2132
20 cm, 24 cm



Wangenstein
11-2133
26.5 cm



Jamison
11-2134
23 cm



Needle Holders

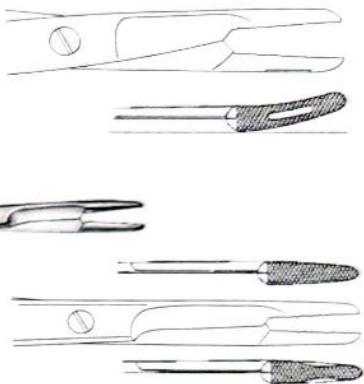

Gillies
11-2135
16 cm

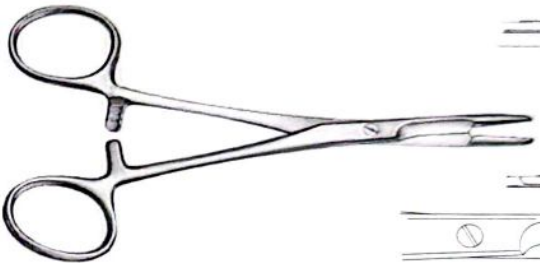

Olsen-Hegar
11-2136
14 cm

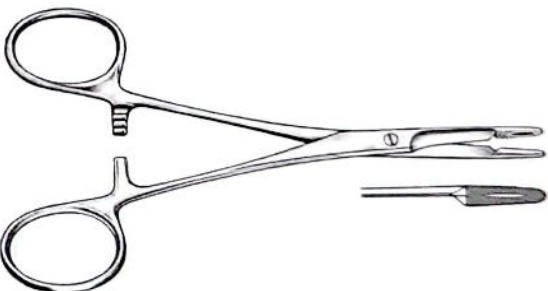

Olsen-Hegar
11-2137
14 cm



Crile
11-2138
15 cm



Toennis
11-2139
18.5 cm



Lichtenberg
11-2140
20 cm

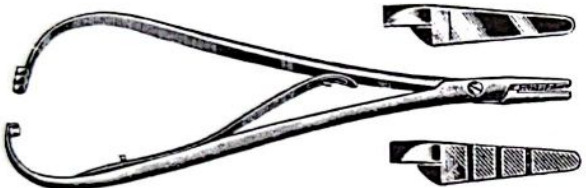

Macphail
11-2141
14 cm, 16 cm
11-2142
18 cm, 20 cm



Mathieu
11-2143-11-2145

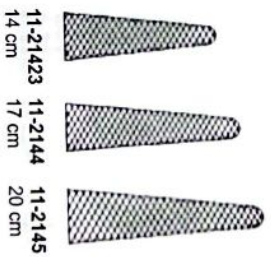

11-2143
14 cm

11-2144
17 cm

11-2145
20 cm



Mathieu
11-2146-11-2147



11-2146
14 cm

11-2147
17 cm

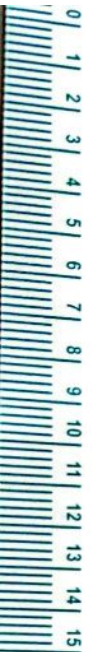

Needle Holders, Micro Needle Holders



Mathieu
11-2148-11-2150

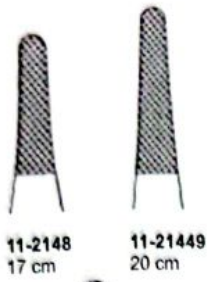

11-2148
17 cm

11-21449
20 cm



11-2150
23 cm



Arruga
11-2151-11-2152



11-2151
13.5 cm



11-2152
13.5 cm



Kalt
11-2153
13.5 cm



Kalt-arruga
11-2154
14 cm



Castroviejo-kalt
11-2155
14 cm



Boynton
11-2156
12 cm



Arruga
11-2157-11-2158
16 cm



11-2157



11-2158



Arruga
11-2159-11-2160
16 cm



11-2159



11-2160



Stevens
11-2161
13 cm, 15 cm



Barraquer
11-2162
14 cm



Needle Holders, Micro Needle Holders

Suture



11-2163
14.5 cm



11-2164
14.5 cm



Castroviejo
11-2165
14.5 cm



11-2166
14.5 cm



11-2167
14.5 cm



Jacobson
11-2168
18.5 cm, 21 cm



Jacobson
11-2169
18.5 cm, 21 cm



Castroviejo
11-2170
10 cm



Castroviejo
11-2171
10 cm



11-2172
16 cm



11-2173-11-2175

11-2173
Fig.1
23 cm

11-2174
Fig.2
23 cm

11-2175
Fig.3
19 cm



Castroviejo-barraquer
11-2176
12 cm



Castroviejo
11-2177
12 cm



Castroviejo
11-2178
12 cm

Reverdin Needles, Ligature Needles

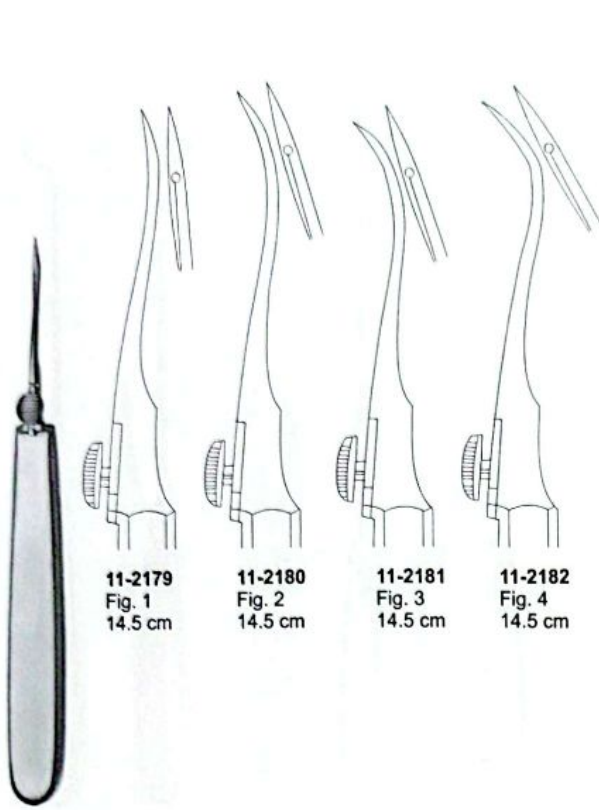

11-2179
Fig. 1
14.5 cm

11-2180
Fig. 2
14.5 cm

11-2181
Fig. 3
14.5 cm

11-2182
Fig. 4
14.5 cm

Reverdin
11-2179-11-2182



11-2183
Fig. 1
20 cm

11-2184
Fig. 2
20 cm

11-2185
Fig. 3
20 cm

11-2186
Fig. 4
20 cm

11-2187
Fig. 1
23 cm

11-2188
Fig. 2
23 cm

11-2189
Fig. 3
23 cm

11-2190
Fig. 4
23 cm

Reverdin
11-2183-11-2186

Reverdin
11-2187-11-2190



Deschamps
11-2191
20 cm

Deschamps
11-2192
20 cm

Deschamps
11-2193
20 cm

Deschamps
11-2194
20 cm

Deschamps
11-2195
24 cm

Deschamps
11-2196
24 cm



Ligature Needles

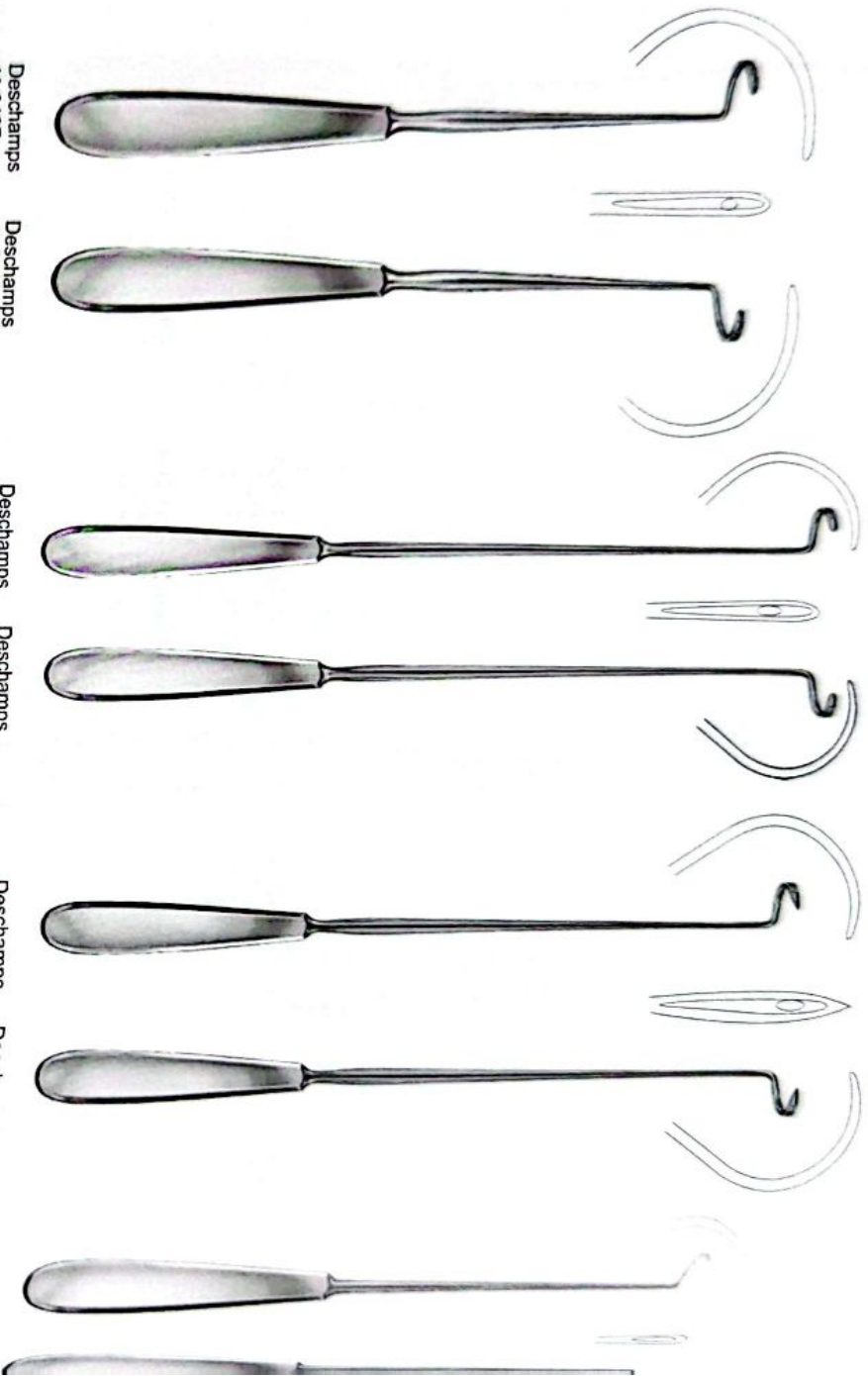

Deschamps
11-2197
20 cm

Deschamps
11-2198
20 cm

Deschamps
11-2199
27 cm

Deschamps
11-2200
27 cm

Deschamps
11-2201
27 cm

Deschamps
11-2202
27 cm

Deschamps
11-2203
21 cm

Deschamps
11-2204
21 cm



11-2206
Fig. 1

11-2207
Fig. 2

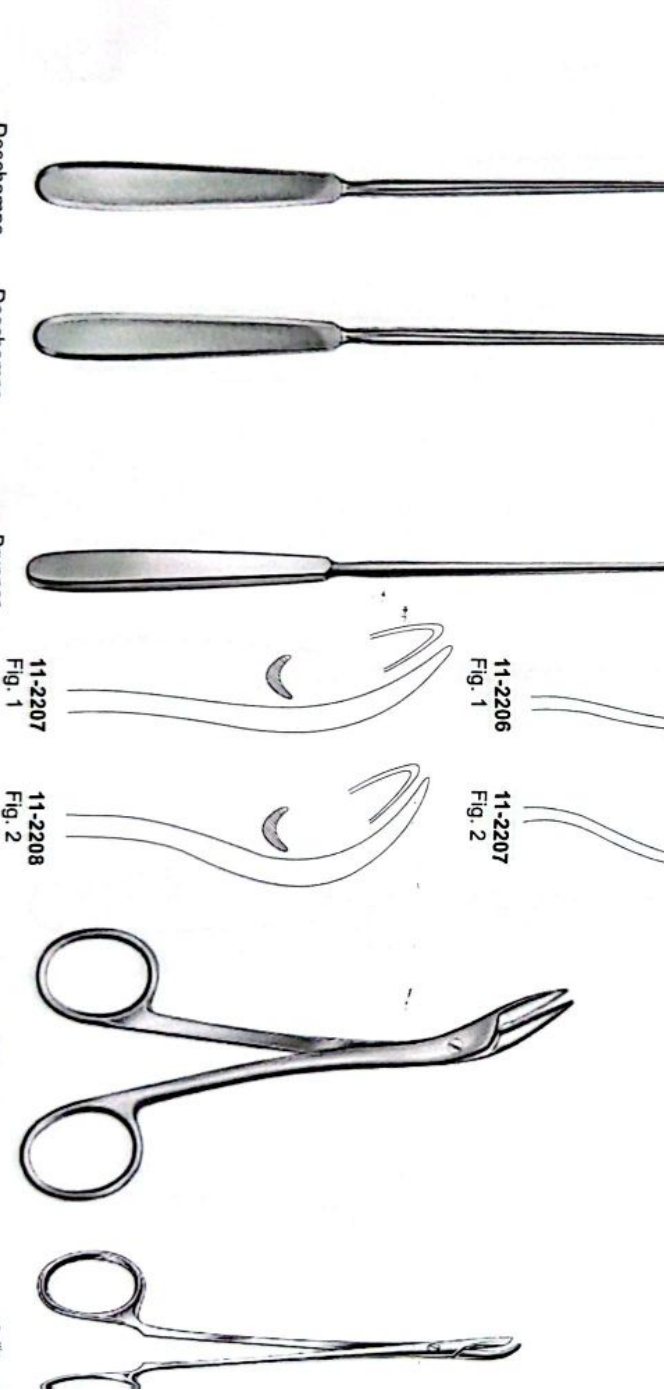

Deschamps
11-2205
28 cm

Deschamps
11-2206
28 cm

Brunner
11-2207-11-2208
30 cm

11-2207
Fig. 1

11-2208
Fig. 2

Richter
11-2209
14 cm

Collin
11-2210
14 cm

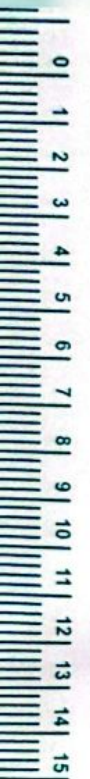

Ligature Needles

Suture

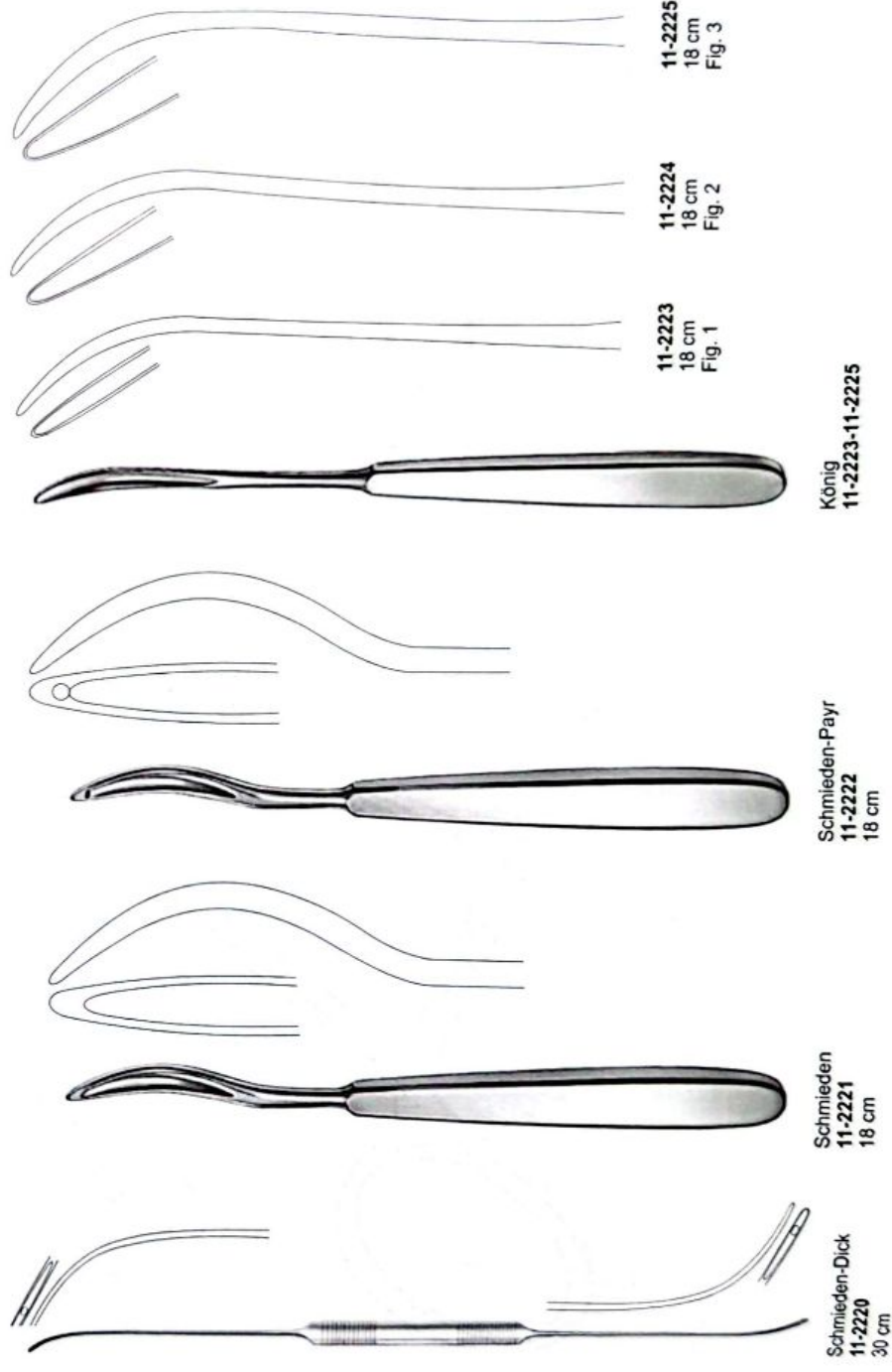
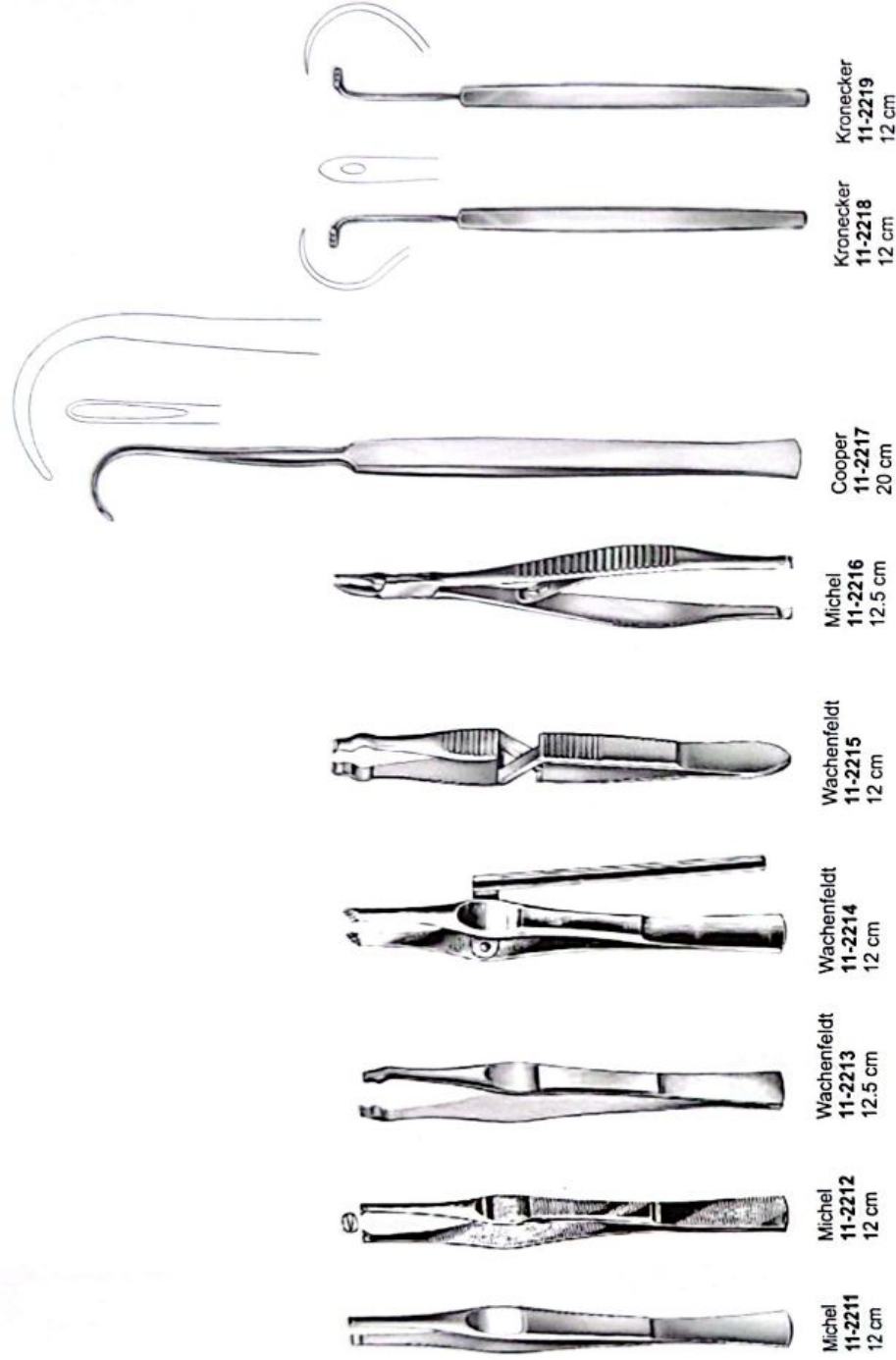

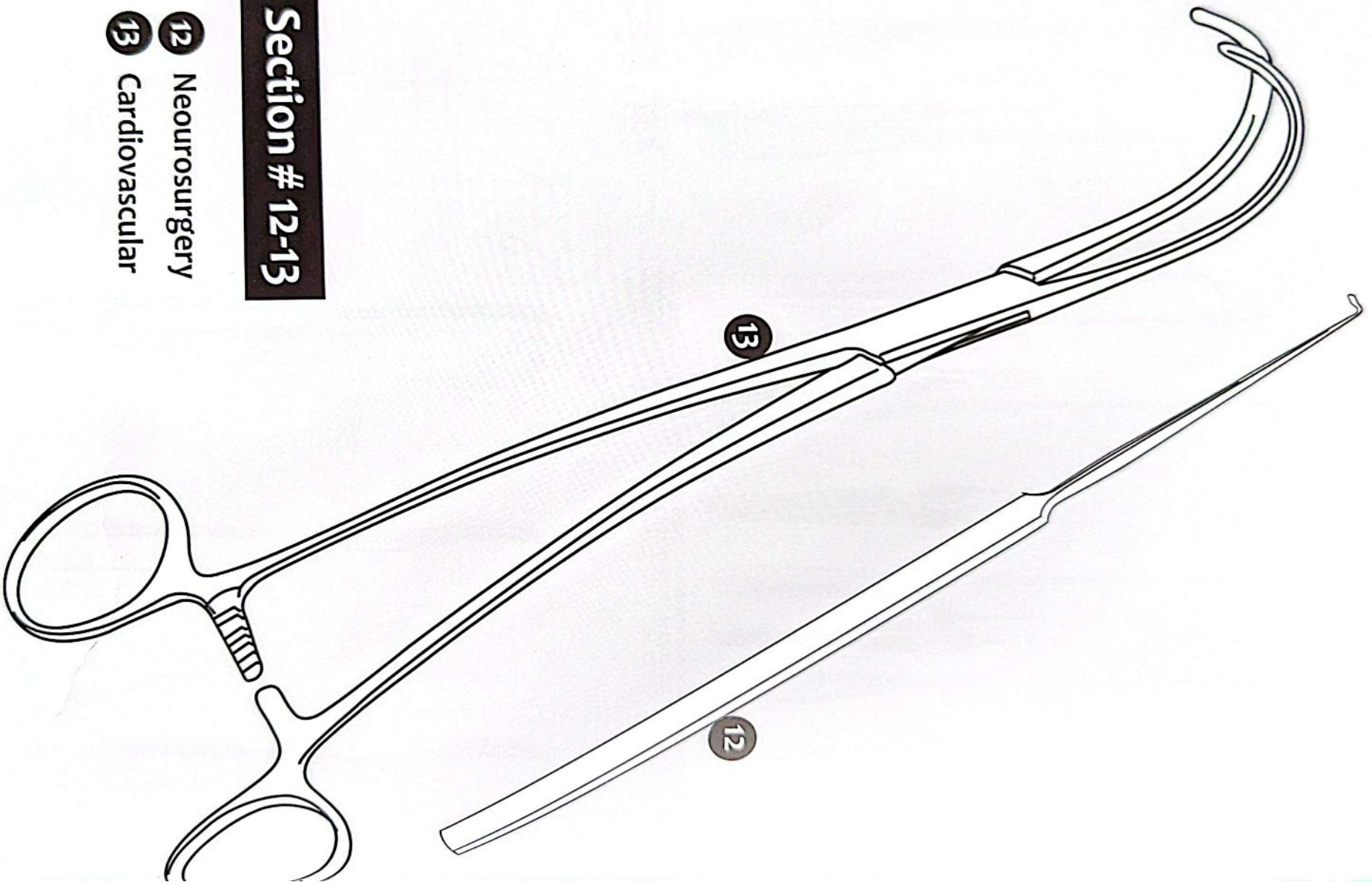

Section # 12-13

- 12 Neurosurgery
- 13 Cardiovascular

Dura Dissectors & Hooks



12-2300
Frazier
24 cm / 9 4/8"
Ø 3,3 mm



12-2301-12-2308
Frazier

- 12-2301 19,5 cm / 7 5/8" Ø 2,0 mm
- 12-2302 19,5 cm / 7 5/8" Ø 2,3 mm
- 12-2303 19,5 cm / 7 5/8" Ø 2,7 mm
- 12-2304 19,5 cm / 7 5/8" Ø 3,0 mm
- 12-2305 19,5 cm / 7 5/8" Ø 3,3 mm
- 12-2306 19,5 cm / 7 5/8" Ø 3,6 mm
- 12-2307 19,5 cm / 7 5/8" Ø 4,0 mm
- 12-2308 19,5 cm / 7 5/8" Ø 5,0 mm



12-2309
HOEN
15 cm / 5 7/8



12-2310
HOEN
15 cm / 5 7/8



12-2311
Sachs
20,5 cm / 8 1/8"



12-2312
Milligan
21,5 cm / 8 4/8"



12-2313
SACHS
21 cm / 8 1/4"

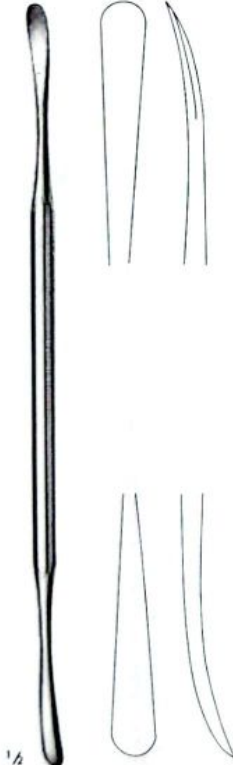

12-2314
22 cm / 8 5/8"



12-2315
WOODSON
25 cm / 9 7/8



12-2316
Davis
21,5 cm / 8 4/8"



12-2317
Davis
24,5 cm / 9 5/8"



12-2318
21 cm / 8 1/4"

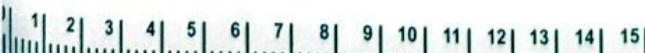

Dura Dissectors ,Nerve Hooks ,
Nerve Root Retractors

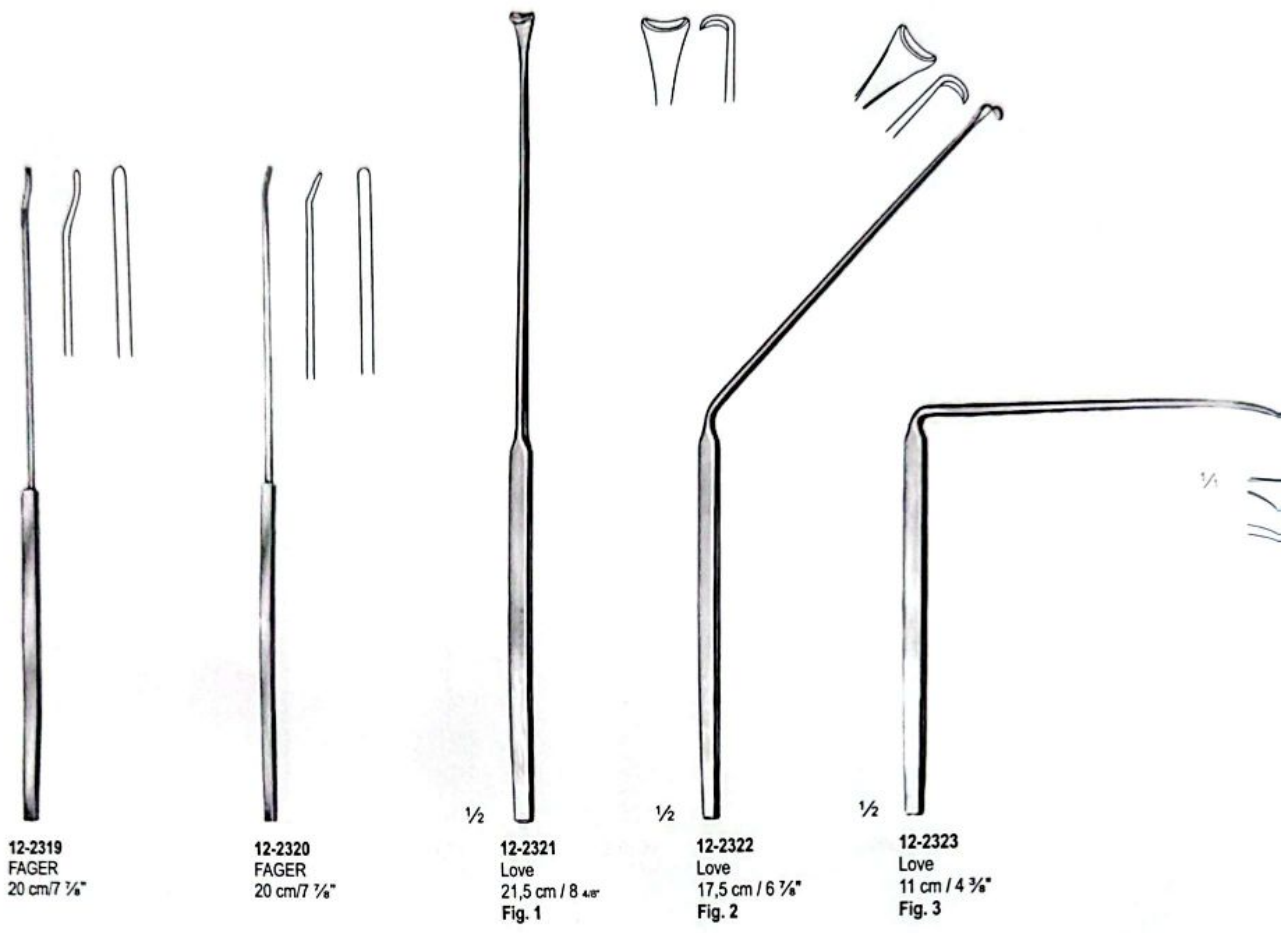

12-2319
FAGER
20 cm / 7 7/8"

12-2320
FAGER
20 cm / 7 7/8"

1/2
12-2321
Love
21,5 cm / 8 4/8"
Fig. 1

1/2
12-2322
Love
17,5 cm / 6 7/8"
Fig. 2

1/2
12-2323
Love
11 cm / 4 3/8"
Fig. 3



12-2324
WOODSON
17 cm / 6 3/4"

12-2325
HORSLEY
20 cm / 7 7/8"

12-2326
SACHS
21 cm / 8 1/4"

12-2327
16 cm / 6 1/4"

1/2 1/4
12-2328
Toennis
24 cm / 9 4/8"



Nerve Hooks, Wire Saws



12-2329
Groningen
26.5 cm / 10 3/8"



12-2330
Groningen
26.5 cm / 10 3/8"

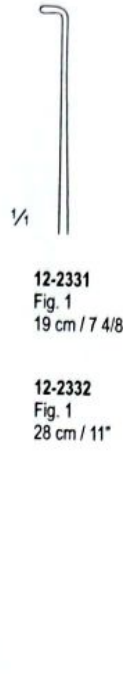

12-2331
Fig. 1
19 cm / 7 4/8"

12-2332
Fig. 1
28 cm / 11"

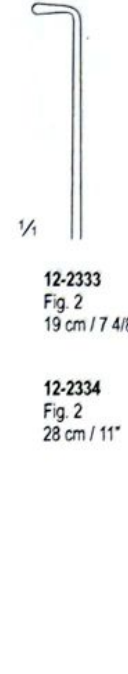

12-2333
Fig. 2
19 cm / 7 4/8"

12-2334
Fig. 2
28 cm / 11"

12-2331-12-2332
Cushing

12-2333-12-2334
Cushing

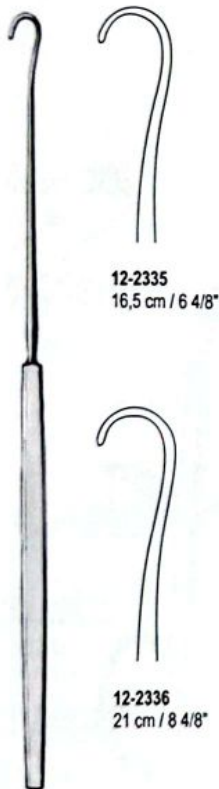

12-2335
16.5 cm / 6 4/8"



12-2336
21 cm / 8 4/8"

12-2335-12-2336
Smithwick

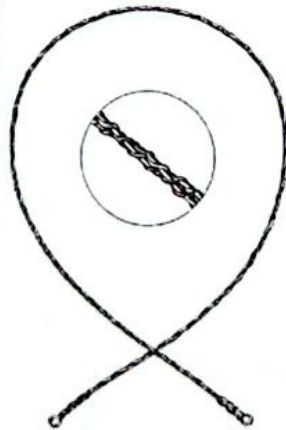

12-2337-12-2341
Gigli Wire Saw

12-2337
30 cm / 11 6/8"

12-2338
40 cm / 15 6/8"

12-2339
50 cm / 19 5/8"

12-2340
60 cm / 23 5/8"

12-2341
70 cm / 27 4/8"

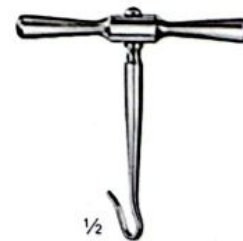

12-2342
Gigli



12-2343
De Martel
33 cm / 13"



Cranial Rongeurs, Applying Forceps,
Lamina Spreaders



12-2344
Dahlgren
19,5 cm / 7 5/8"



12-2345
De Vibiss
21 cm / 8 2/8"



12-2346
McKenzie
18,5 cm / 7 2/8"

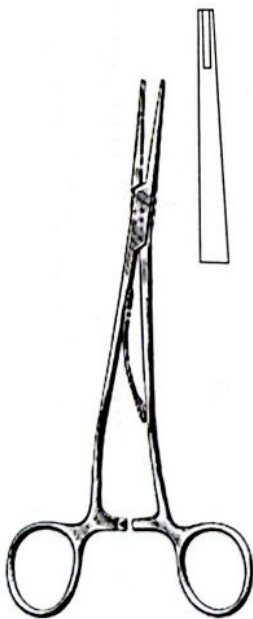

McKENZIE
12-2347 15cm/5
12-2348 19cm/7 1/2"



12-2349
Raney
15,5 cm / 6"



12-2350
Cloward
16 cm / 6 2/8"



Lamina Spreaders, Laminectomy Punches



12-2351
Inge
16 cm / 6 2/8"



12-2352
De Vilbiss
21 cm / 8 2/8"

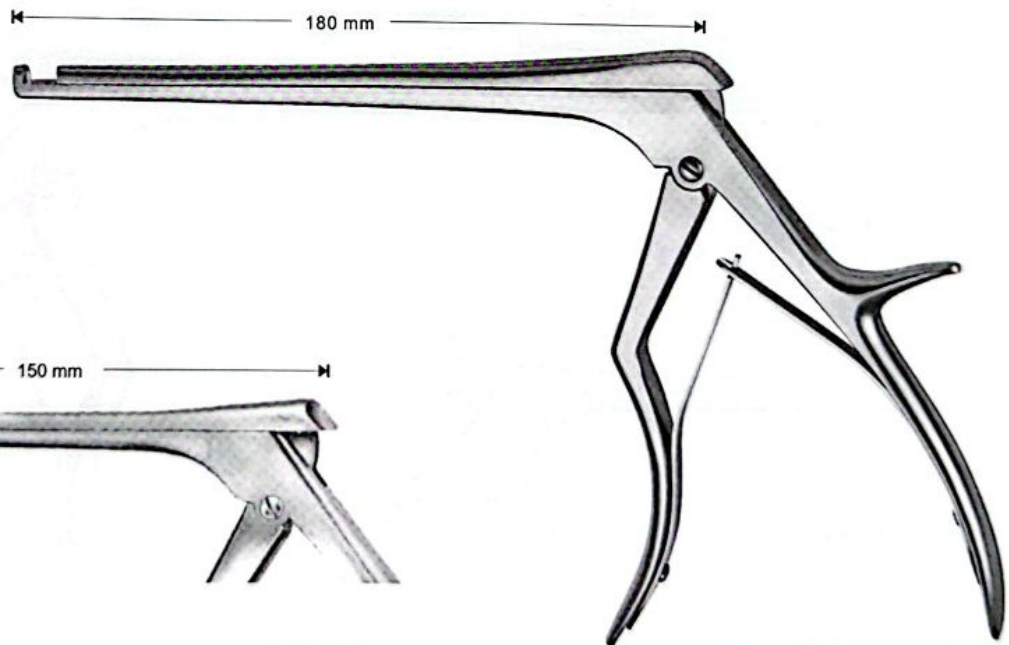

12-2353
3mm, bite

12-2354
5mm, bite

12-2355
3mm, bite

12-2356
5mm, bite

12-2355-2356
Colclough

12-2353-2354
Colclough

Laminectomy Punches

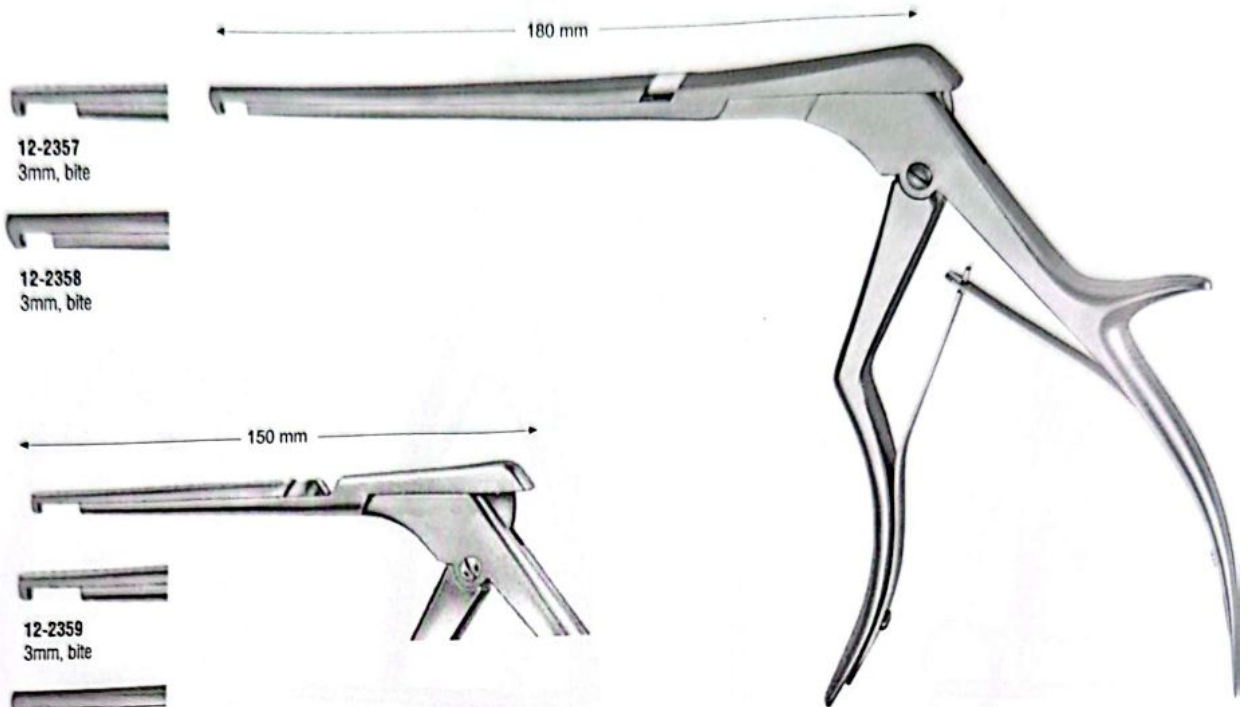

12-2357
3mm, bite

12-2358
3mm, bite

12-2359
3mm, bite

12-2360
3mm, bite

12-2359-2360
Colclough

12-2357-2358
Colclough

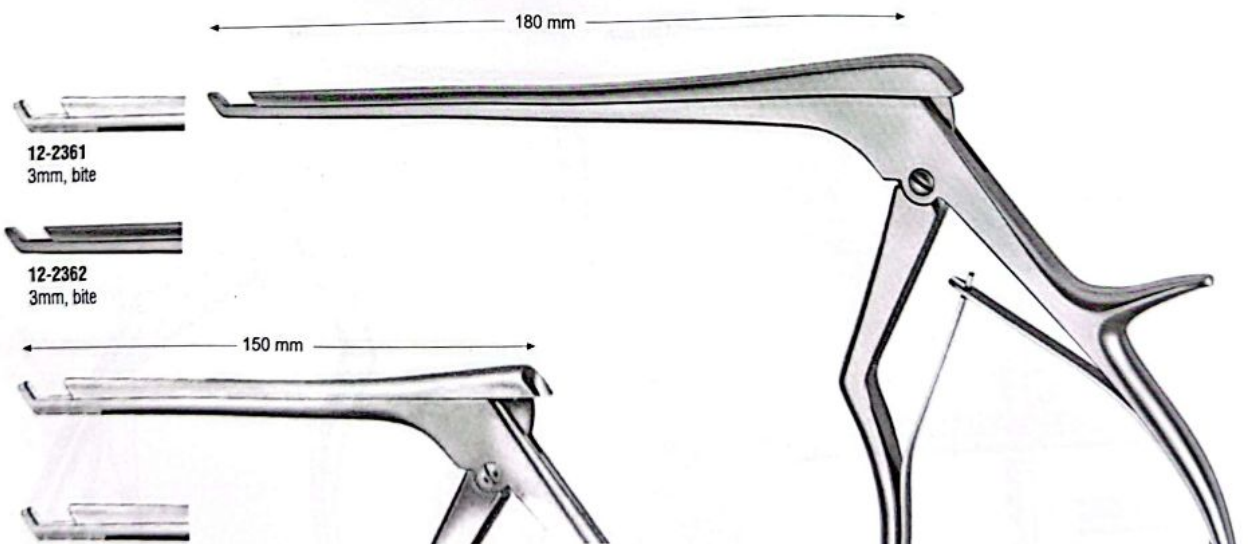

12-2361
3mm, bite

12-2362
3mm, bite

12-2363
3mm, bite

12-2364
3mm, bite

12-2363-2364
Colclough (Richter)

12-2361-2362
Colclough (Richter)



Laminectomy Punches

upwards cutting
 12-2365 shaft length 180mm
 12-2366 shaft length 230mm

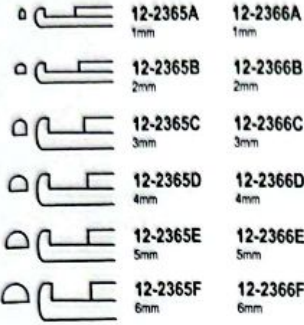

12-2365-2368
 Ferris-Smith Kerrison

40° upwards cutting
 12-2367 shaft length 180mm
 12-2368 shaft length 230mm

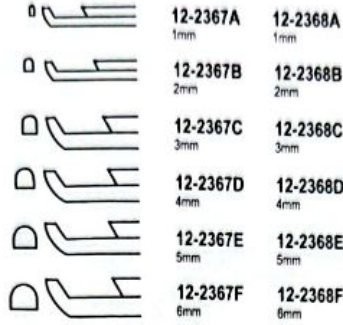

upwards cutting
 12-2369 shaft length 180mm
 12-2370 shaft length 230mm

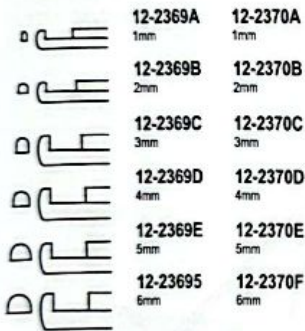

upwards cutting

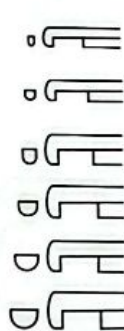

upwards cutting
 12-2371 shaft length 180mm
 12-2372 shaft length 230mm



40° upwards cutting



upwards cutting
 12-2373 shaft length 180mm
 12-2374 shaft length 230mm



12-2369-2374
 Ferris-Smith Kerrison

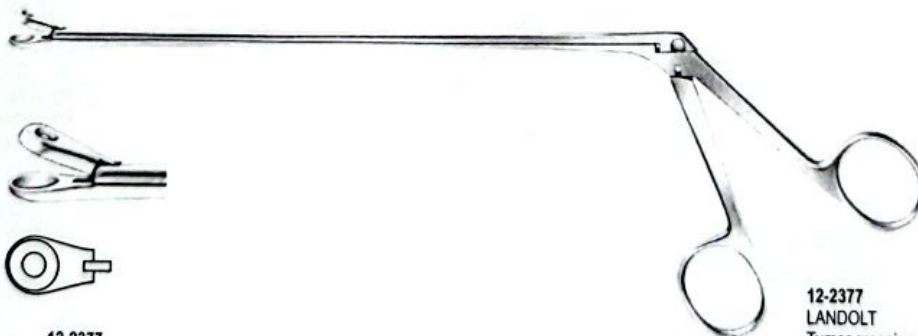

12-2375-12-2376
 YASARGIL

12-2377
 Ø 9.0 mm

12-2377
 LANDOLT
 Tumor grasping forceps,
 blunt

Laminectomy Punches, Rongeurs

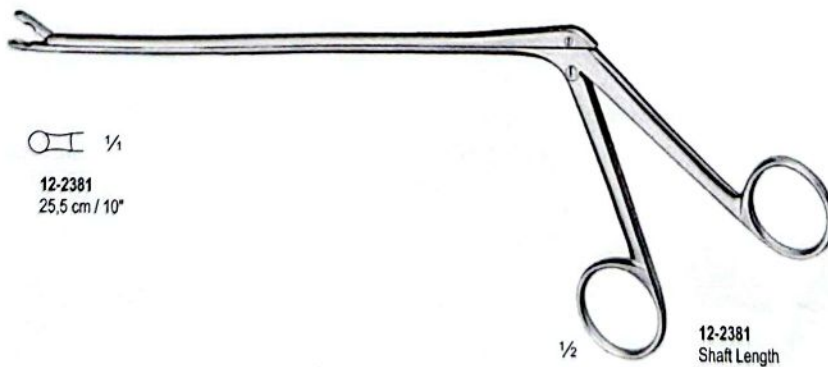
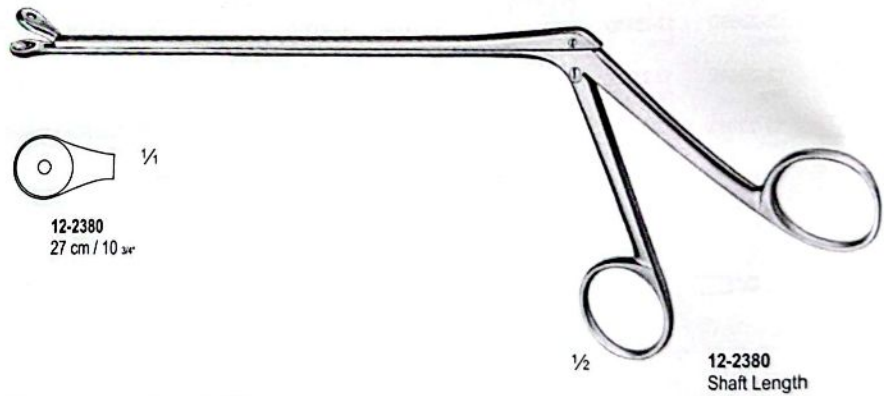
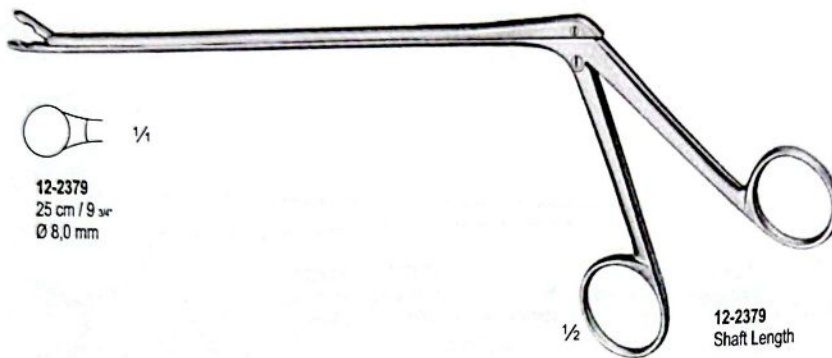
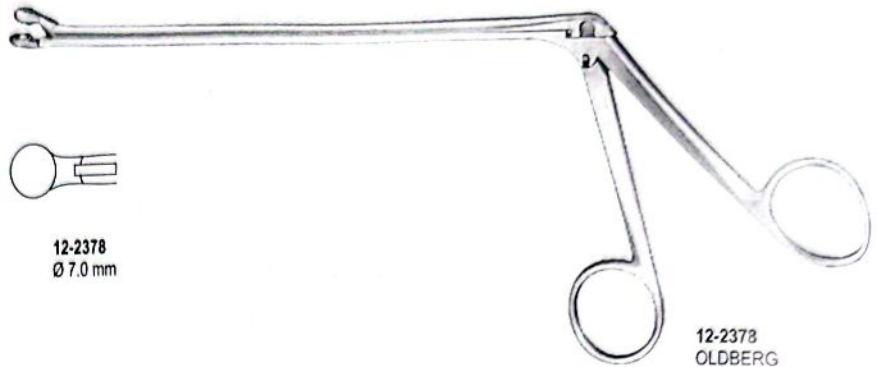

Rongeurs



12-2382- Shaft 12.5 cm
12-2382- Shaft 14 cm
12-2382- Shaft 16 cm
12-2382- Shaft 18.5 cm
2 x 10mm



12-2385- Shaft 12.5 cm
12-2385- Shaft 14 cm
12-2385- Shaft 16 cm
12-2385- Shaft 18.5 cm
3 x 10mm



12-2388- Shaft 12.5 cm
12-2388- Shaft 14 cm
12-2388- Shaft 16 cm
12-2388- Shaft 18.5 cm
4 x 10mm



12-2391- Shaft 12.5 cm
12-2391- Shaft 14 cm
12-2391- Shaft 16 cm
12-2391- Shaft 18.5 cm
5 x 10mm



12-2383- Shaft 12.5 cm
12-2383- Shaft 14 cm
12-2383- Shaft 16 cm
12-2383- Shaft 18.5 cm
2 x 10mm

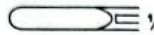

12-2386- Shaft 12.5 cm
12-2386- Shaft 14 cm
12-2386- Shaft 16 cm
12-2386- Shaft 18.5 cm
3 x 10mm



12-2389- Shaft 12.5 cm
12-2389- Shaft 14 cm
12-2389- Shaft 16 cm
12-2389- Shaft 18.5 cm
4 x 10mm



12-2392- Shaft 12.5 cm
12-2392- Shaft 14 cm
12-2392- Shaft 16 cm
12-2392- Shaft 18.5 cm
5 x 10mm



12-2384- Shaft 12.5 cm
12-2384- Shaft 14 cm
12-2384- Shaft 16 cm
12-2384- Shaft 18.5 cm
2 x 10mm



12-2387- Shaft 12.5 cm
12-2387- Shaft 14 cm
12-2387- Shaft 16 cm
12-2387- Shaft 18.5 cm
3 x 10mm



12-2390- Shaft 12.5 cm
12-2390- Shaft 14 cm
12-2390- Shaft 16 cm
12-2390- Shaft 18.5 cm
4 x 10mm



12-2393- Shaft 12.5 cm
12-2393- Shaft 14 cm
12-2393- Shaft 16 cm
12-2393- Shaft 18.5 cm
5 x 10mm

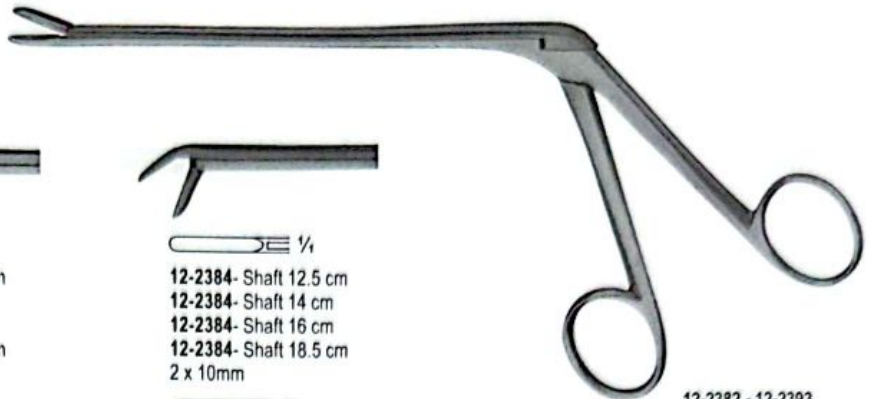

12-2382 - 12-2393
CASPAR

12-2382 - 2384	
2 mm	
12-2385 - 2387	
3 mm	
12-2388 - 2390	
4 mm	
12-2391 - 2393	
5 mm	



CUSHING
12-2394- Shaft 12 cm
12-2394- Shaft 15 cm
12-2394- Shaft 16 cm
12-2394- Shaft 18 cm
2 x 10mm



LOVE-GRUENWALD
12-2397- Shaft 12 cm
12-2397- Shaft 15 cm
12-2397- Shaft 16 cm
12-2397- Shaft 18 cm
3 x 10mm



SPURING
12-2400- Shaft 12 cm
12-2400- Shaft 15 cm
12-2400- Shaft 16 cm
12-2400- Shaft 18 cm
4 x 10mm



CUSHING
12-2395- Shaft 12 cm
12-2395- Shaft 15 cm
12-2395- Shaft 16 cm
12-2395- Shaft 18 cm
2 x 10mm



LOVE-GRUENWALD
12-2398- Shaft 12 cm
12-2398- Shaft 15 cm
12-2398- Shaft 16 cm
12-2398- Shaft 18 cm
3 x 10mm



SPURING
12-2401- Shaft 12 cm
12-2401- Shaft 15 cm
12-2401- Shaft 16 cm
12-2401- Shaft 18 cm
4 x 10mm



CUSHING
12-2396- Shaft 12 cm
12-2396- Shaft 15 cm
12-2396- Shaft 16 cm
12-2396- Shaft 18 cm
2 x 10mm

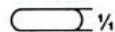

LOVE-GRUENWALD
12-2399- Shaft 12 cm
12-2399- Shaft 15 cm
12-2399- Shaft 16 cm
12-2399- Shaft 18 cm
3 x 10mm



SPURING
12-2402- Shaft 12 cm
12-2402- Shaft 15 cm
12-2402- Shaft 16 cm
12-2402- Shaft 18 cm
4 x 10mm

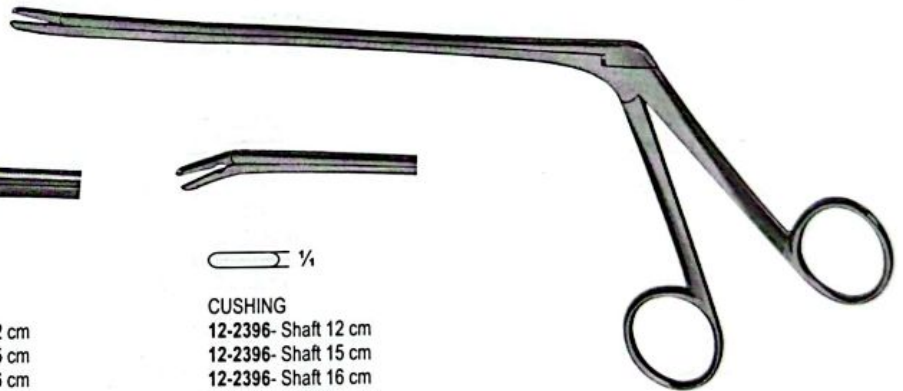

12-2394 - 12-2402
CASPAR



Rongeurs



12-2403 - 12-2417
CASPAR



12-2403- Shaft 12.5 cm
12-2403- Shaft 14 cm
12-2403- Shaft 16 cm
12-2403- Shaft 18.5 cm
2 x 12mm Size of Jaws



12-2406- Shaft 12.5 cm
12-2406- Shaft 14 cm
12-2406- Shaft 16 cm
12-2406- Shaft 18.5 cm
3 x 12mm Size of Jaws



12-2409- Shaft 12.5 cm
12-2403- Shaft 14 cm
12-2403- Shaft 16 cm
12-2403- Shaft 18.5 cm
4 x 12mm Size of Jaws



12-2412- Shaft 12.5 cm
12-2412- Shaft 14 cm
12-2412- Shaft 16 cm
12-2412- Shaft 18.5 cm
5 x 12mm Size of Jaws



12-2415- Shaft 12.5 cm
12-2415- Shaft 14 cm
12-2415- Shaft 16 cm
12-2415- Shaft 18.5 cm
6 x 12mm Size of Jaws



12-2404- Shaft 12.5 cm
12-2404- Shaft 14 cm
12-2404- Shaft 16 cm
12-2404- Shaft 18.5 cm
2 x 12mm Size of Jaws



12-2407- Shaft 12.5 cm
12-2407- Shaft 14 cm
12-2407- Shaft 16 cm
12-2407- Shaft 18.5 cm
3 x 12mm Size of Jaws



12-2410- Shaft 12.5 cm
12-2410- Shaft 14 cm
12-2410- Shaft 16 cm
12-2410- Shaft 18.5 cm
4 x 12mm Size of Jaws



12-2413- Shaft 12.5 cm
12-2413- Shaft 14 cm
12-2413- Shaft 16 cm
12-2413- Shaft 18.5 cm
5 x 12mm Size of Jaws



12-2416- Shaft 12.5 cm
12-2416- Shaft 14 cm
12-2416- Shaft 16 cm
12-2416- Shaft 18.5 cm
6 x 12mm Size of Jaws



12-2405- Shaft 12.5 cm
12-2405- Shaft 14 cm
12-2405- Shaft 16 cm
12-2405- Shaft 18.5 cm
2 x 12mm Size of Jaws

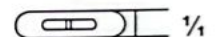

12-2408- Shaft 12.5 cm
12-2408- Shaft 14 cm
12-2408- Shaft 16 cm
12-2408- Shaft 18.5 cm
3 x 12mm Size of Jaws



12-2411- Shaft 12.5 cm
12-2411- Shaft 14 cm
12-2411- Shaft 16 cm
12-2411- Shaft 18.5 cm
4 x 12mm Size of Jaws



12-2414- Shaft 12.5 cm
12-2414- Shaft 14 cm
12-2414- Shaft 16 cm
12-2414- Shaft 18.5 cm
5 x 12mm Size of Jaws



12-2417- Shaft 12.5 cm
12-2417- Shaft 14 cm
12-2417- Shaft 16 cm
12-2417- Shaft 18.5 cm
6 x 12mm Size of Jaws



Rib Shears, Sternum Chisel



Bone Shears
13-2400
23 cm



13-2401
23 cm



Gluck
13-2402
21 cm



Brunner
13-2403
32 cm



Giertz-Stille
13-2404
24.5 cm

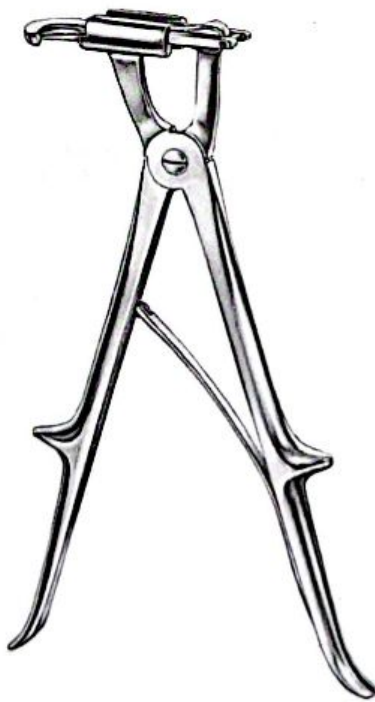

Sauerbruch
13-2405
26 cm



Bethune
13-2406
34.5 cm

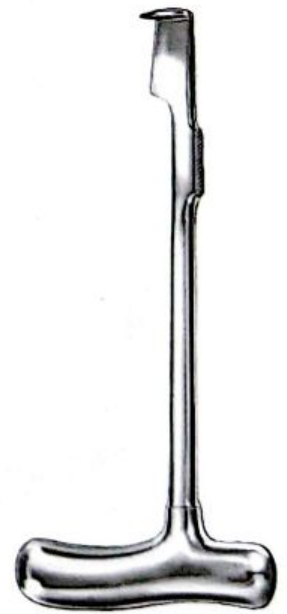

Lebsche
13-2407
24.5 cm



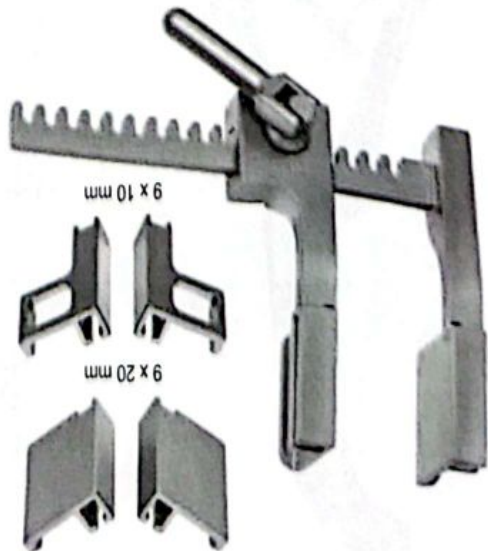

13-2408 for babies with 2 pairs of blades spreading (52 mm) (9x20) (9x10)

13-2410 for children lateral blades spreading (140 mm) (150 mm) (15x30) (21x44) Coolley

13-2412 Finochietto, Infant for babies lateral blades spreading (75 mm) (15x15)

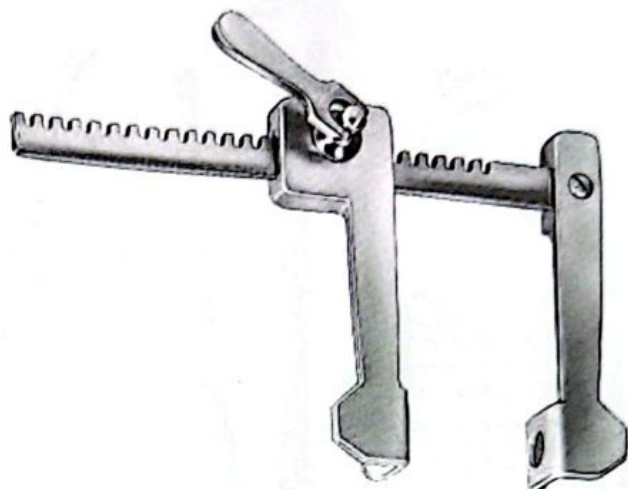

13-2411 for adults lateral blades spreading (200 mm) (35x50) Coolley



13-2413 for children lateral blades (31x31) (100 mm) spreading Finochietto, Baby



Rib Retractors, Sternal Retractors



13-2414 lateral blades spreading
Finochietto (40x45)(52x62)(85x65) (135 mm) (175 mm)



13-2415 with 2 pairs of blades spreading
Burford (47x62) + (65x62) (200 mm)
(47x62) + (65x62) (260 mm)

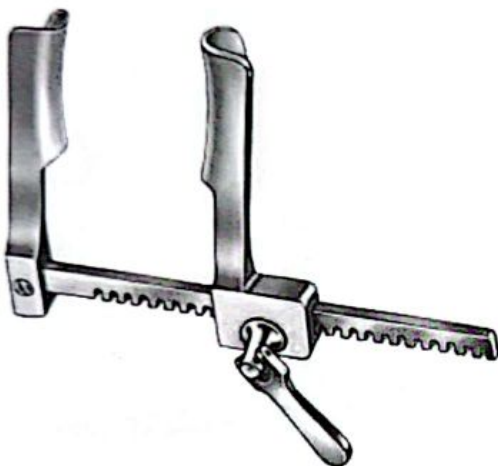

13-2416 for babies lateral blades spreading
Castañeda (10,5x32) (65 mm)



13-2417 for infants lateral blades spreading
Castañeda (12x45) (70 mm)



13-2418 for infants lateral blades spreading
Castañeda (15x60) (120 mm)



13-2419 lateral blades spreading
Finochietto (modif.) (14x15) (120 mm)



Rib Retractors,



13-2420 lateral blades spreading
Haigh (30x30) (120 mm)



13-2421 for children 4 movable blades spreading
Morse-Favaloro (17x22) (160 mm)

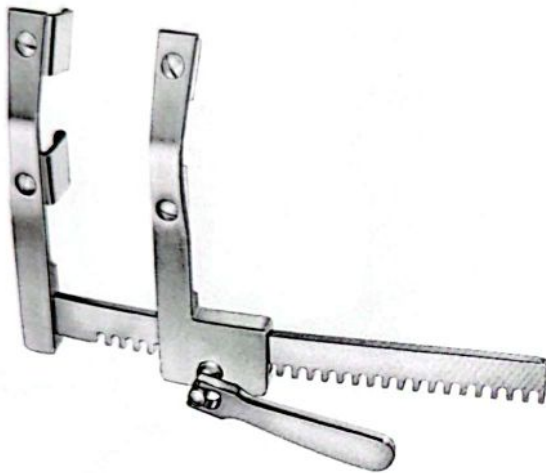

13-2422 for adults 4 movable blades spreading
Morse (22x27) (200 mm)



13-2423 lateral blades spreading
Tuffier (45x45) (160 mm)

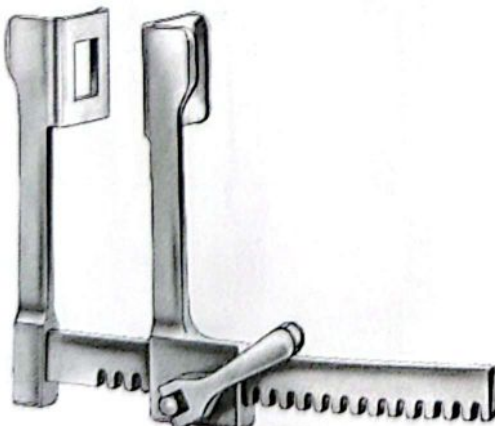

13-2424 lateral blades spreading
Finochietto, Baby (14x15) (75 mm)



13-2425 lateral blades spreading
Finochietto (30x45) (46x62) (150 mm) (190 mm) (80x65)



Rib Retractors, Thoracic Retractor



13-2426 with 3 pairs of blades
De Bakey (30x30) (40x40) spreading
(150 mm)

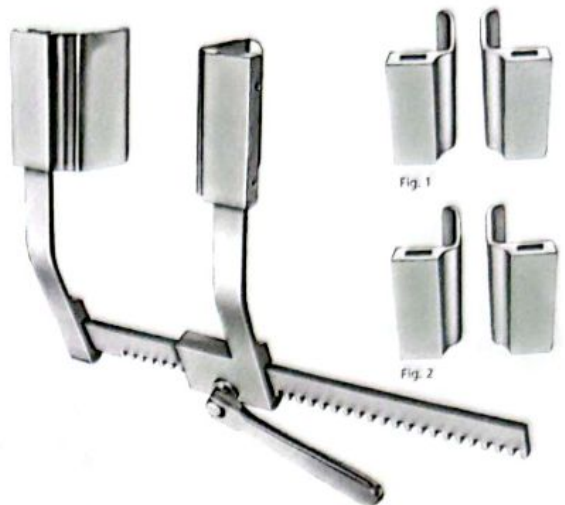

13-2427 with 3 pairs of blades
De Bakey (60x60) (50x80) (40x100) spreading
(200 mm)

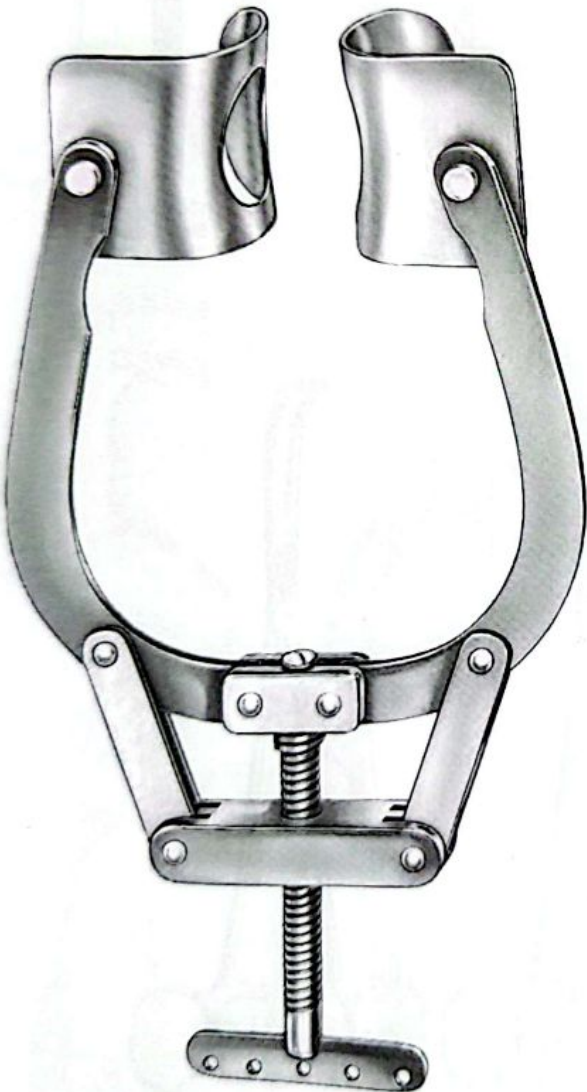

13-2428 with 1 pair of blades each
(Mercedes Retractor)

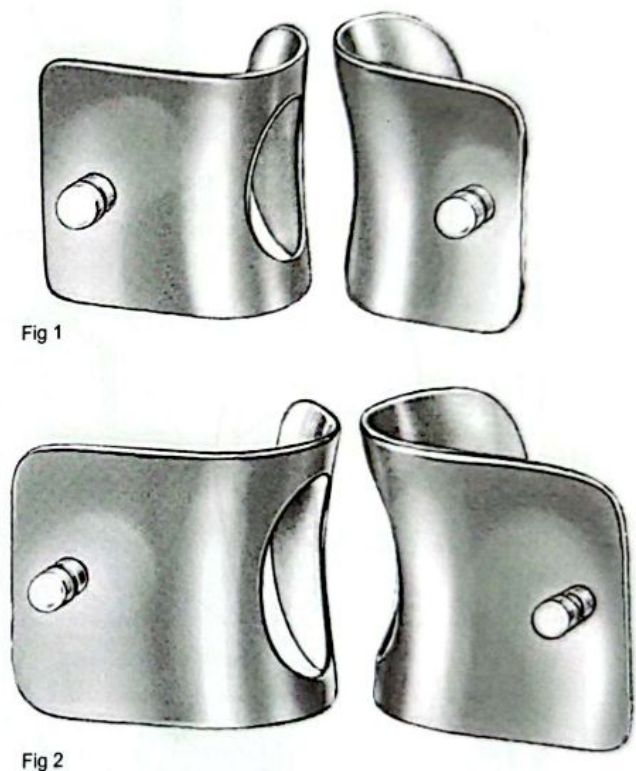

Lateral Blades Pair
Fig 1 (48x68) (70x75)
Fig 2



Rib Contractors, Lung Spatulas,
Bronchus Clamps



13-2429
Sellers
20 cm / 7 7/8"

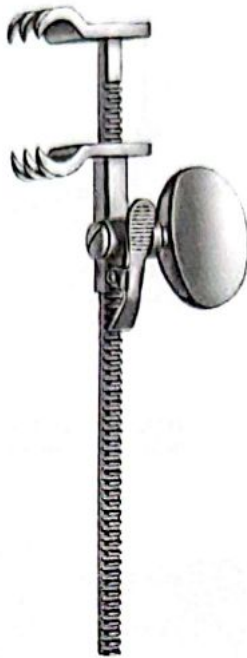

13-2430
Bailey-Baby
15,5 cm / 6 1/8"



13-2431
Bailey
20 cm / 7 7/8"



13-2432
Bailey-Gibbon
20 cm / 7 7/8"



13-2433
Allison
29.5 cm



13-2434

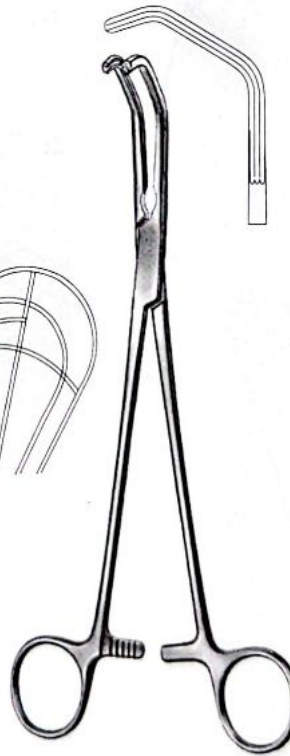
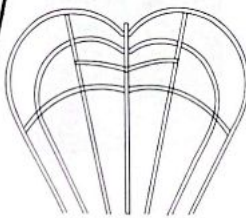

13-2435
Price-Thomas
22 cm / 8 5/8"



13-2436
Price-Thomas
22 cm / 8 5/8"

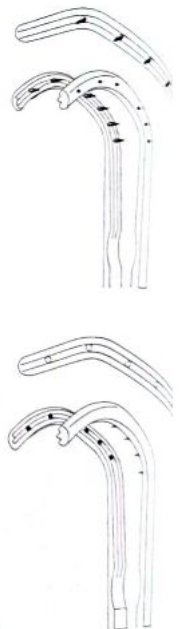

Bronchus Clamps, Lung Grasping Forceps, Bulldog Clamps



13-2437
Semb

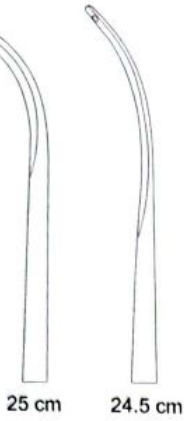

25 cm 24.5 cm

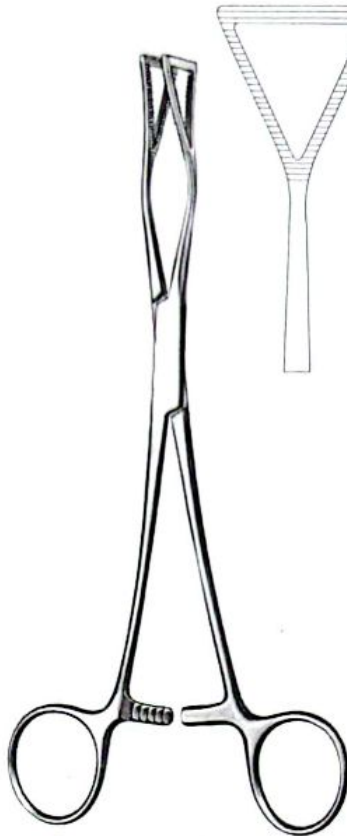

13-2438
Lovelace
20,5 cm / 8 1/8"



13-2439
Lovelace
19 cm / 7 4/8"



13-2440
De Bakey-Satinsky
7 cm / 2 6/8"



13-2441
De Bakey-Satinsky
9 cm / 3 4/8"

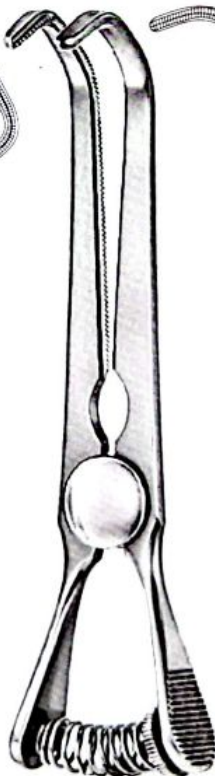

13-2442
De Bakey-Satinsky
10 cm / 3 7/8"



13-2443
Glover
6,5 cm / 2 4/8"



13-2444
Santulli
7 cm / 2 6/8"



Bronchus Clamps, Lung Grasping Forceps, Bulldog Clamps, Aortic Clamps



13-2445
Gregory, soft
Carotid clamp



11 cm



11 cm



13-2446
Gregory
Carotid clamp



13-2447
De Bakey-Rankin
16 cm

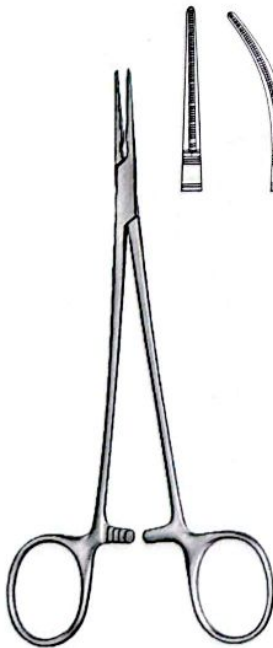

13-2448
De Bakey-Mosquito
15 cm



13-2449
Ochsner
22 cm / 8 5/8"

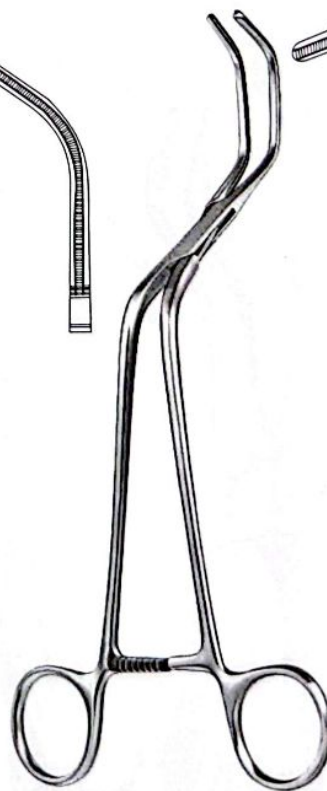
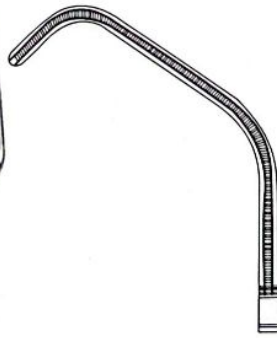

13-2450
Diethrich
22 cm / 8 5/8"



Multi purpose Vascular Clamps,
Peripheral Vascular Clamps



13-2451-13-2460
Dardik



13-2451
15 cm / 5 7/8"



13-2452
15,5 cm / 6 1/8"
15°



13-2453
15,5 cm / 6 1/8"
30°



13-2454
15 cm / 5 7/8"
45°



13-2455
13,5 cm / 5 3/8"
90°



13-2456
17 cm / 6 5/8"



13-2457
16,5 cm / 6 4/8"
15°



13-2458
16,5 cm / 6 4/8"
30°



13-2459
17 cm / 6 5/8"
45°



13-2460
13,5 cm / 5 3/8"
90°



13-2461
Dale
18 cm / 7 1/8"

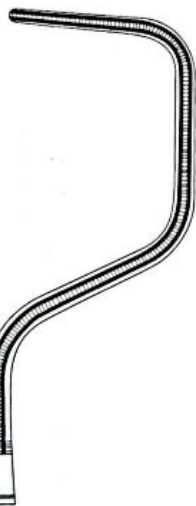

13-2462
17,5 cm / 6 7/8"

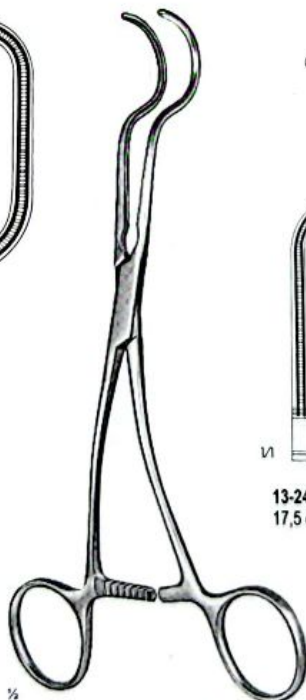

13-2462-13-2464
Dale



13-2463
18 cm / 7 1/8"



13-2464
18,5 cm / 7 2/8"



Profunda Clamps, Carotid Shunt Clamps

Cardiovascular Surgery

13-2469
David
18.5 cm



13-2468
David
17.5 cm

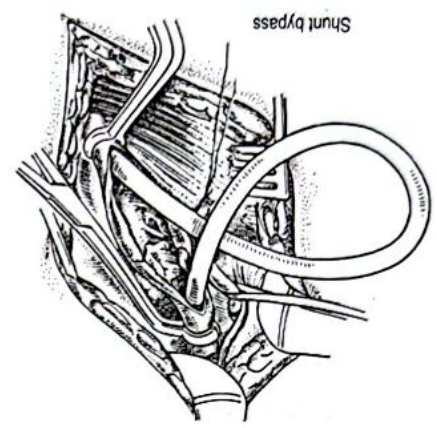
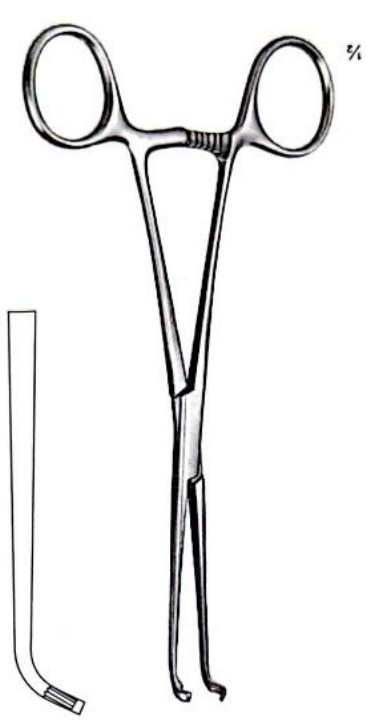

Shunt bypass

13-2465-13-2467
Gregory

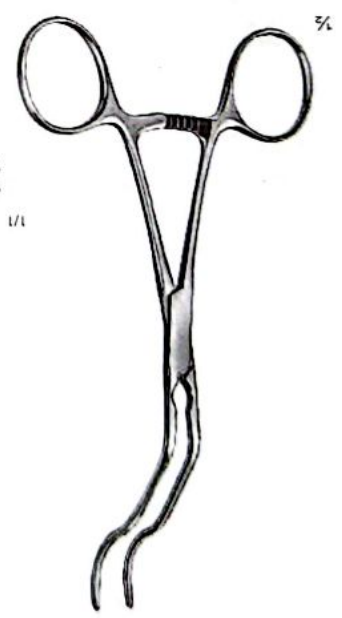

13-2465
13.5 cm / 5 1/2"

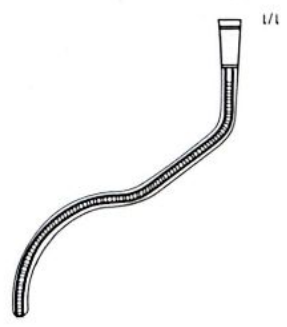

13-2466
16 cm / 6 2/8"

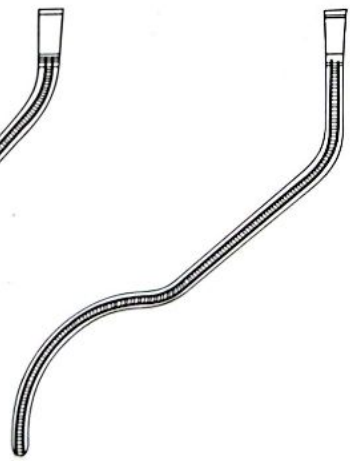

13-2467
18 cm / 7 1/8"



Aortic Clamps, Vascular Forceps



13-2470
De Bakay
30 cm



13-2471-13-2474
De Bakay
2,7 mm

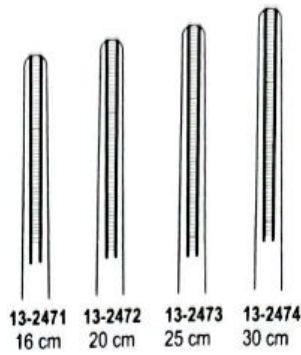

13-2475-13-2477
De Bakay
1,5 mm



13-2478-13-2481
De Bakay
2,0 mm



13-2482-13-2485
De Bakay
2,0 mm



13-2486-13-2489
De Bakay
3,5 mm



Bulldog Clamps, Coarctation Clamps



13-2498
Applying Forceps for
Bulldog clamps (24 cm)

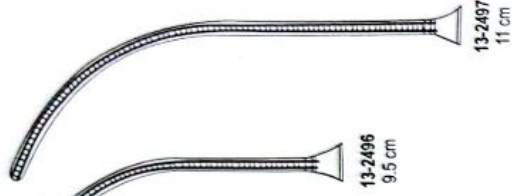

13-2497
11 cm

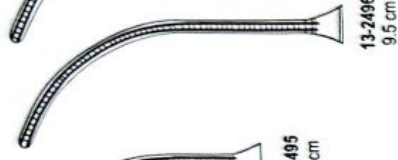

13-2496
9.5 cm

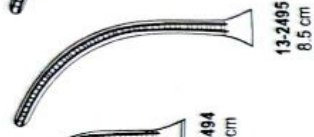

13-2495
8.5 cm



13-2494
7.5 cm



13-2494-13-2497
De Bakay



13-2493
12 cm



13-2492
10 cm



13-2491
8.5 cm



13-2490
7.5 cm



13-2490-13-2493
De Bakay

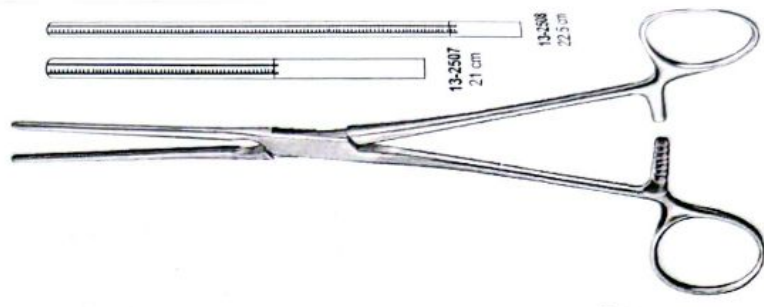

13-2507-13-2508
Polts

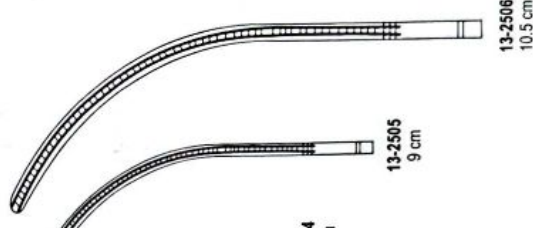

13-2506
10.5 cm



13-2505
9 cm



13-2504
7.5 cm



13-2503
6.5 cm

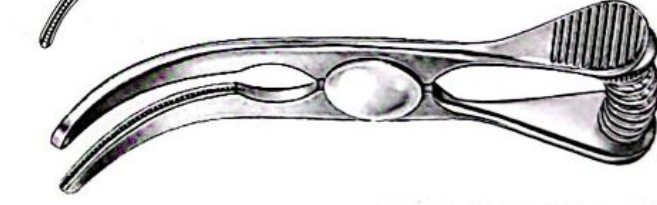

13-2503-13-2506
Glover



13-2502
11 cm



13-2501
9.5 cm



13-2500
8 cm



13-2499
7 cm



13-2499
Glover



Coarctation Clamps, Anastomosis Clamps, Ligature Forceps, Peripheral Vascular Clamps

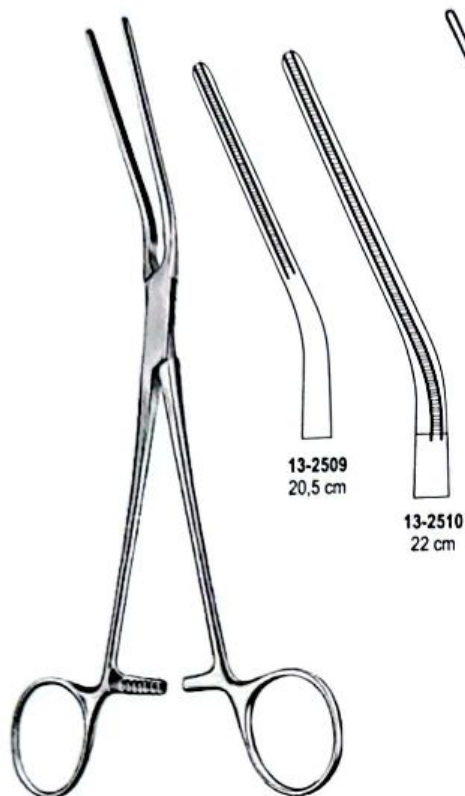

13-2509-13-2510
Potts

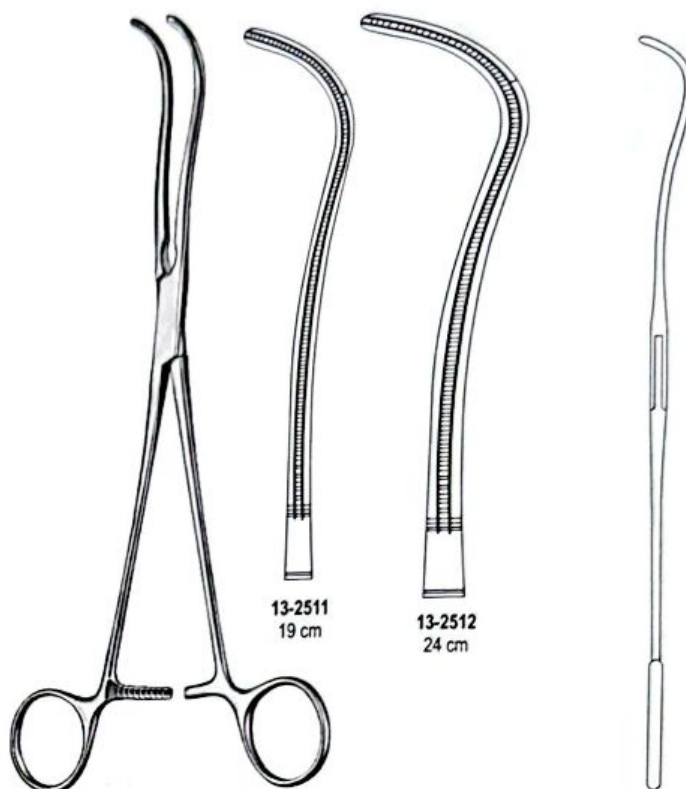

13-2511-13-2512
De Bakey
Dissecting and Ligature Forceps

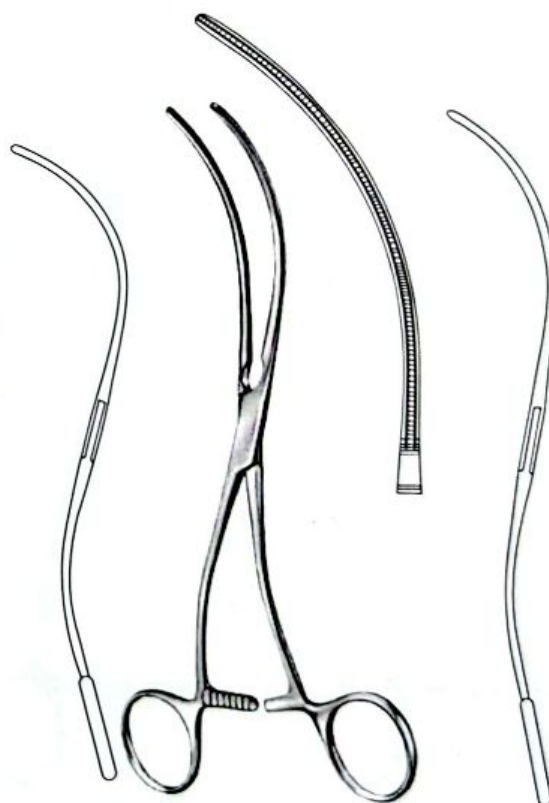
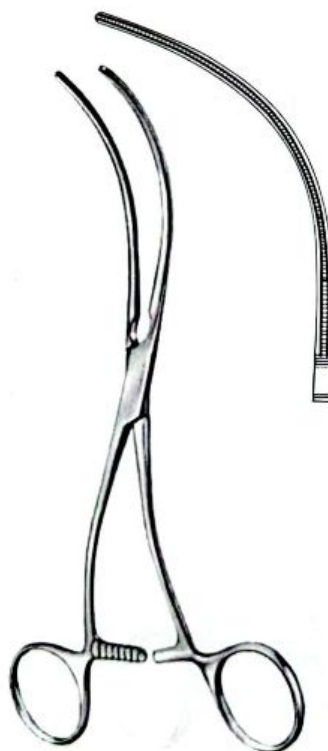

Peripheral Vascular Clamps, Multi purpose Vascular Clamps

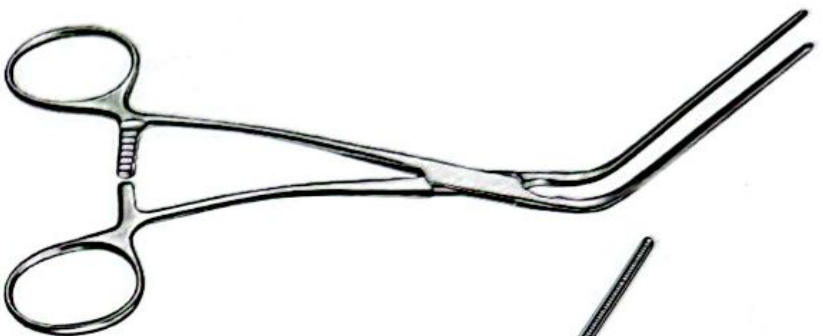

13-2516-13-2518
Leland-Jones



13-2516
18 cm



13-2517
19 cm



13-2518
20 cm

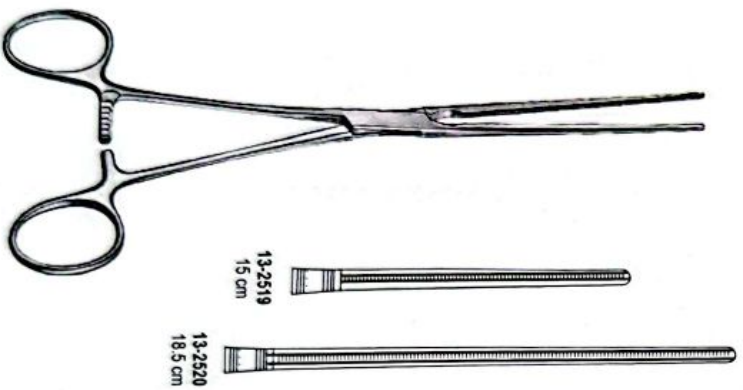

13-2519-13-2520
Bainbridge

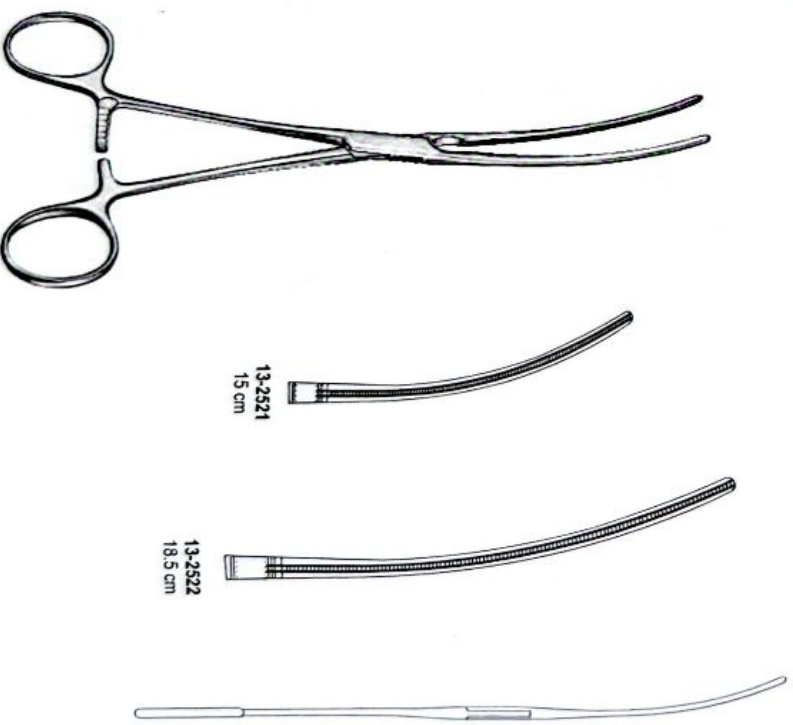

13-2521-13-2522
Bainbridge



Multi purpose Vascular Clamps, Aortic Aneurysm Clamps, Aortic Ligature Forceps

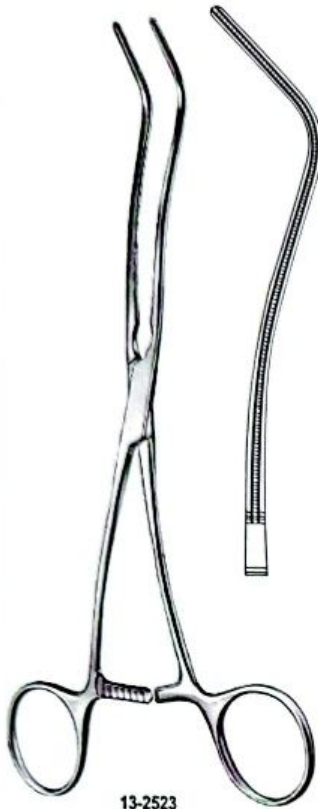

13-2523
De Bakey
20 cm



13-2524
De Bakey
28 cm



13-2525
De Bakey
30 cm



13-2526-13-2529
De Bakey



13-2526
26 cm



13-2527
27 cm



13-2528
31 cm



13-2529
33 cm



13-2530
Cooley
25 cm



Ligature Forceps, Aortic Clamps, Ligature Forceps

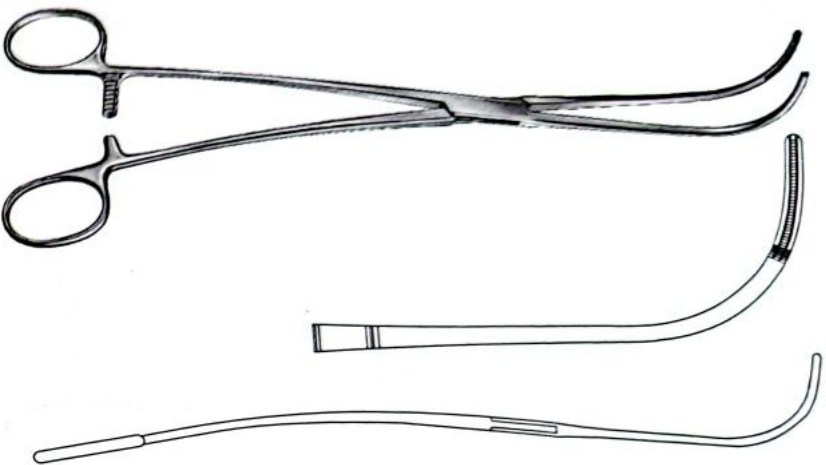

13-2531
De Bakey
24.5 cm

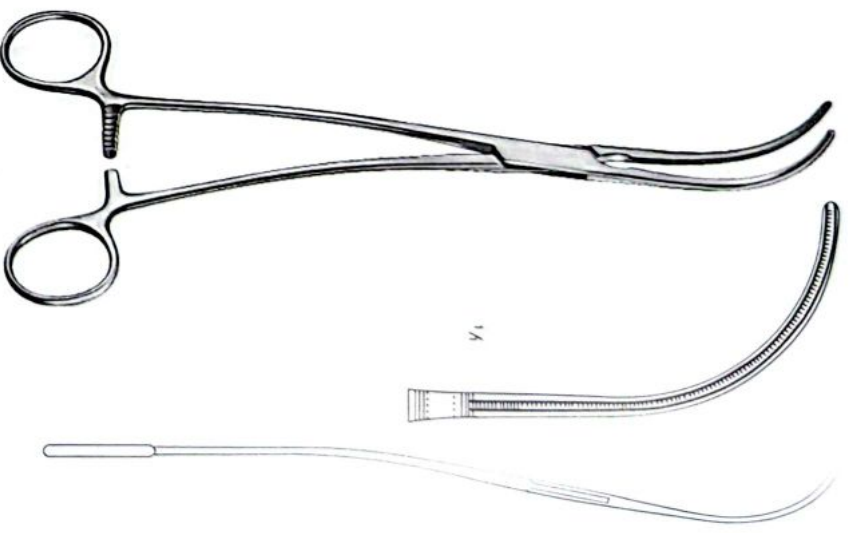

13-2532
De Bakey
24.5 cm

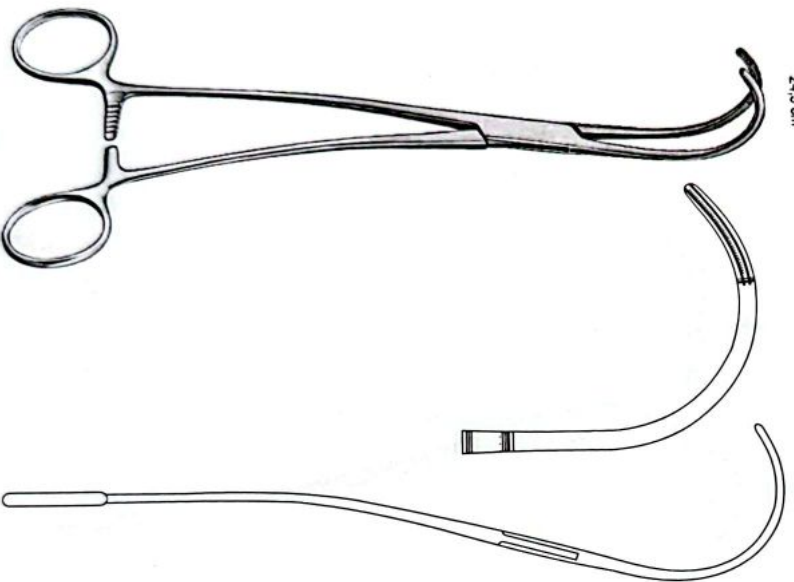

13-2533
De Bakey
27 cm

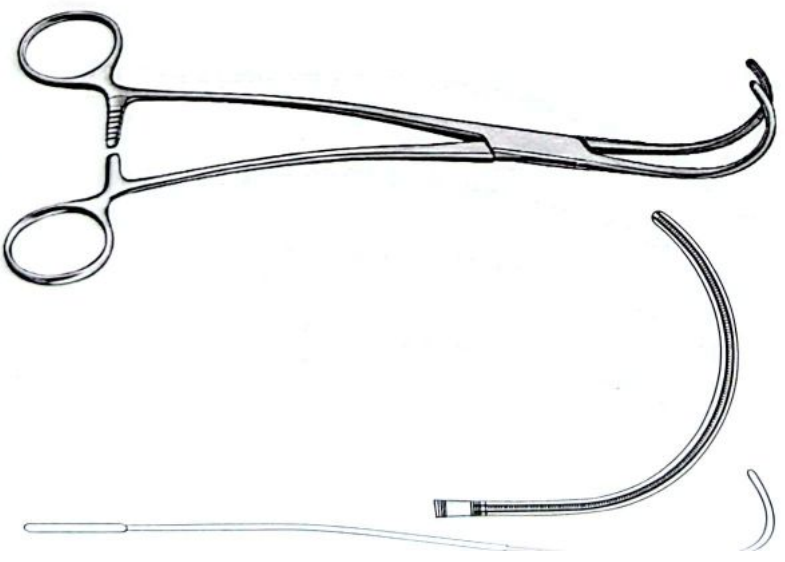

13-2534
De Bakey
27 cm



Cardiovascular Surgery

Aortic Clamps, Forceps for kidney and pancreas

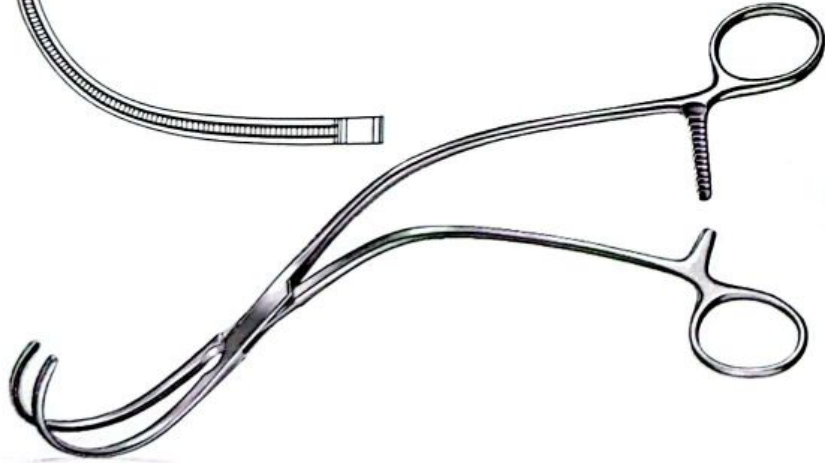

13-2535
Weber
24 cm

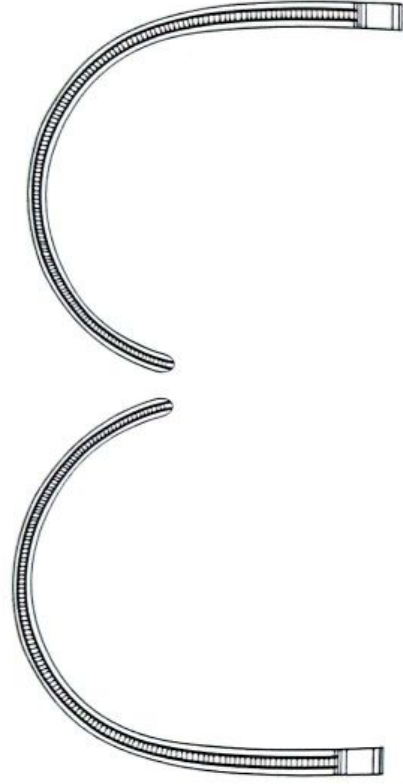

13-2536
Weber
24 cm

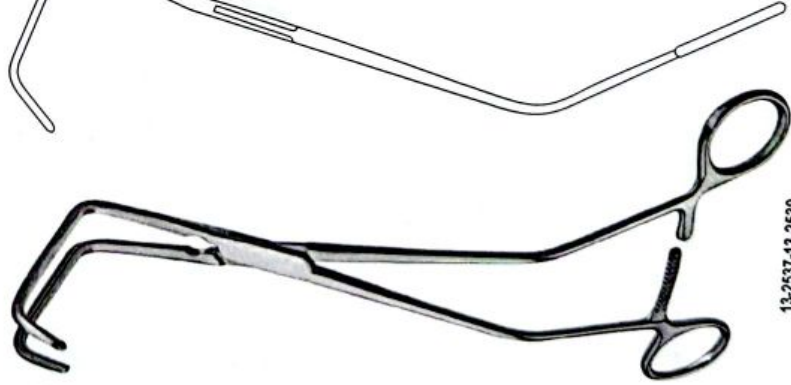
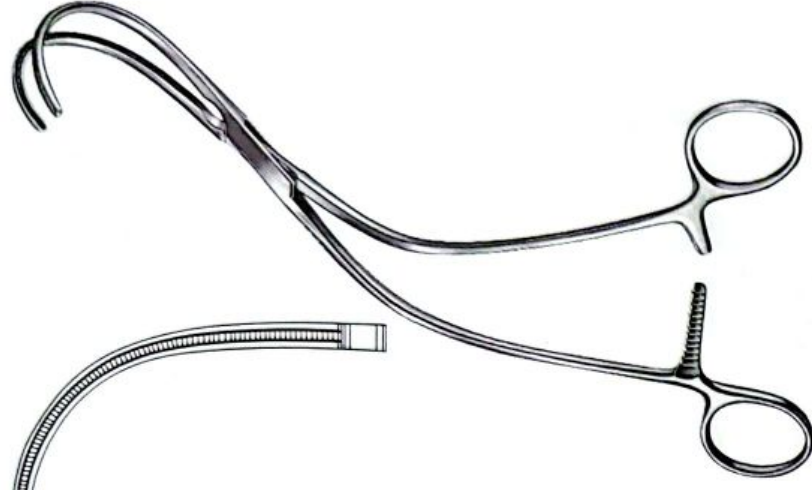

13-2537-13-2539

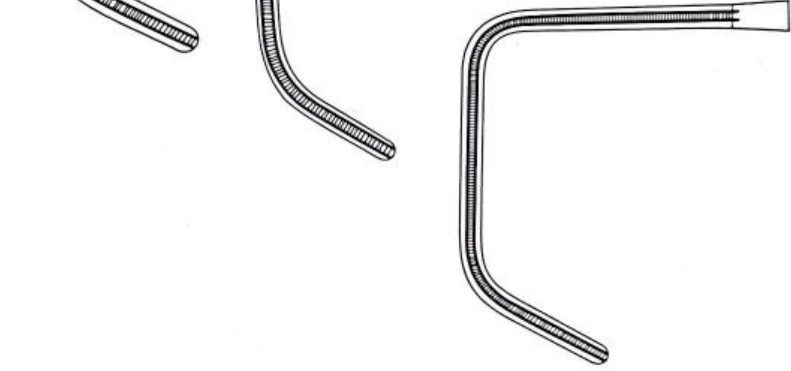
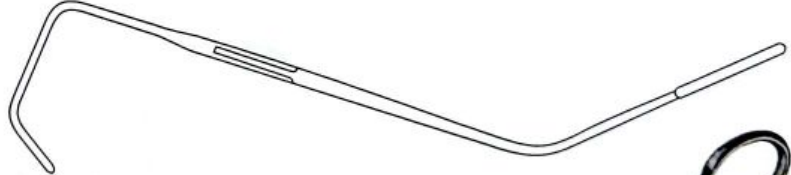

13-2537
20 cm

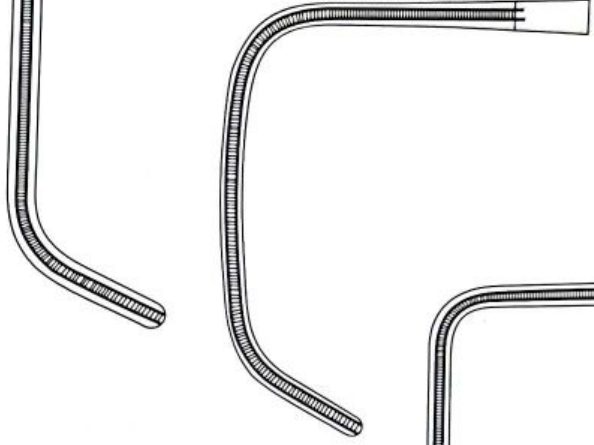

13-2538
20 cm

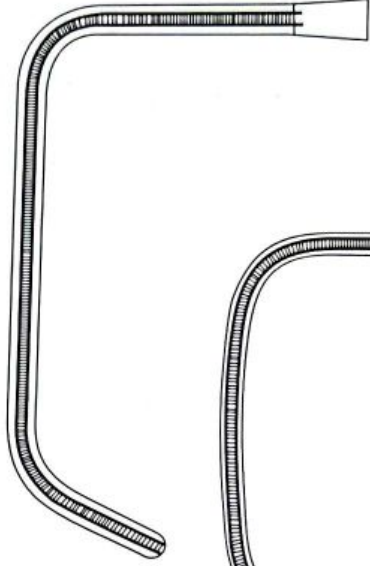

13-2539
20 cm



Forceps for kidney and pancreas,
Auricle Clamps, Bronchus Clamps

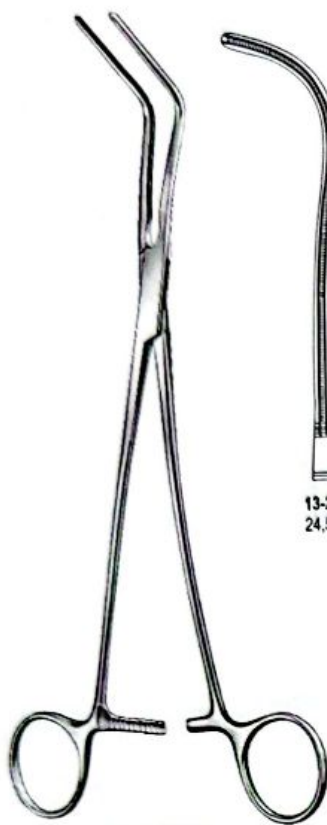

13-2540-13-2543
Harken



13-2540
24.5 cm



13-2541
24 cm



13-2542
23 cm



13-2543
23.5 cm



13-2544
Satinsky
15.5 cm

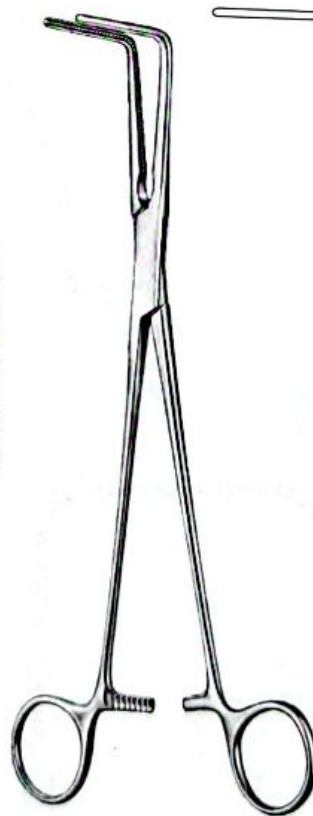
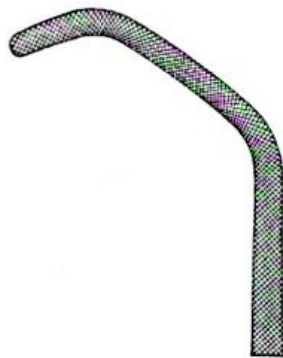

13-2545-13-2546
Lees



13-2545
23 cm



Bronchus Clamps, Anastomosis Clamps,
Aorta-Anastomosis Clamps

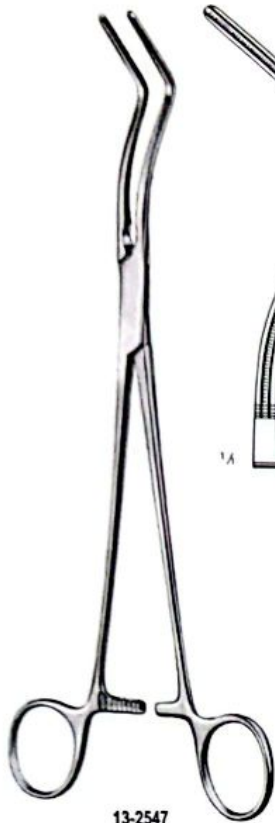

13-2547
Lees
26 cm

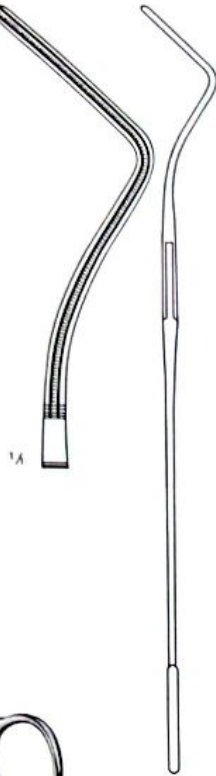

1/4



13-2548-13-2549
Glover



13-2548
18 cm



13-2549
22 cm



13-2550-13-2551
Lambert-Kay



13-2551
22.5 cm

13-2550
20.5 cm

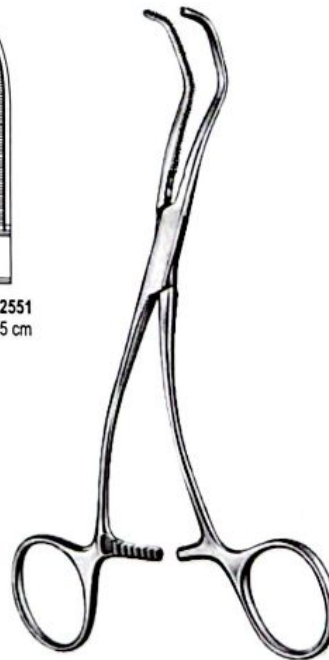

13-2552
De Bakey
16.5 cm



**Aortic Clamps, Aneurysm Clamps,
Multi purpose Vascular Clamps**



13-2553-13-2556
Morris-De Bakey



13-2553
18.5 cm

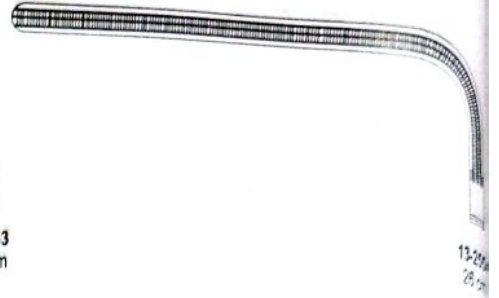

13-2554
29 cm

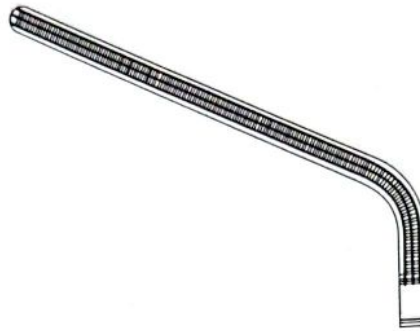

13-2555
27.5 cm



13-2556
26 cm



13-2557-13-2559
De Bakey-Bahnson



13-2557
23.5 cm

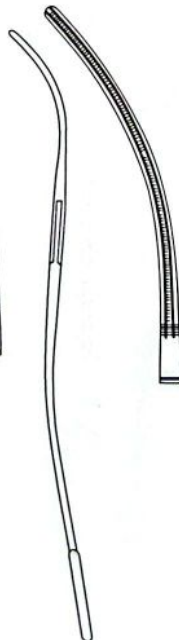

13-2558
24.5 cm



13-2559
25.5 cm



13-2560-13-2563
Potts



13-2560
21.5 cm



13-2561
23.5 cm



13-2562
27 cm



13-2563
31 cm



Multi purpose Vascular Clamps

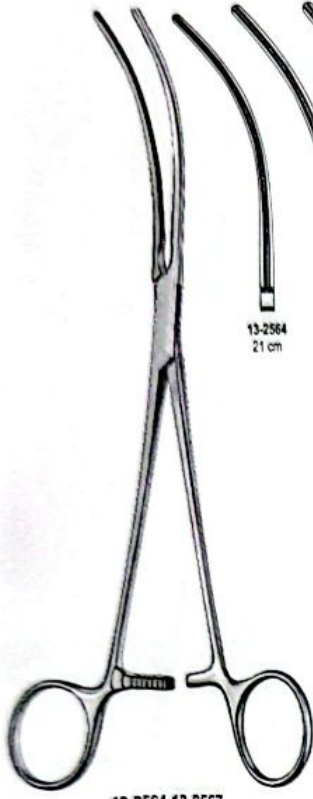

13-2564-13-2567
Potts

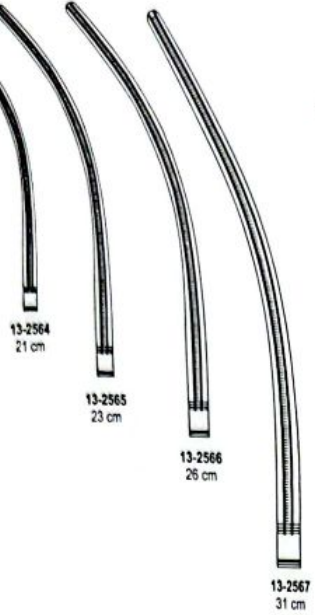

13-2564
21 cm

13-2565
23 cm

13-2566
26 cm

13-2567
31 cm



13-2568-13-2571
De Bakey



13-2568
27.5 cm



13-2569
23 cm



13-2570
20 cm



13-2571
19 cm



13-2571-13-2575
De Bakey-Bahnson



13-2572
21 cm

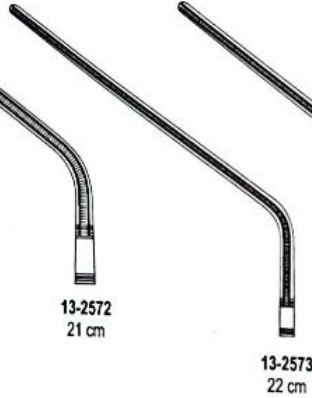

13-2573
22 cm



13-2574
26 cm

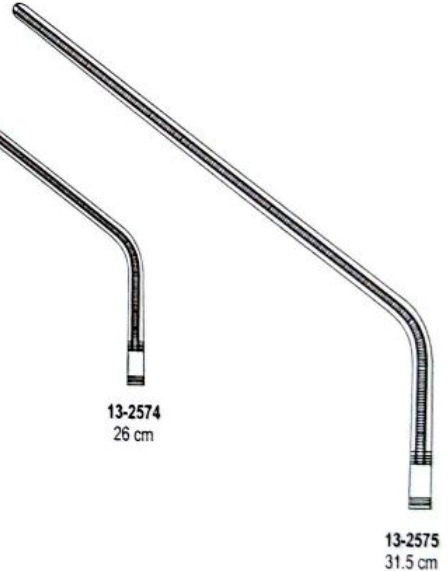

13-2575
31.5 cm

Haemostatic Forceps, Multi purpose
Vascular Clamps

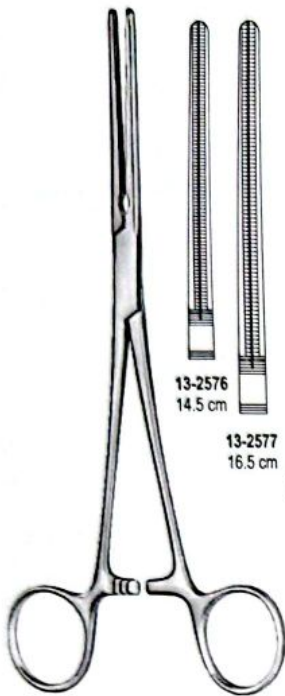

13-2576-13-2579
De Bakey-Pean

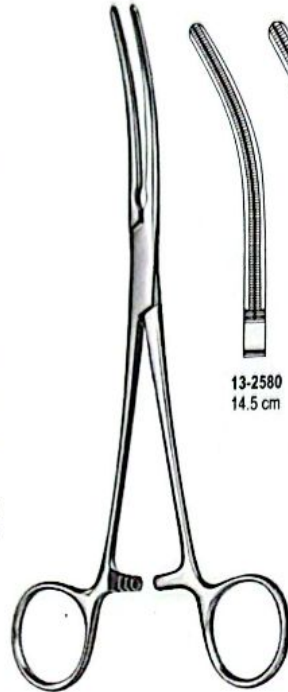

13-2580-13-2583
De Bakey-Pean

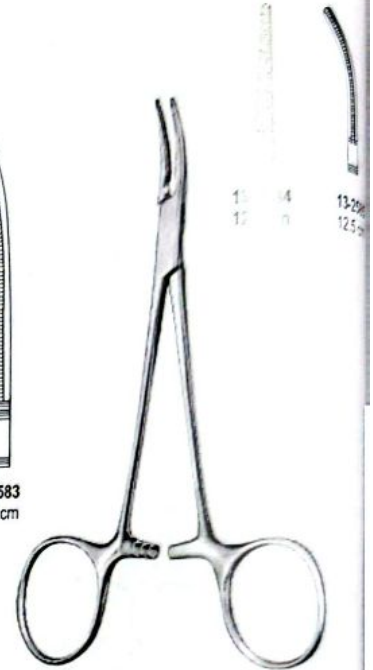

13-2584-13-2585
De Bakey-Mosquito

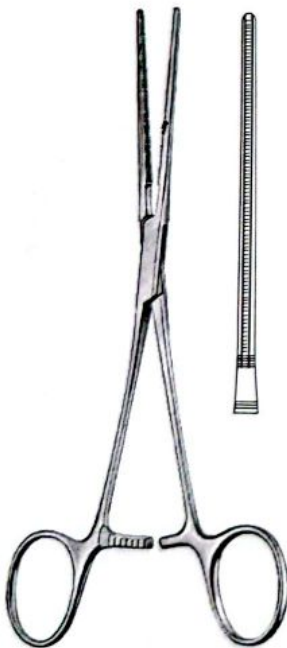

13-2586
De Bakey
17,5 cm

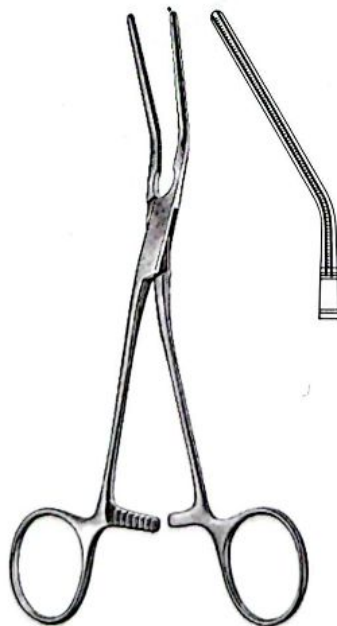

13-2587
De Bakey
16,5 cm



13-2588
De Bakey
16 cm



Haemostatic Forceps, Multi purpose
Vascular Clamps, Anastomosis Clamps



13-2589
De Bakley
15 cm

13-2590
De Bakley
16.5 cm

13-2591
Glover
17 cm

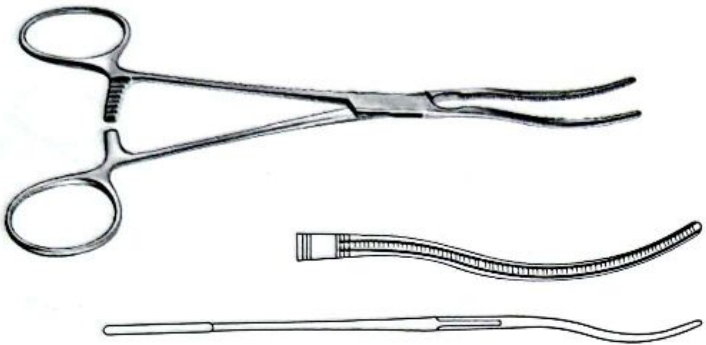

13-2592
Glover
17.5 cm

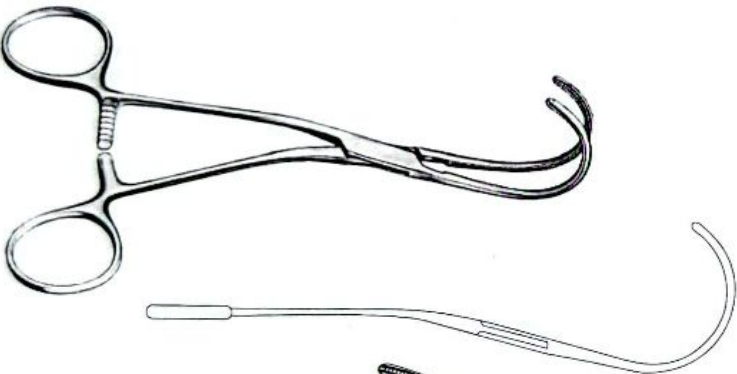

13-2593-13-2594
De Bakley

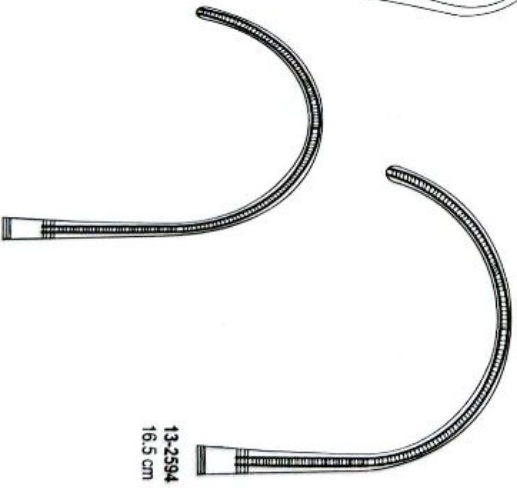

13-2593
16.5 cm

13-2594
16.5 cm



Anastomosis Clamps



13-2595-13-2597
Derra

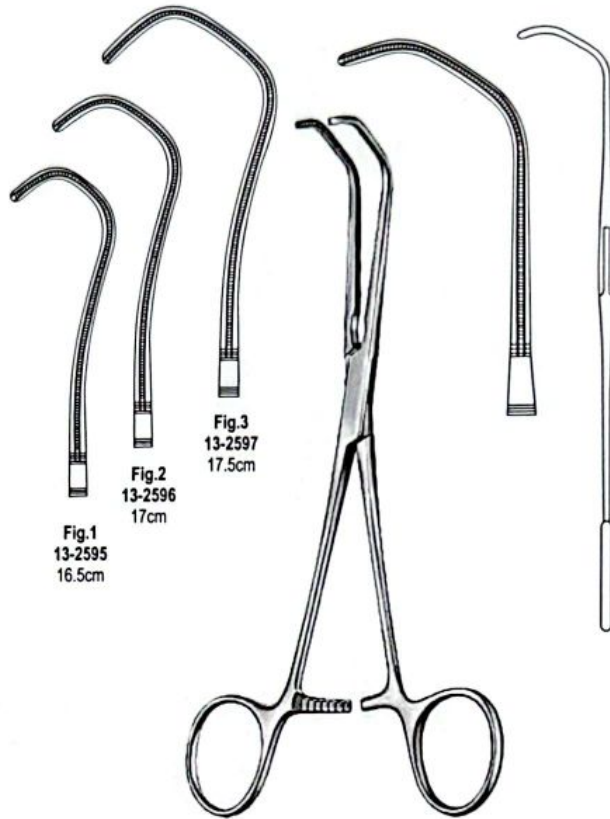

Fig.1
13-2595
16.5cm

Fig.2
13-2596
17cm

Fig.3
13-2597
17.5cm

13-2598
De Bakey-Beck
17 cm



13-2599
13 cm



13-2600
De Bakey
10 cm

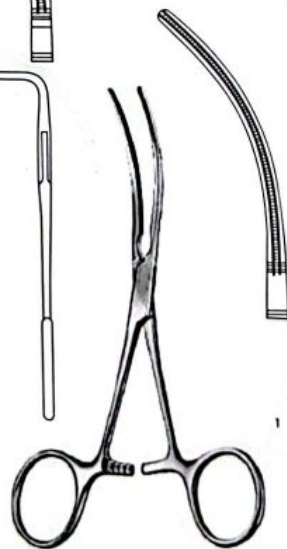

13-2601
De Bakey
13 cm



13-2602
De Bakey
12.5 cm



13-2603
De Bakey
12.5 cm



Pediatric Vascular Clamps, Anastomosis Clamps,
Multi purpose Vascular Clamps

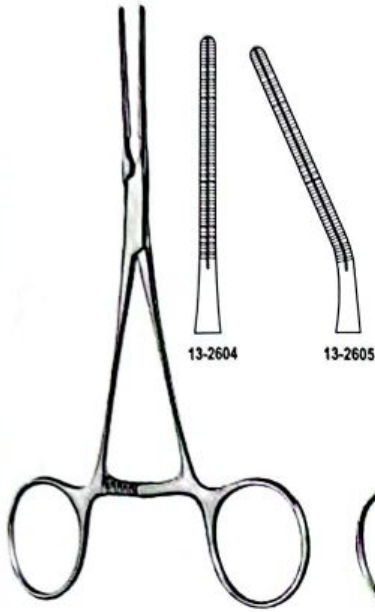

13-2604-13-2605
Cooley
14,5 cm



13-2606
Cooley
14,5 cm

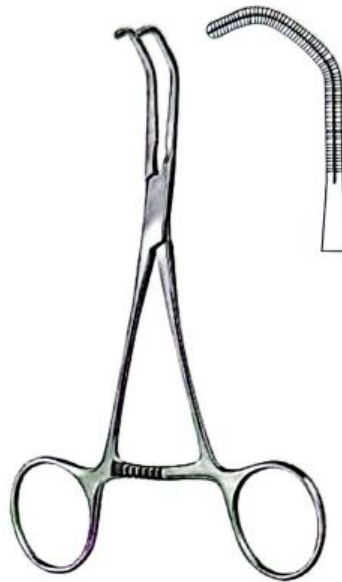

13-2607
Cooley
14 cm

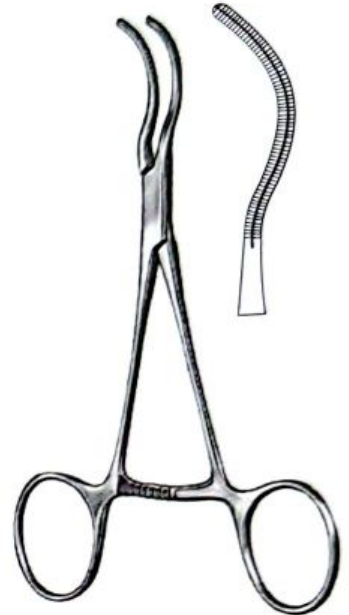

13-2608
Cooley
14,5 cm



13-2609
Cooley
20 cm

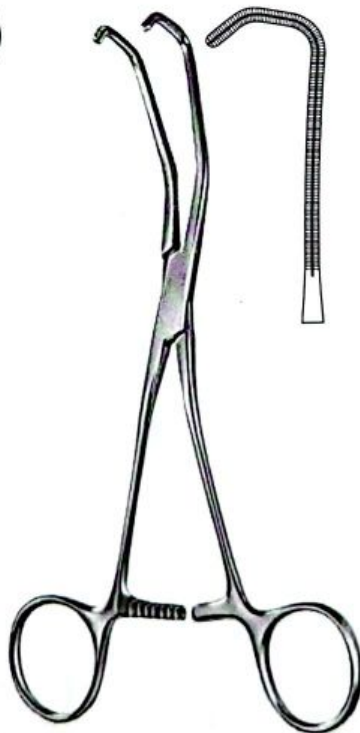

13-2610
Cooley
17 cm

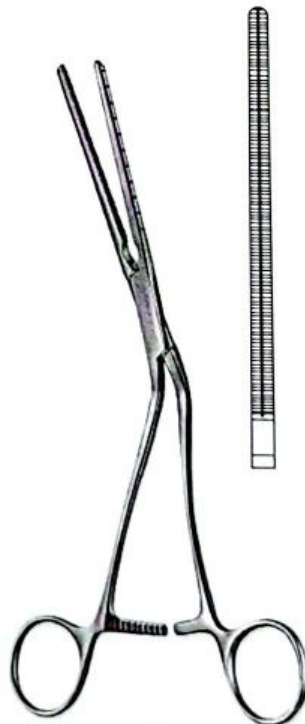

13-2611
Cooley
22 cm

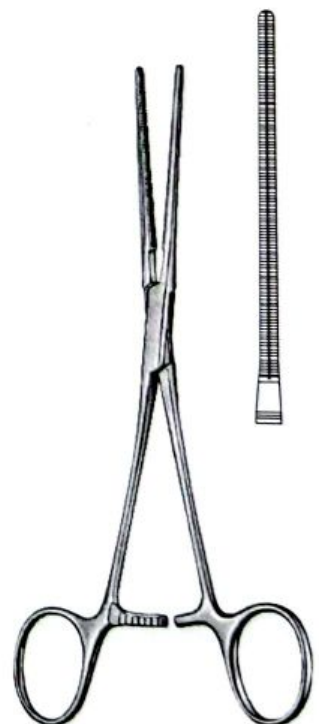

13-2612
Cooley
17 cm



Anastomosis Clamps, Multi purpose Vascular Clamps,

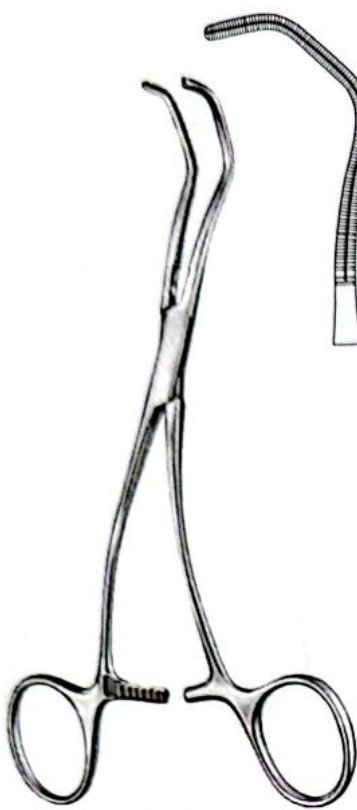

13-2613
Cooley
16 cm



13-2614
Cooley
14,5 cm

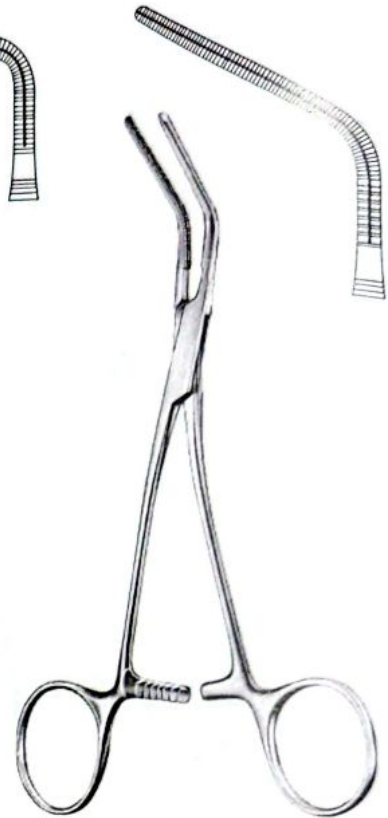

13-2615
Cooley
16 cm

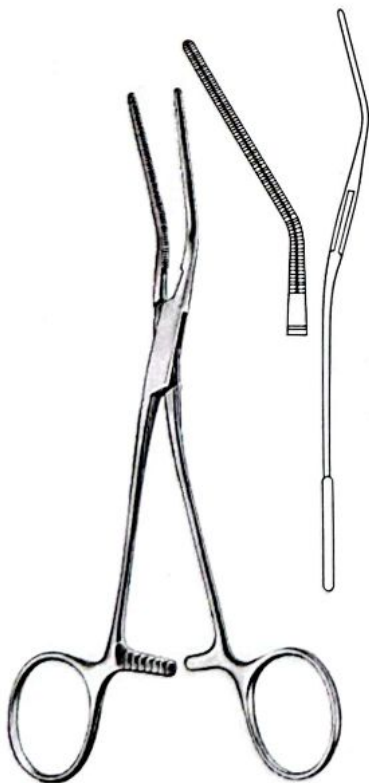

13-2616
Cooley
16,5 cm

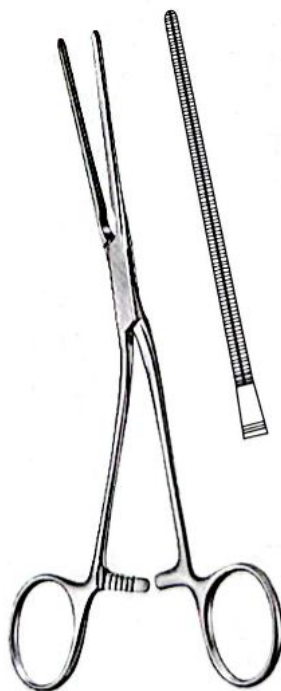

13-2617
Cooley
17 cm



13-2618-13-2620
Cooley-Derra



13-2618
16,5 cm

13-2619
17 cm

13-2620
17,5 cm



Anastomosis Clamps, Vascular Dilators,
Nerve Hooklets, Tourniquets



13-2621
Tubbs
spreading 8 - 42 mm, with fixation screw
for mitral stenosis

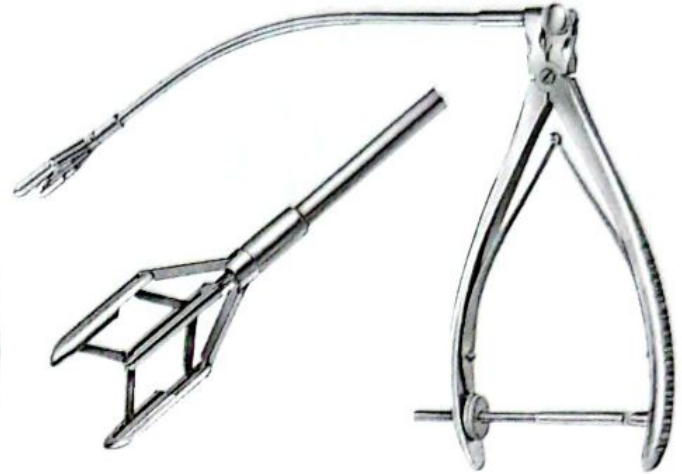

13-2622
Cooley
spreading 5 - 20 mm, with thread fixation
for mitral stenosis



13-2623-13-2634
De Bakey
19 cm

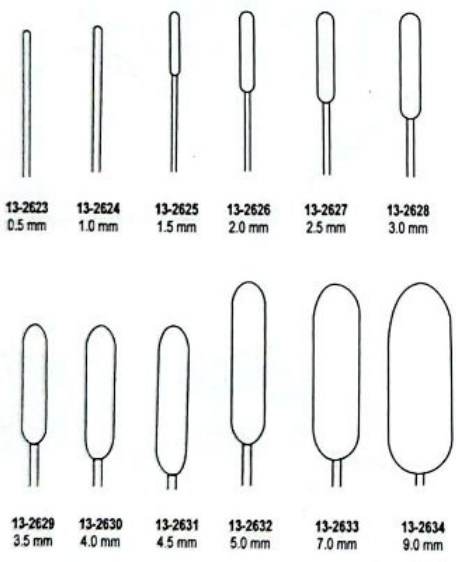

13-2635
Crile
20 cm



13-2636
Crile
20,5 cm



13-2637-13-2640
26 cm



13-2637
1.5 mm



13-2638
2.0 mm



13-2639
2.5 mm



13-2640
3.0 mm





13-2642-13-2648
Castañeda

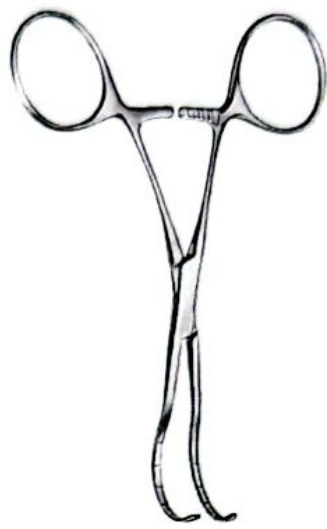

13-2641
Subramanian-Miniature
16,5 cm

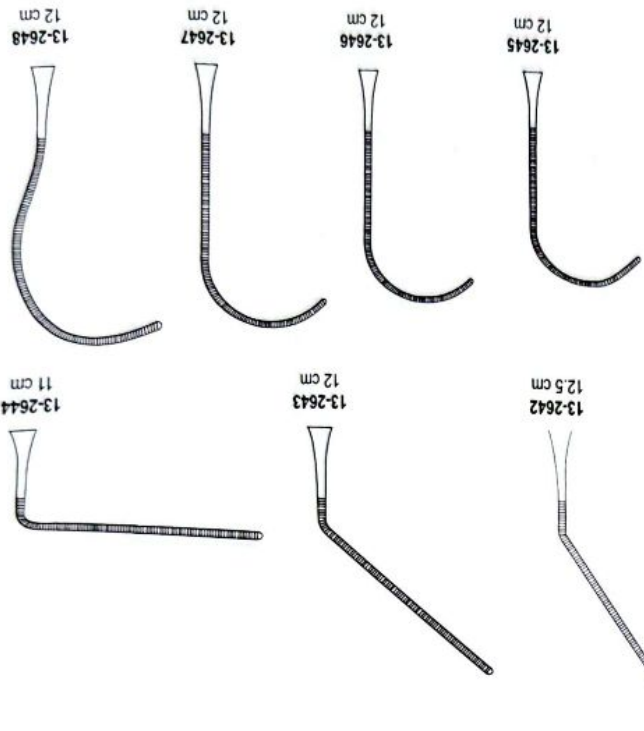

Pediatric Aortic Clamps, Pediatric Vascular Clamps

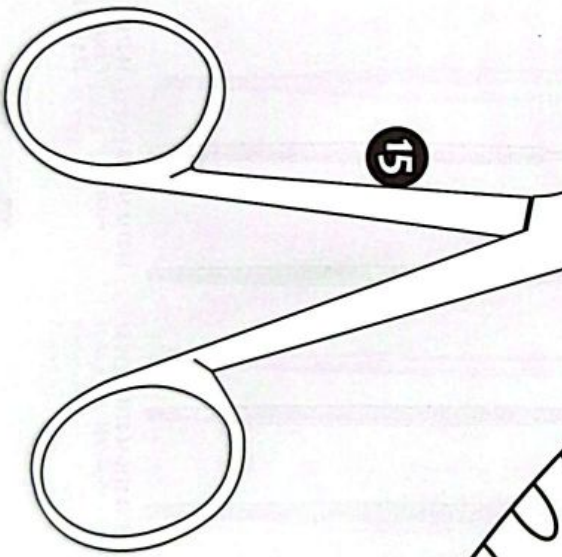
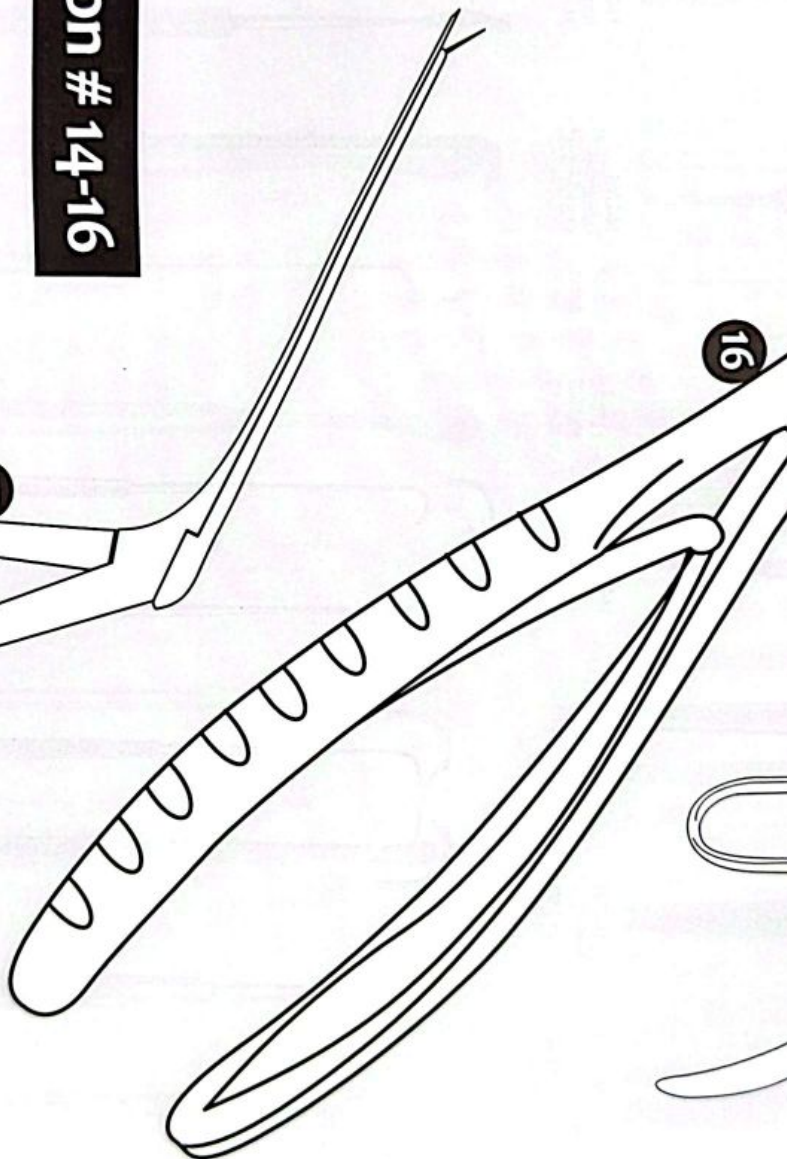
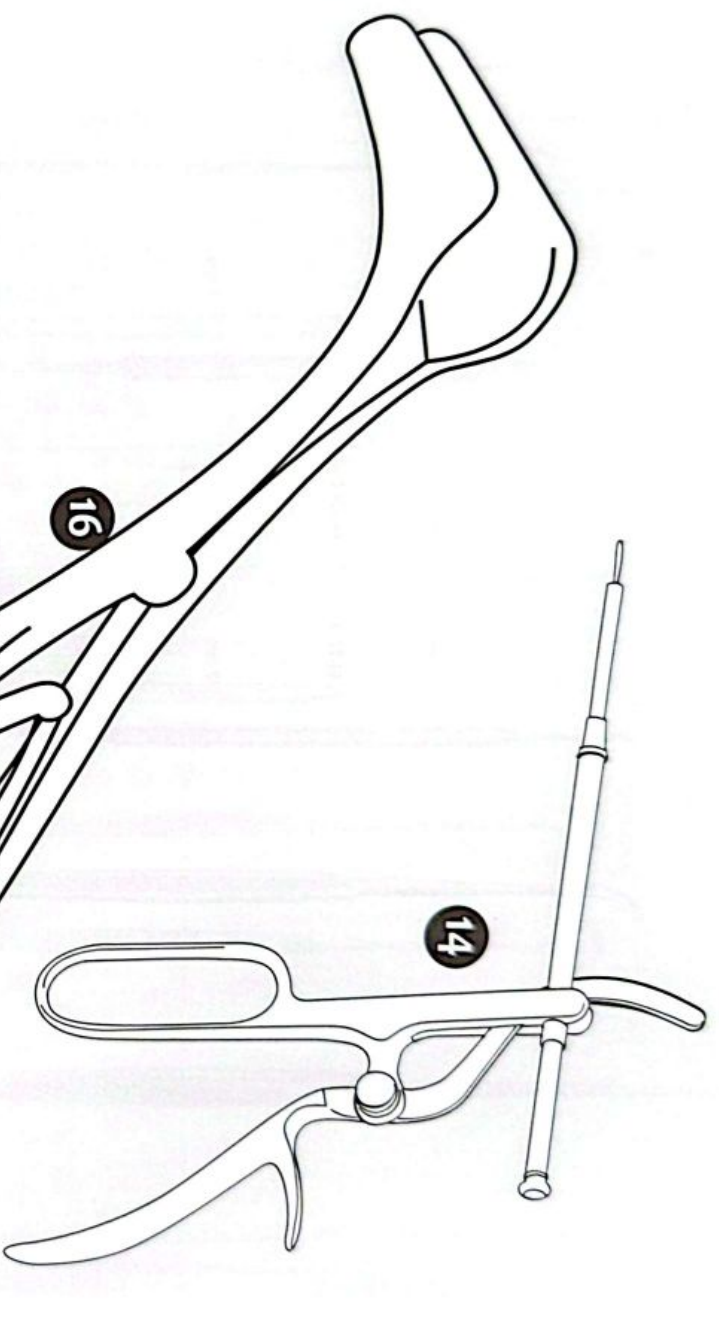

Section # 14-16

- 14 Tonsil
- 15 Otolaryngology
- 16 Rhinology

Cleft Palate Needles, Tonsil Knife



14-2700
Hurd
20.5 cm / 8 1/8"



14-2701
Hurd
20.5 cm / 8 1/8"



14-2702
Day
21.5 cm



14-2703-14-2704
Luniatschek
17.5 cm / 6 7/8"

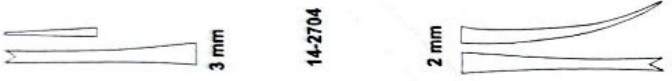

14-2704



14-2705
Luniatschek
17.5 cm / 6 7/8"



14-2706
Nager
24 cm / 9 1/2"



14-2707
Falk
24 cm / 9 1/2"



14-2708
Falk
24 cm / 9 1/2"



14-2709
Claus-Etken
23 cm / 9"



14-2710-14-2711
DURHAM

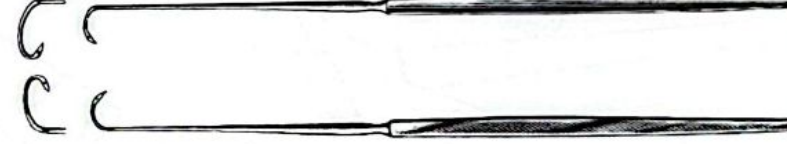

14-2712-14-2713
Rotter



14-2715
Douglas
21 cm / 8 1/4"



14-2716
Brünings
23 cm / 9"



14-2717
Carpenter
25 cm / 9 7/8"



4.5 mm

9.0 mm

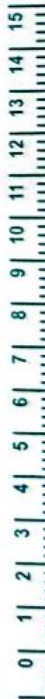

Cleft Palate Needles, Tonsil Knife,
Tonsil Dissectors

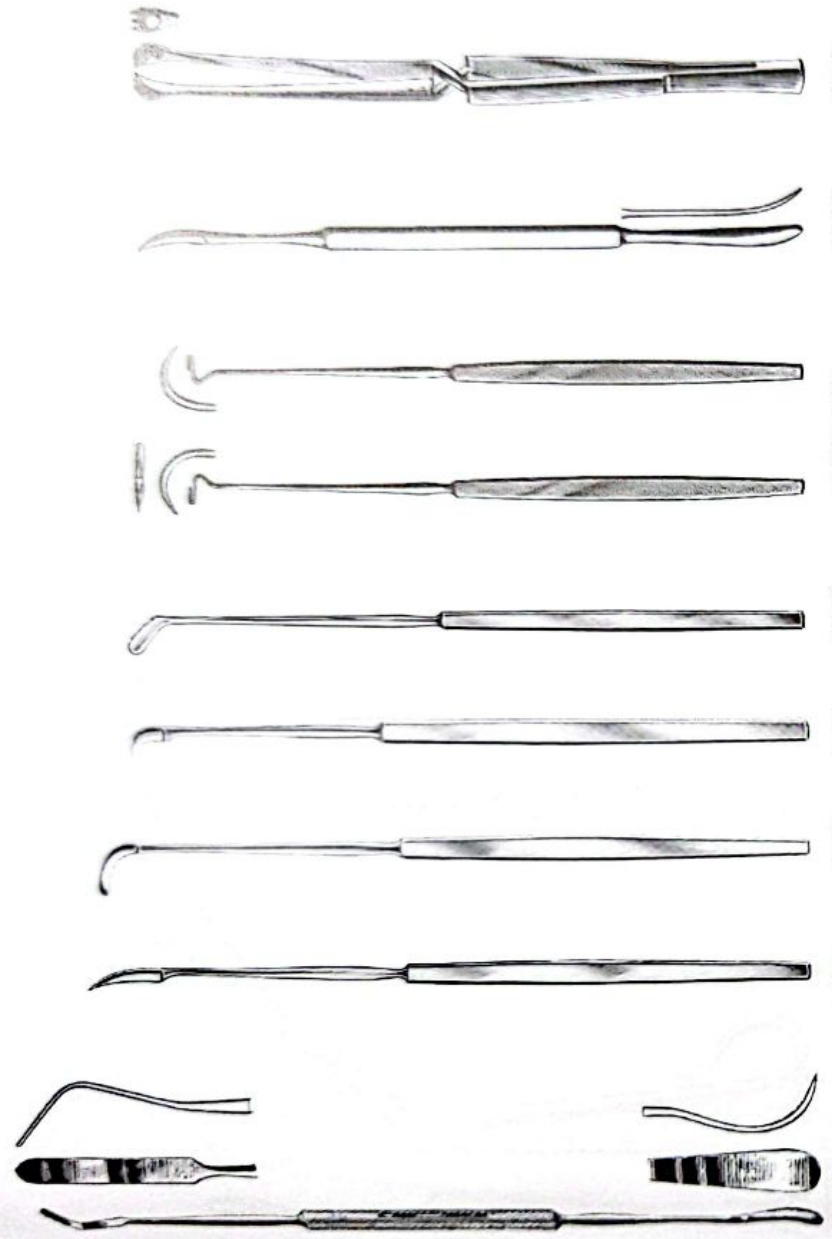

14-2718
Carpenter
25.0cm

14-2719
Abraham
21 cm/8 1/4"

14-2720
Tydins
21 cm

14-2721
Canfield
21 cm/8 1/4"

14-2722
Colver
22.5 cm

14-2723-14-2724
Dupuy-Weiss
22 cm

14-2725
Lynch
20 cm

14-2726
Marschik
22 cm



14-2727
Hug
2.5 cm/8 3/8"

14-2728
Henke
24.5 cm/9 9/16"

14-2729
Henke
24.5 cm/9 9/16"

5.0mm

11.5mm

16.5mm

5.0mm

14-2730
Mollison Pillar
double ended
21cm/8 1/4"

14-2731
Gwynne Evans Dissector
double ended,
6mm, 20cm/8"
8mm, 20cm/8"

14-2732
Yankauer
21cm/8 1/4"

14-2733
Negus Knot Tier
and Pusher
20 cm/8"

Tonsil Dissectors, Tonsil Seizing Forceps



14-2734
Nager
23 cm/9"



14-2735
Love
23 cm/9"



14-2736
Haslinger



14-2737
Hofer
24 cm/9 1/2"



14-2738-14-2739
TJVNEN-TJVDING
21.0cm

14-2737
Fig. 1

14-2739
Fig. 2



14-2740
MUSEUX
20.0cm



14-2741
MUSEUX
20.0cm



14-2742
BALLENGER
21.5cm

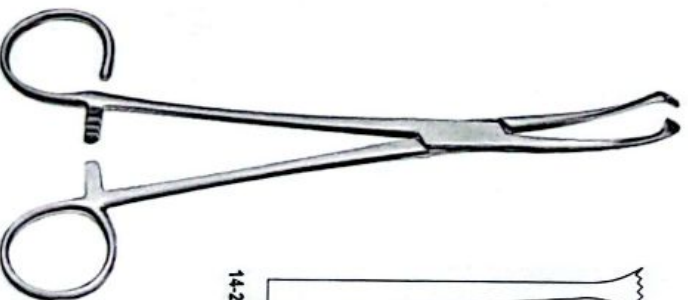

14-2743
White
18 cm / 7 1/8"

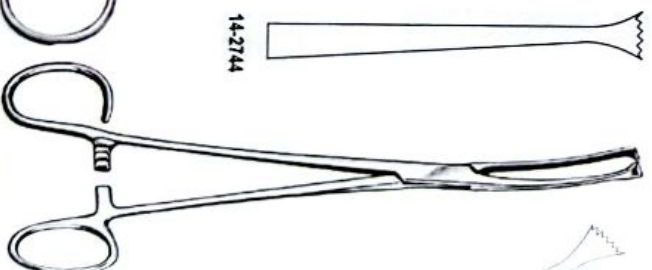

14-2744-14-2745
COLVER
19.0cm

14-2744

14-2745



Tonsil Dissectors, Tonsil Seizing Forceps

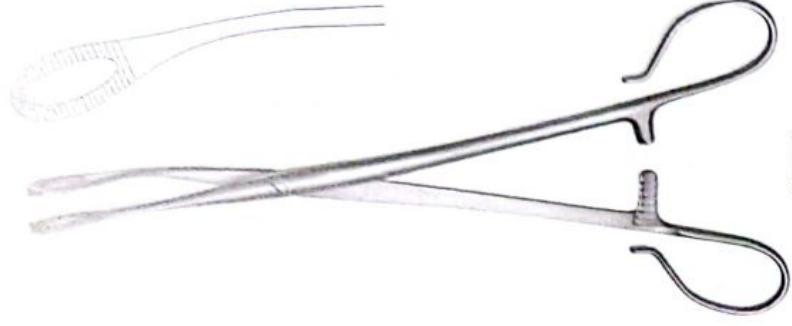

14-2750
Blomke
20 cm / 7 7/8"

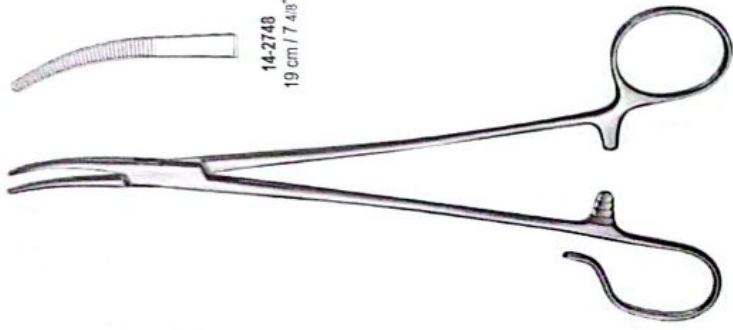

14-2748-14-2749
Schnidt

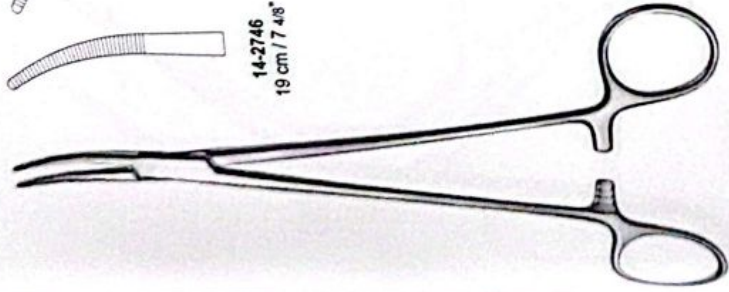

14-2746-14-2747
Schnidt

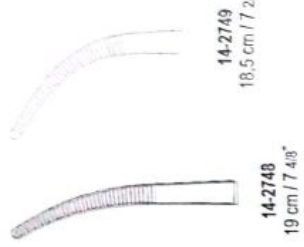

14-2748
19 cm / 7 4/8"

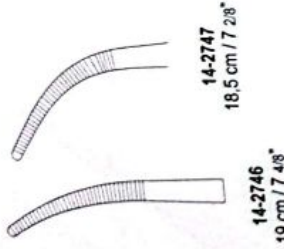

14-2746
19 cm / 7 4/8"

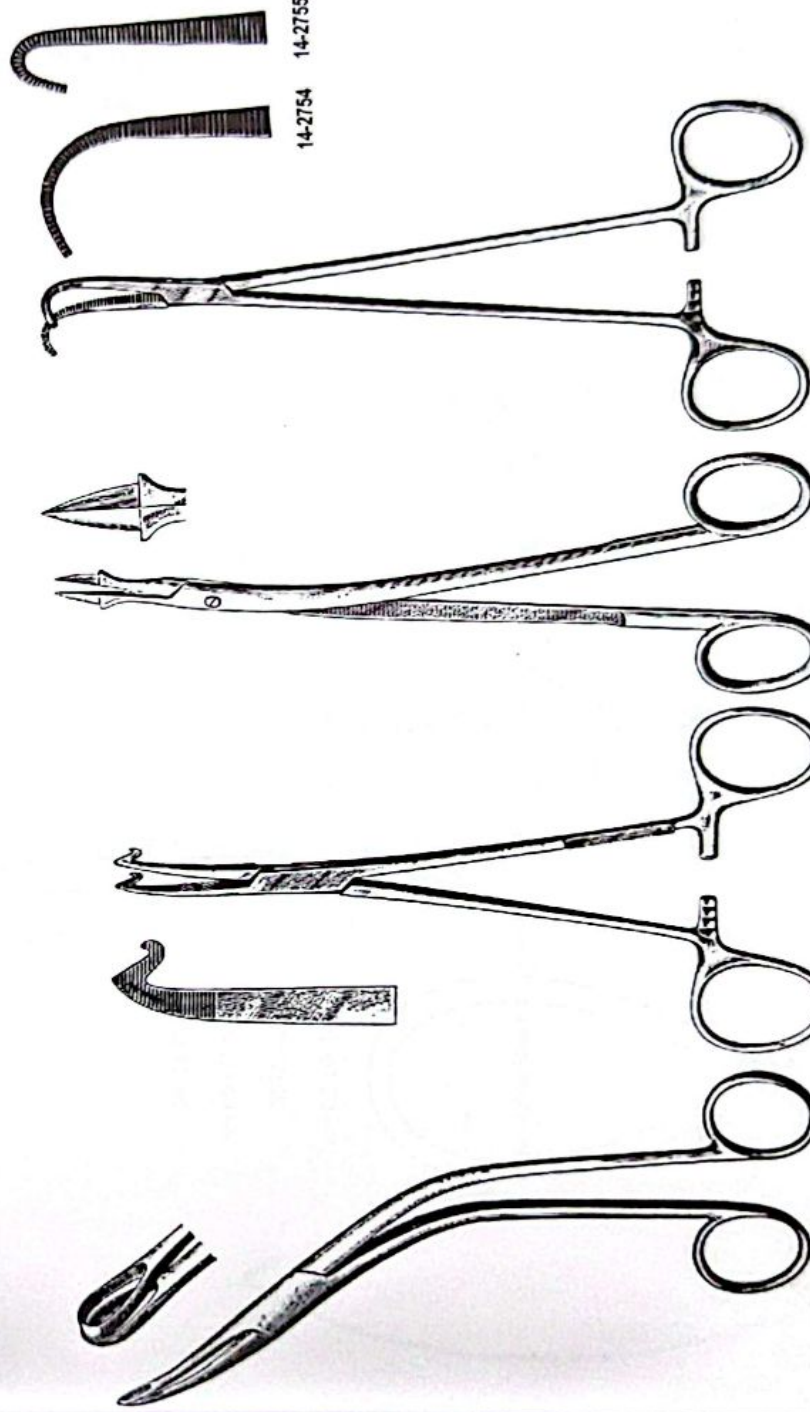

14-2752
McWHORTER-LOTHROP
18.0cm

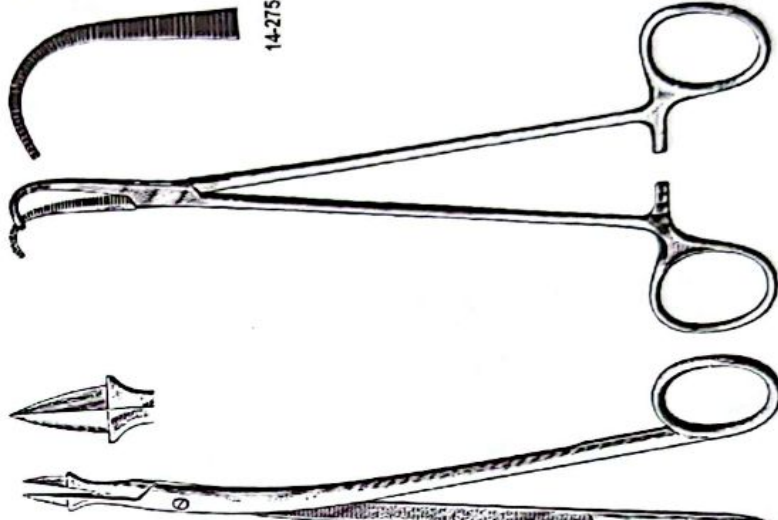

14-2753
THILENIUS
20.0cm

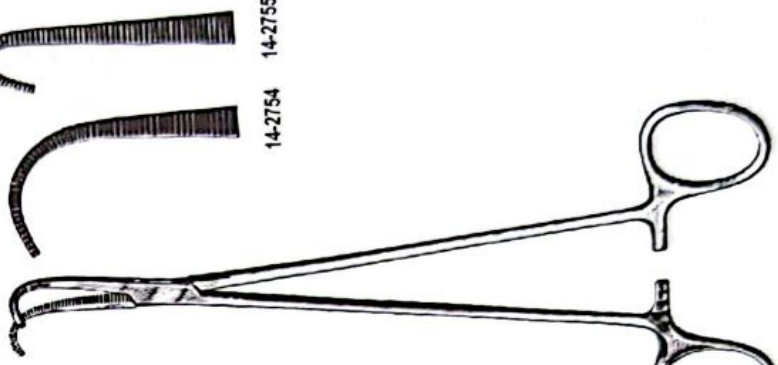

14-2754-14-2755
NEGUS
19.0cm

14-2751
DENIS-BROWNE
18.0cm
21.0cm



Tonsil Seizing Forceps, Tonsil Snares



14-2756
BIRKETT
19.0cm



14-2757
WILSON
19.0cm



14-2758
Mollison
18.0cm (with horizontal opening)
18.0cm (with vertical opening)



14-2759
Eves
28.5 cm / 11 2/8"



14-2760
Eves
28.5 cm / 11 2/8"



14-2761
Brünings
29 cm / 11 3/8"

39-511-40
Ø 40 x 0,3 mm
39-511-50
Ø 50 x 0,3 mm



14-2762



Tonsil Snares, Broncho-Esophagoscopy Forceps

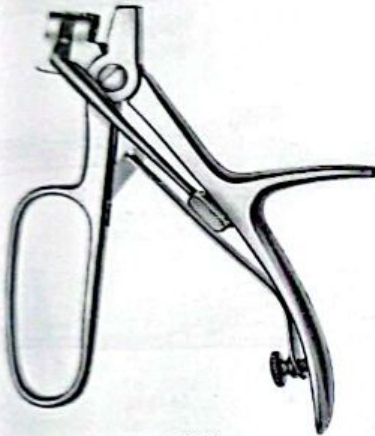

14-2763
Huber

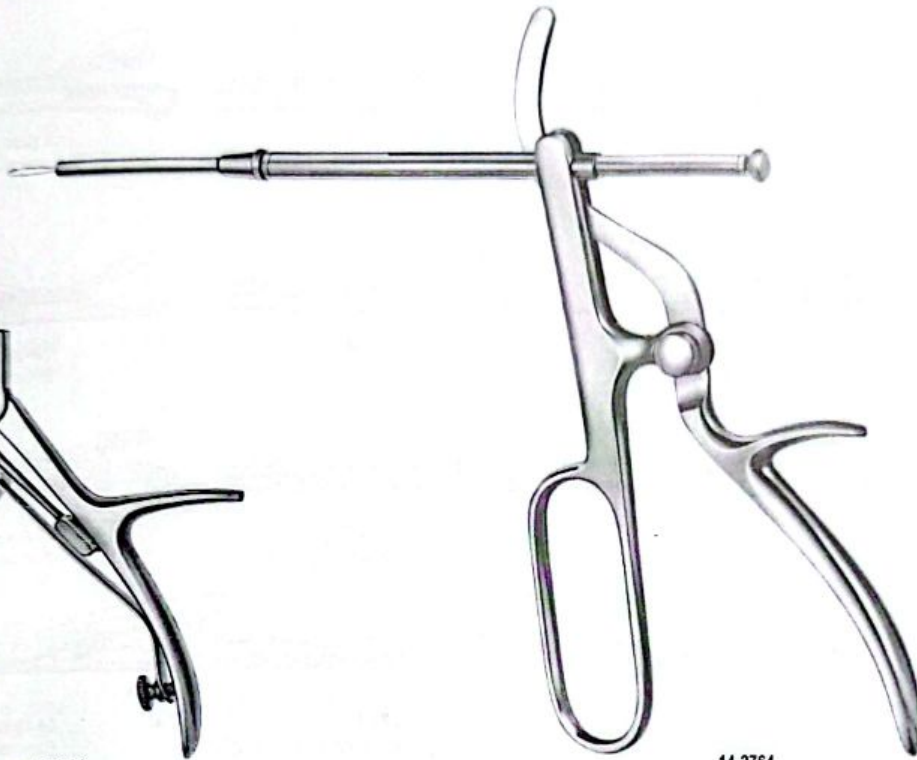

14-2764
Tyding



14-2765
Brünings

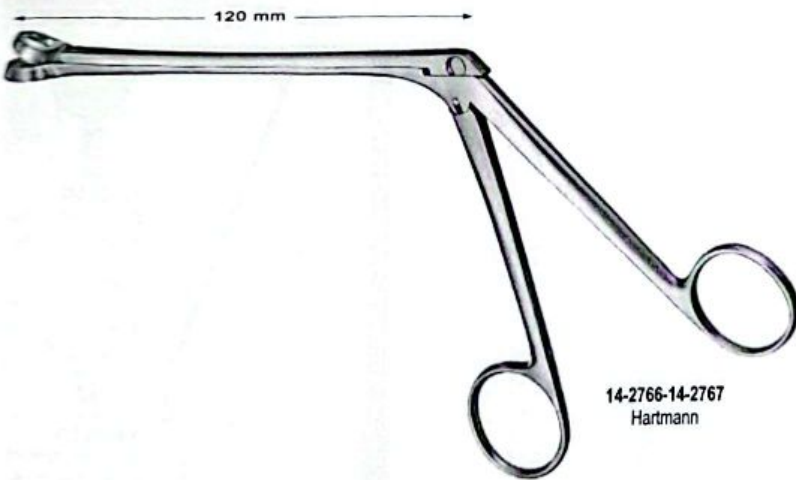

14-2766-14-2767
Hartmann



14-2766
Schnitt
cut
corte
tranchant
tagliante
Ø 13 mm

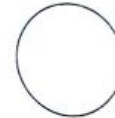

14-2767
Schnitt
cut
corte
tranchant
tagliante
Ø 15 mm



14-2768-14-2795
CHEVALIER-JACKSON



14-2796
Brünings

30.0cm	14-2768	14-2772	14-2776	14-2780	14-2784	14-2788	14-2792
40.0cm	14-2769	14-2773	14-2777	14-2781	14-2785	14-2789	14-2793
50.0cm	14-2770	14-2774	14-2778	14-2782	14-2786	14-2790	14-2794
60.0cm	14-2771	14-2775	14-2779	14-2783	14-2787	14-2791	14-2795

Exchangeable Tips



14-2797
Fraenkel



14-2798
Seiffert



14-2799
Fraenkel



14-2800
Scheinmann



14-2801
Scheinmann



14-2802
Brünings



14-2803
Lange



14-2804
Brünings



14-2805
Krause



14-2806
Krause



14-2807
Cordes



14-2808
Schumacher



14-2809
Cordes



14-2810
Cordes



14-2811
Rosenberg



14-2812
Baracani

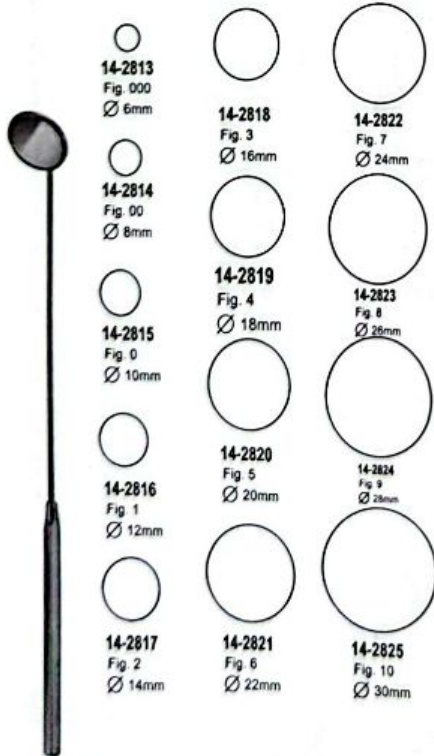

14-2813
Fig. 000
Ø 6mm



14-2818
Fig. 3
Ø 16mm



14-2822
Fig. 7
Ø 24mm



14-2814
Fig. 00
Ø 8mm



14-2819
Fig. 4
Ø 18mm



14-2823
Fig. 8
Ø 26mm



14-2815
Fig. 0
Ø 10mm



14-2820
Fig. 5
Ø 20mm



14-2824
Fig. 9
Ø 28mm



14-2816
Fig. 1
Ø 12mm



14-2821
Fig. 6
Ø 22mm



14-2825
Fig. 10
Ø 30mm

14-2813-14-2825
Laryngeal mirrors with
hexagonal handle
Size: 180 mm



14-2826
FRANCKE
Automatic
blood lancet



14-2827
Mirror handle
Size: 105 mm



14-2828
KOLLE
Microscopic
Needle Holder
with plastic
handle.
Size: 240 mm



14-2829
Mirror handle
Size: 110 mm



14-2830
Spare mirrors
Size: 12 mm

14-2831
Spare mirrors
Size: 14 mm

14-2830-14-2831
MICHEL Rhinoscopic
mirrors with interchangeable
mirror inserts, Size: 250 mm

Ear Specula

①
Fig. 0
15-2903
3.6 cm
Ø 3.0 mm

②
Fig. 1
15-2904
3.6 cm
Ø 4.0 mm

③
Fig. 2
15-2905
3.6 cm
Ø 5.0 mm

④
Fig. 3
15-2906
3.6 cm
Ø 6.0 mm

⑤
Fig. 4
15-2907
3.6 cm
Ø 7.5 mm



Hartmann
15-2903-15-2907

①
Fig. 0
15-2900
Ø 3 mm

②
Fig. 1
15-2901
Ø 4 mm

③
Fig. 2
15-2902
Ø 5 mm



Hartmann (for children)
15-2900-15-2902

①
Fig. 1
15-2908
3.6 cm
Ø 4.0 mm

②
Fig. 2
15-2909
3.6 cm
Ø 5.0 mm

③
Fig. 3
15-2910
3.6 cm
Ø 6.0 mm

④
Fig. 4
15-2911
3.6 cm
Ø 7.5 mm



Toynbee
15-2908-15-2911

①
Fig. 1
15-2912
3.6 cm
Ø 5.5 mm

②
Fig. 3
15-2914
3.6 cm
Ø 7.5 mm

③
Fig. 5
15-2916
3.6 cm
Ø 9.5 mm



Farnior
15-2912-15-2918

④
Fig. 2
15-2913
3.6 cm
Ø 6.5 mm

⑤
Fig. 4
15-2915
3.6 cm
Ø 8.5 mm

⑥
Fig. 6
15-2917
3.6 cm
Ø 10.5 mm

⑦
Fig. 7
15-2918
3.6 cm
Ø 11.5 mm

①
Fig. 1
15-2922
Ø 4.5 mm

②
Fig. 2
15-2923
Ø 5.5 mm

③
Fig. 3
15-2924
Ø 6.5 mm

④
Fig. 4
15-2925
Ø 7.5 mm



Gruber (for adults)
15-2922-15-2925

①
Fig. 1
15-2926
Ø 4.5 mm

②
Fig. 2
15-2927
Ø 5.5 mm

③
Fig. 3
15-2928
Ø 6.5 mm

④
Fig. 4
15-2929
Ø 7.5 mm



Gruber
15-2926-15-2929

①
Fig. 1
15-2930
Ø 3 mm

②
Fig. 2
15-2931
Ø 4.5 mm

③
Fig. 3
15-2932
Ø 5.5 mm

④
Fig. 4
15-2933
Ø 6.5 mm



Poltizer
15-2930-15-2933

①
Fig. 1
15-2919
Ø 6 mm

②
Fig. 2
15-2920
Ø 7 mm

③
Fig. 3
15-2921
Ø 8 mm



Troeltsch
15-2919-15-2921

Ear Specula, Ear Syringes, Tuning Forks



Single
15-2934



15-2935



Bruenings
15-2936



15-2937

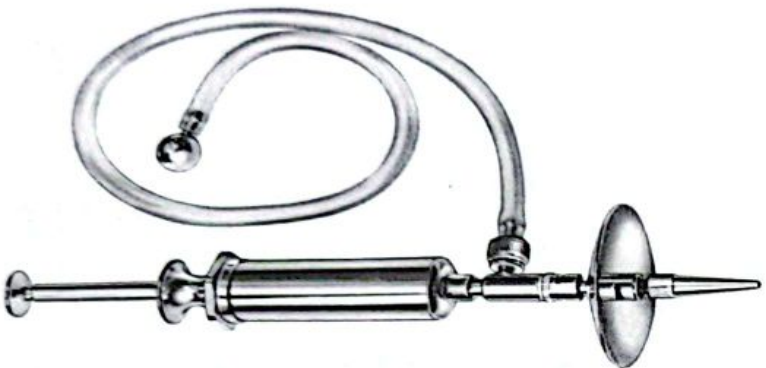

15-2938



15-2939





















15-2940

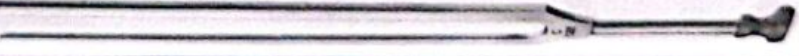
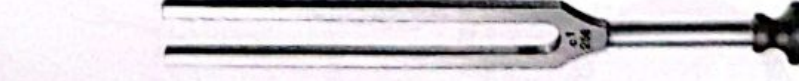

Lucas

Tuning Forks

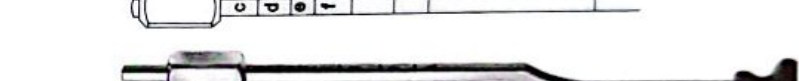
									
Hartmann 15-2941 C 128	Hartmann 15-2943 C2 512	Hartmann 15-2944 C3 1024	Hartmann 15-2945 C4 2048	Hartmann 15-2946 C5 4096	French 15-2947 C2 16	French 15-2948 C1 32	Hartmann 15-2949 C 64	Hartmann 15-2950 C 128	Hartmann 15-2951 C 256

									
15-2952 C 128	15-2953 C 256	15-2954 C 512	15-2955 C 1024	15-2956 C 2048	15-2957 C 4096	15-2958 C 128	15-2959 C 128	15-2960 C 256	15-2960 C 256



Tuning Forks, Ear Catheters, Polypus Snares

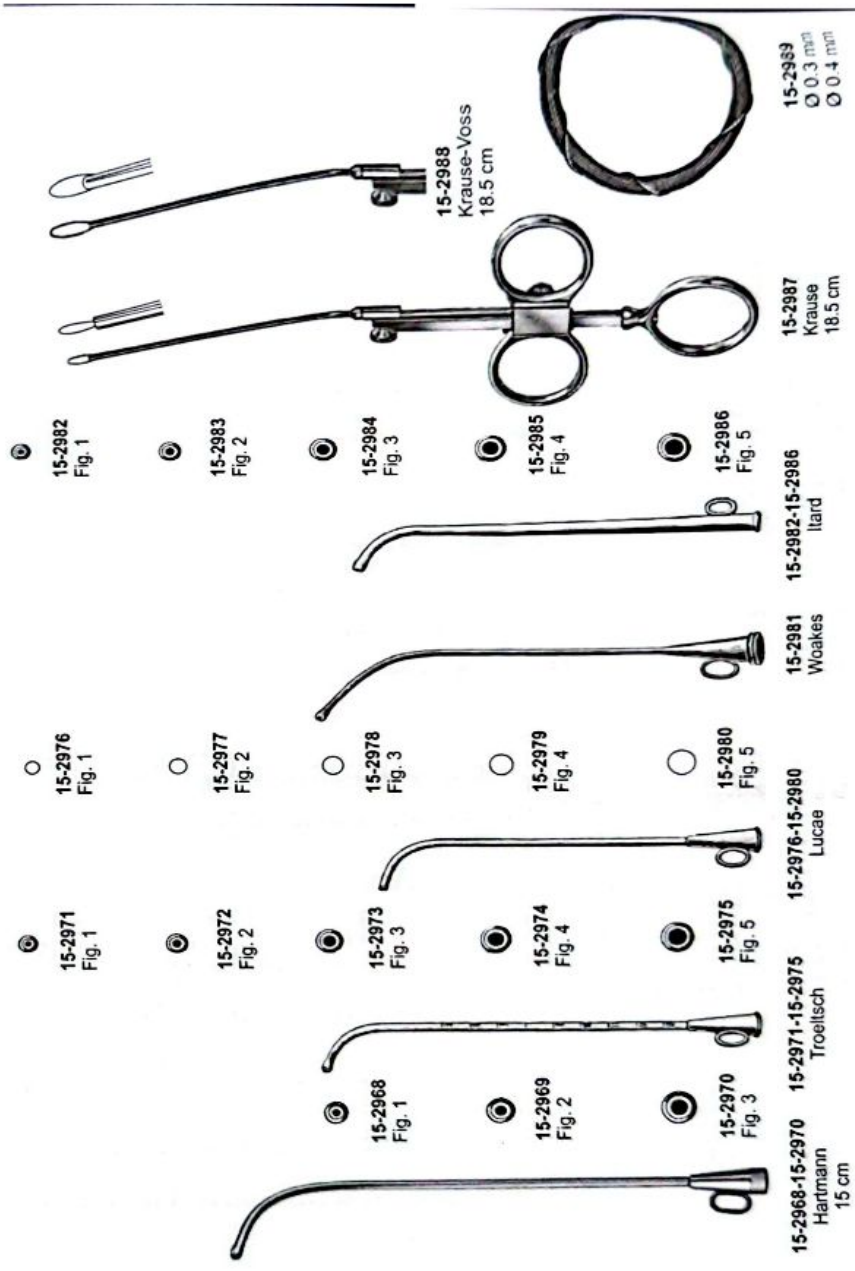

Ear Forceps, Ear Polypus Forceps



15-2990
Trölsch (Wilde)
10.5 cm

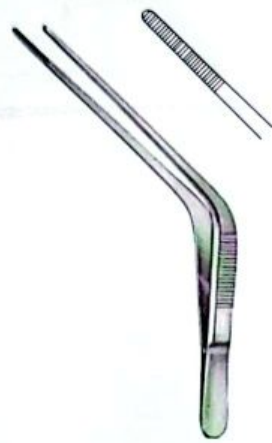

15-2991
Trölsch (Wilde)
11 cm



15-2992
Trölsch (Wilde)
12.5 cm



15-2993
Grünwald
14.5 cm



15-2994
Jansen
16 cm

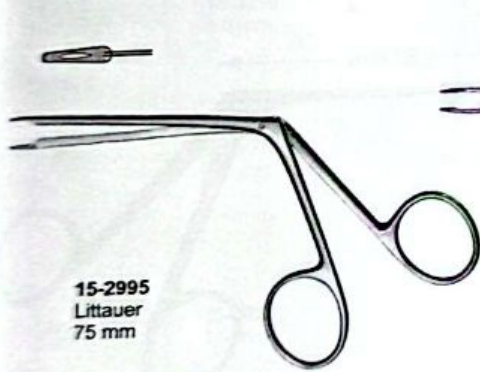

15-2995
Littauer
75 mm

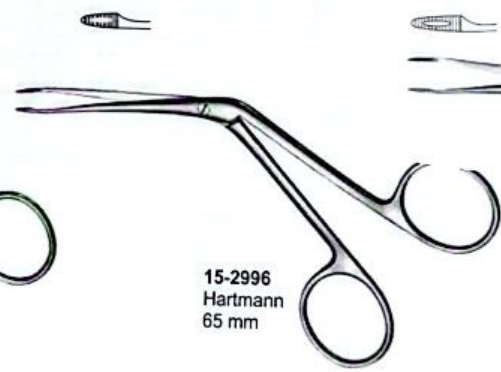

15-2996
Hartmann
65 mm



15-2997
Hartmann
65 mm

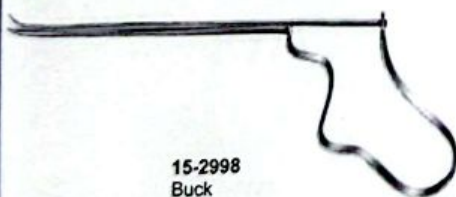

15-2998
Buck
11.5 cm



15-2999
Hartmann-Wullstein
85 mm



15-3000
Hartmann-Wullstein
85 mm
1.0 mm Ø



15-3001
Hartmann
85 mm



15-3002
Hartmann
85 mm

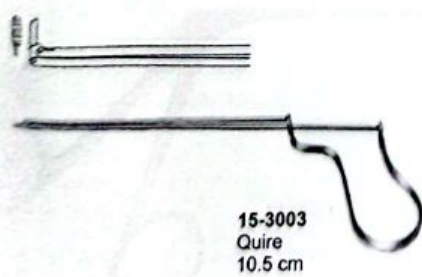

15-3003
Quire
10.5 cm



15-3004



Micro Ear Forceps



15-3005
4.0 x 0.8 mm

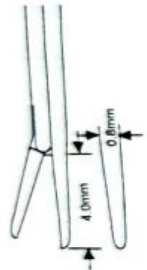

15-3006
4.0 x 0.8 mm



15-3007
4.0 x 0.8 mm



15-3008
4.0 x 0.8 mm



15-3009
4.0 x 0.8 mm



15-3010
3.5 x 0.6 mm

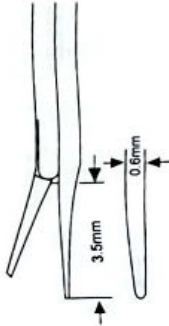

15-3011
3.5 x 0.6 mm

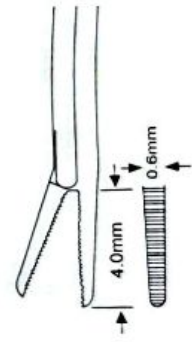
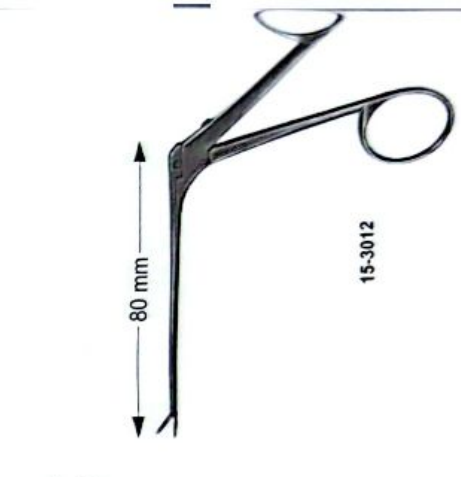

Micro Ear Forceps



15-3013
4.0 x 0.6 mm

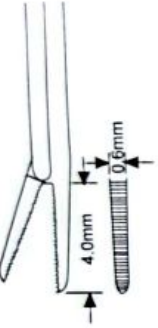
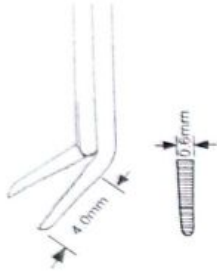

15-3014



15-3015



15-3016



15-3013-15-3016



15-3017
4.0 mm



15-3018
4.0 mm

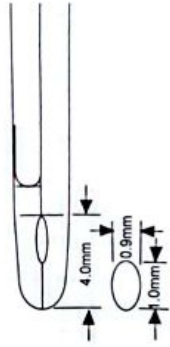

15-3019
4.0 mm



15-3017-15-3020



15-3020
4.0 mm



15-3021
3.5 mm

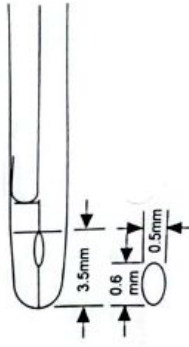

15-3022
3.5 mm



15-3023
3.5 mm



15-3021-15-3024
Mini-McGee



15-3024
3.5 mm



Micro Ear Forceps



15-3025



15-3026

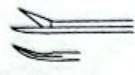

15-3027



15-3028



15-3029



15-3030

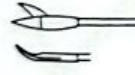

15-3031



15-3032



15-3033
0.8 x 3.5 mm



15-3034
0.8 x 3.5 mm

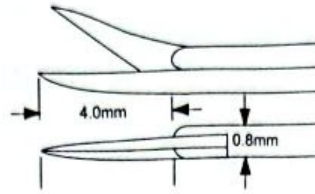

80 mm



15-3025-1511
Belluzi

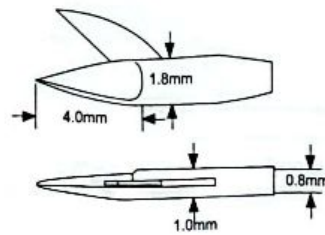

80 mm



15-3029-1511
Wulster

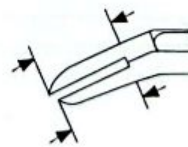

80 mm



15-3033-1511
McCae



Micro Ear Forceps

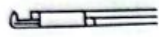

15-3035

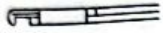
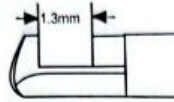

15-3036

80 mm



15-3035-15-3036
House-Dieter

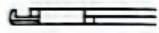

15-3037

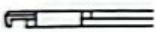
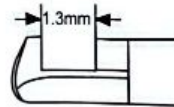

15-3038

80 mm



15-3037-15-3038
House-Dieter



80 mm



15-3039
Fuller



**Micro Ear Hooks, Micro Ear Needles,
Micro Ear Knives, Ear Curettes**

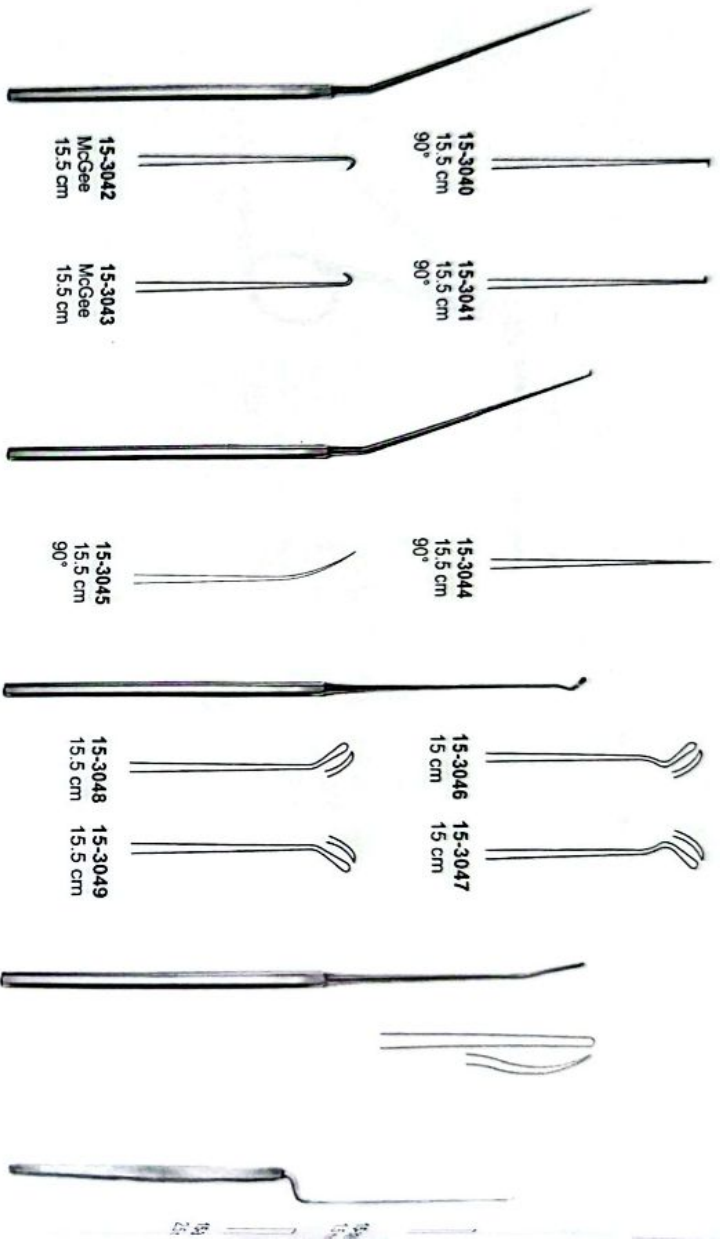

15-3040-15-3043

15-3044-15-3045
Barbara

15-3046-15-3049
Fisch

15-3050
Rosen

15-3051-15-3052
Rosen

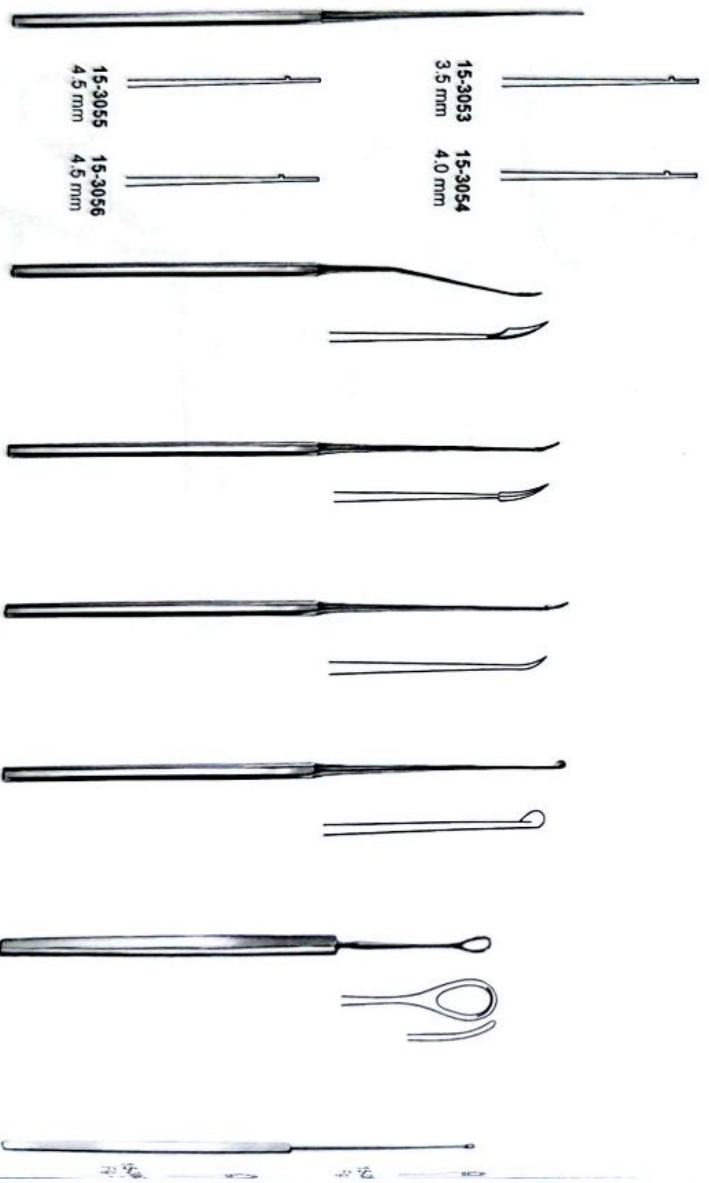

15-3053-15-3056
House

15-3057
Schuknecht
14.5 cm

15-3058
Wulstein
15.5 cm

15-3059
Tabl
15.5 cm

15-3060
Plesler
15 cm

15-3061
Langenbeck
13 cm

15-3062-15-3063
Shaper
19 cm



Ear Currettes, Ear Scoop, Foreign Body Instruments

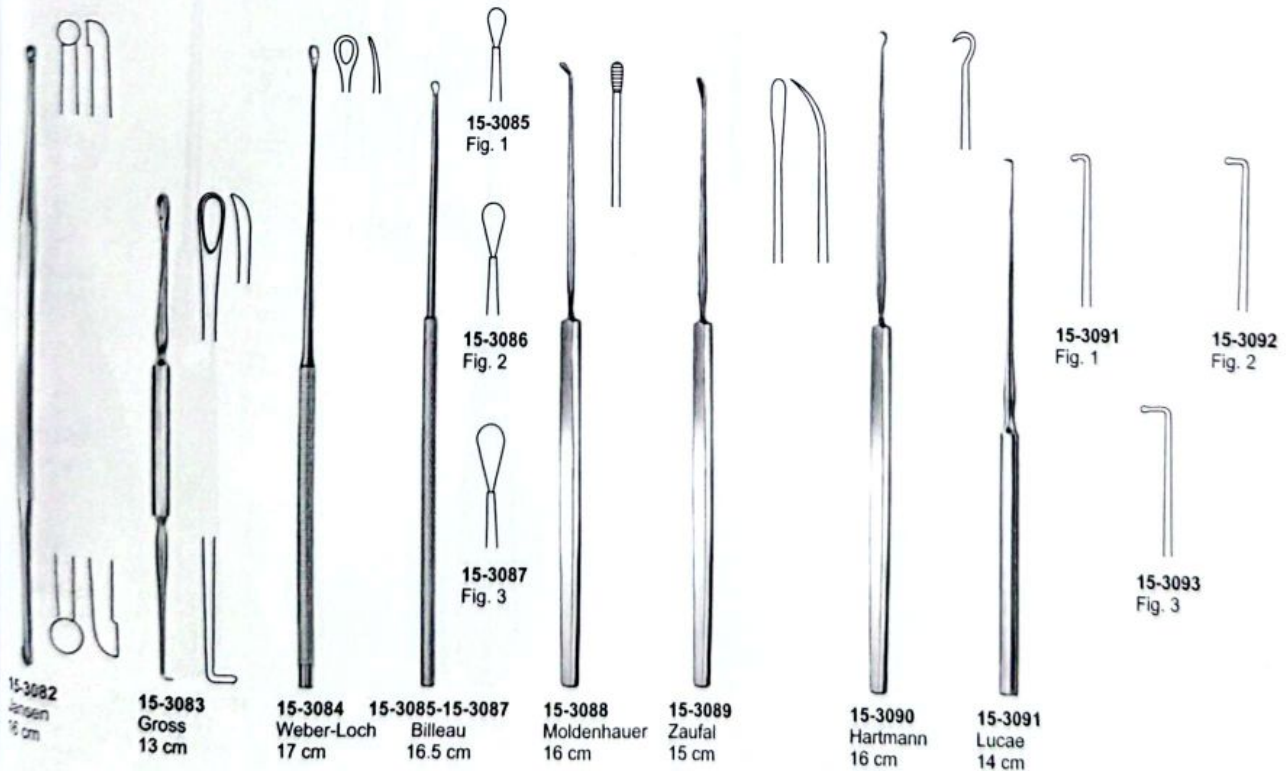
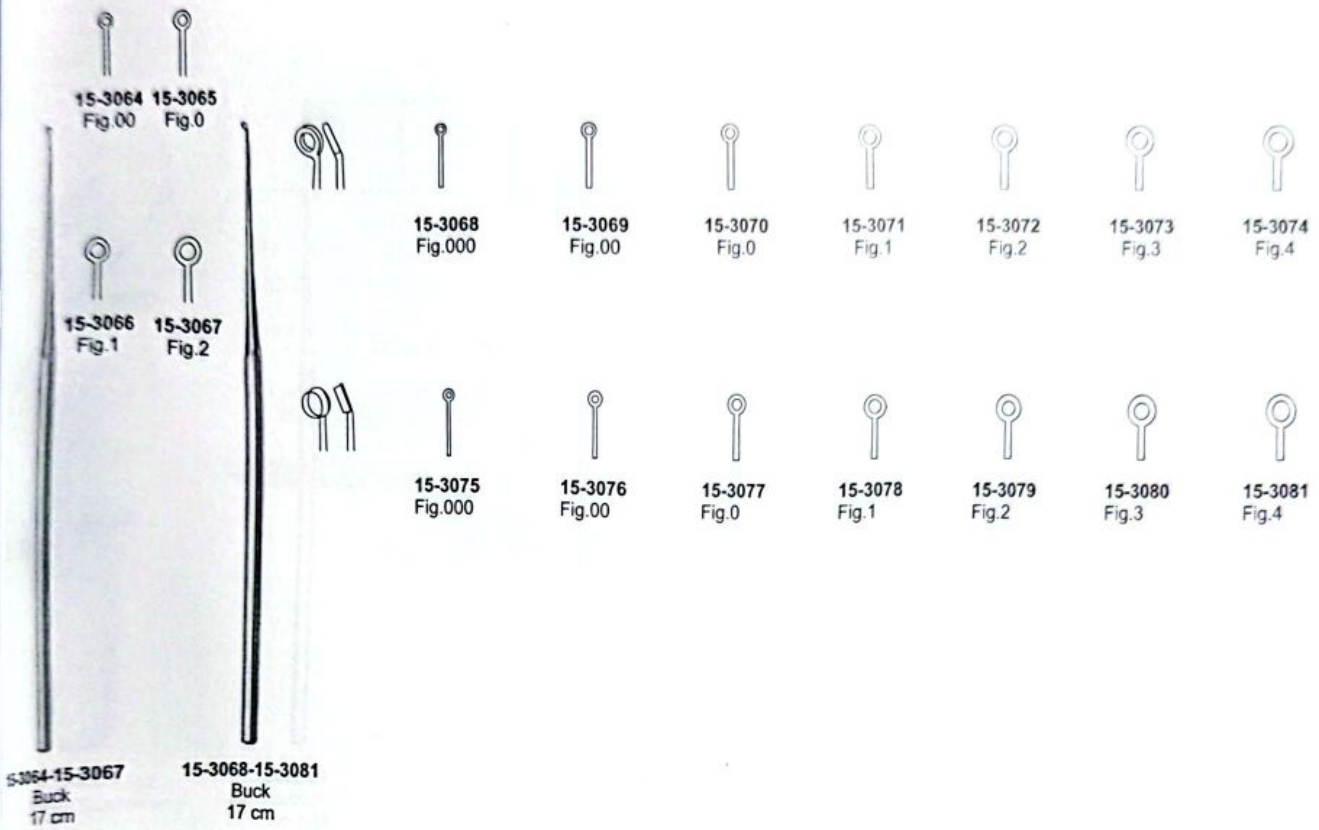

Ear Hooklet, Tympanum Needles, Ear Periosteal Elevators, Ear Scoop



15-3094-15-3100
Wagener
14 cm

15-3101-15-3102
Day
17 cm

15-3103
Politzer
17.5 cm



15-3109
6 mm

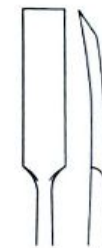

15-3111
6 mm



Nasal Specula



16-3200-16-3202
Bismuth (Thudichum)

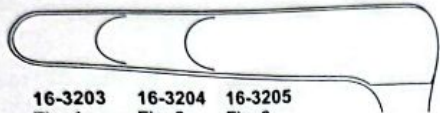

16-3203 Fig. 1 35 mm
16-3204 Fig. 2 50 mm
16-3205 Fig. 3 75 mm

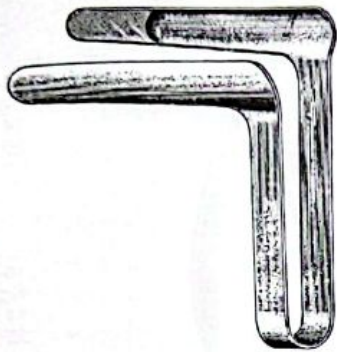

16-3203-16-3205
ST. Clair Thomson



16-3206
Vacher



16-3207-16-3209
Voltolini



16-3210
Hartmann



16-3211
Fig. 1
27 mm



16-3212
Fig. 2
31 mm

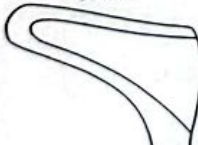

16-3213
Fig. 3
35 mm



16-3211-16-3213
Hartmann-Halle
16 cm



16-3214
Schwarz
14 cm



16-3215
Vienna
14.5 cm



16-3216
Mod. Wien
13.5 cm

16-3216-A
30 mm



Nasal Specula



16-3217
Martin
13 cm



16-3219
Martin
13 cm



16-3221
Tieck-Halle
13 cm



16-3223-16-3226
Killian



16-3224
Fig. 3
16 cm
75 mm



16-3225
Fig. 2
14.5 cm
50 mm



16-3226
Fig. 1
14 cm
35 mm



16-3227-16-3230
Killian
13 cm

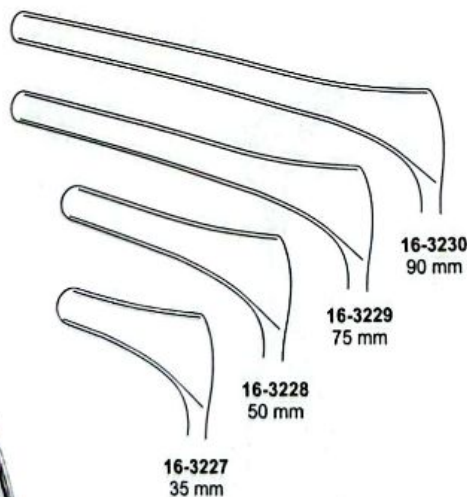

16-3227
35 mm

16-3228
50 mm

16-3229
75 mm

16-3230
90 mm



16-3231-16-3234
Cottle
13 cm

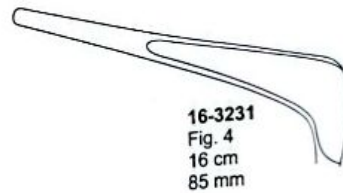

16-3231
Fig. 4
16 cm
85 mm

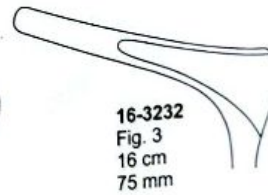

16-3232
Fig. 3
16 cm
75 mm

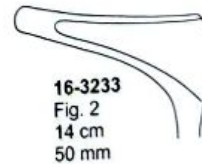

16-3233
Fig. 2
14 cm
50 mm



16-3234
Fig. 1
13.5 cm
35 mm



16-3235
Cottle (with socket)
13 cm



Nasal Specula, Polypus Snares, Septum Compressor
 Compression Forceps

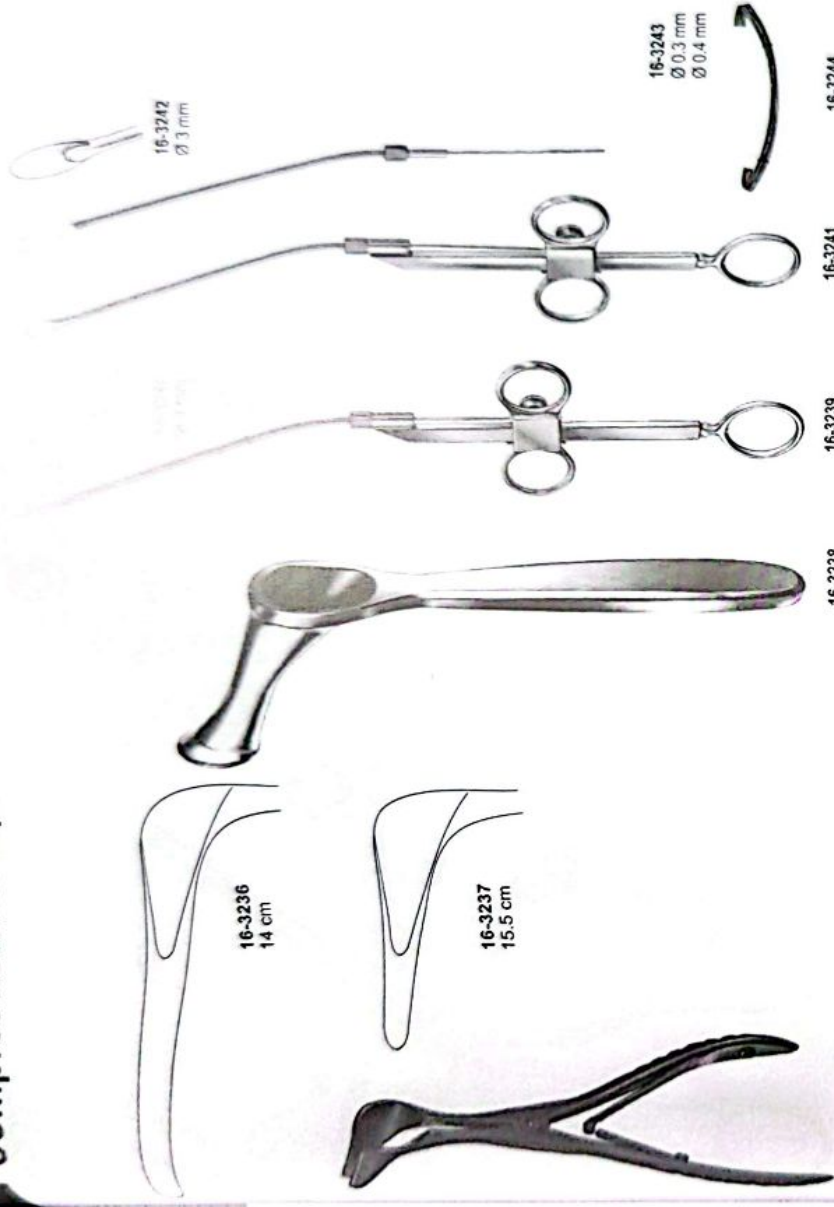

Nasal Polypus and Septum Compression Forceps,

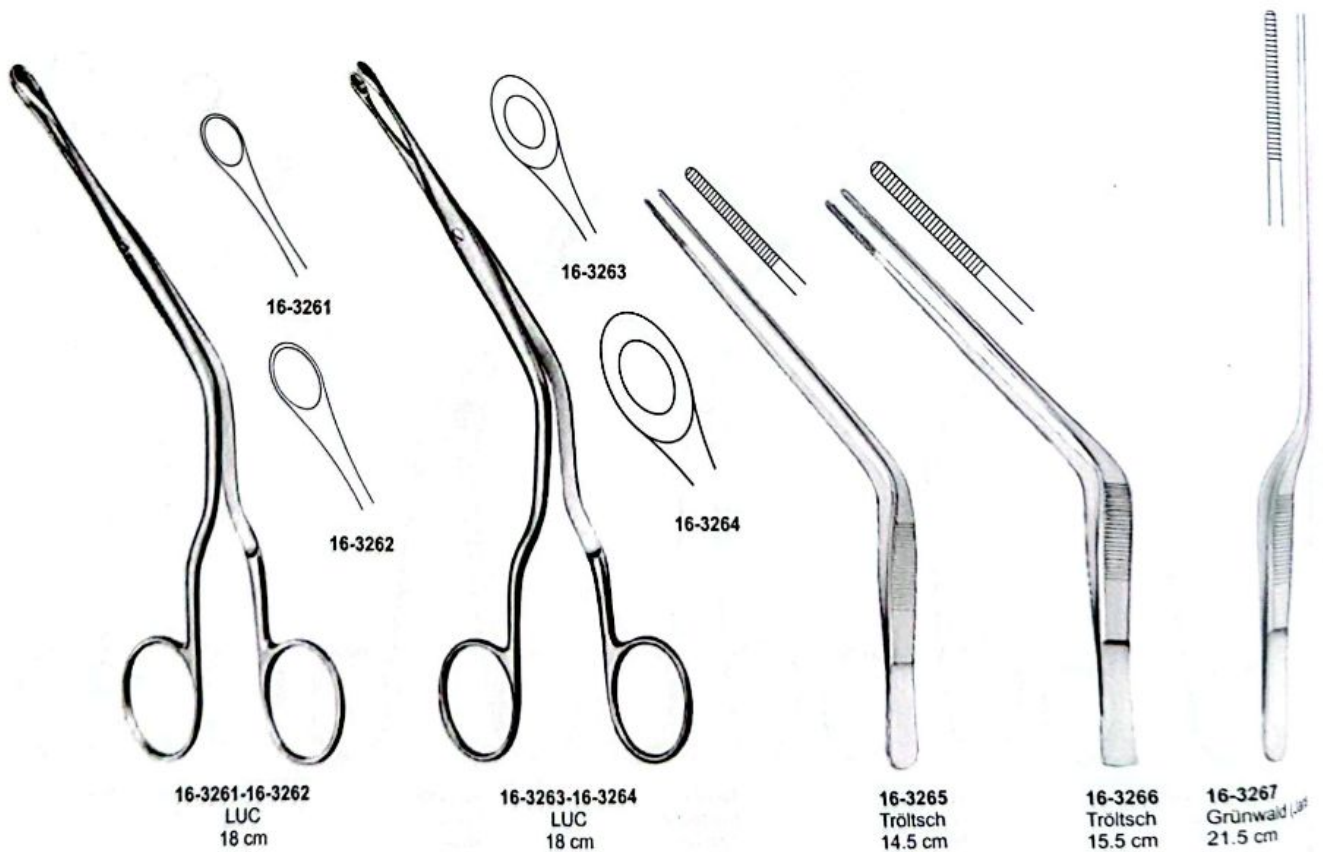
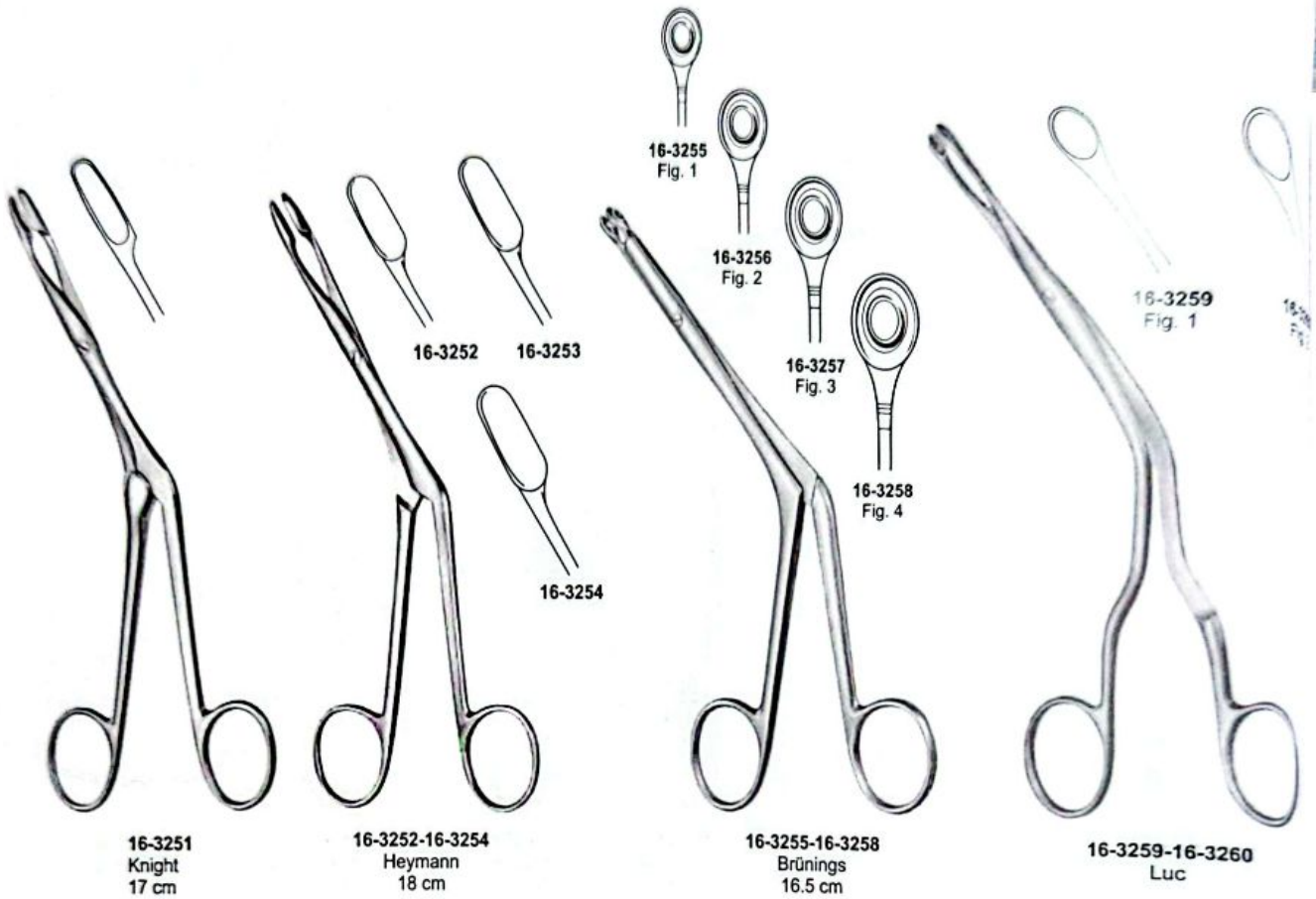

Nasal Polypus and Septum Compression Forceps, Ethmoid Bone Forceps

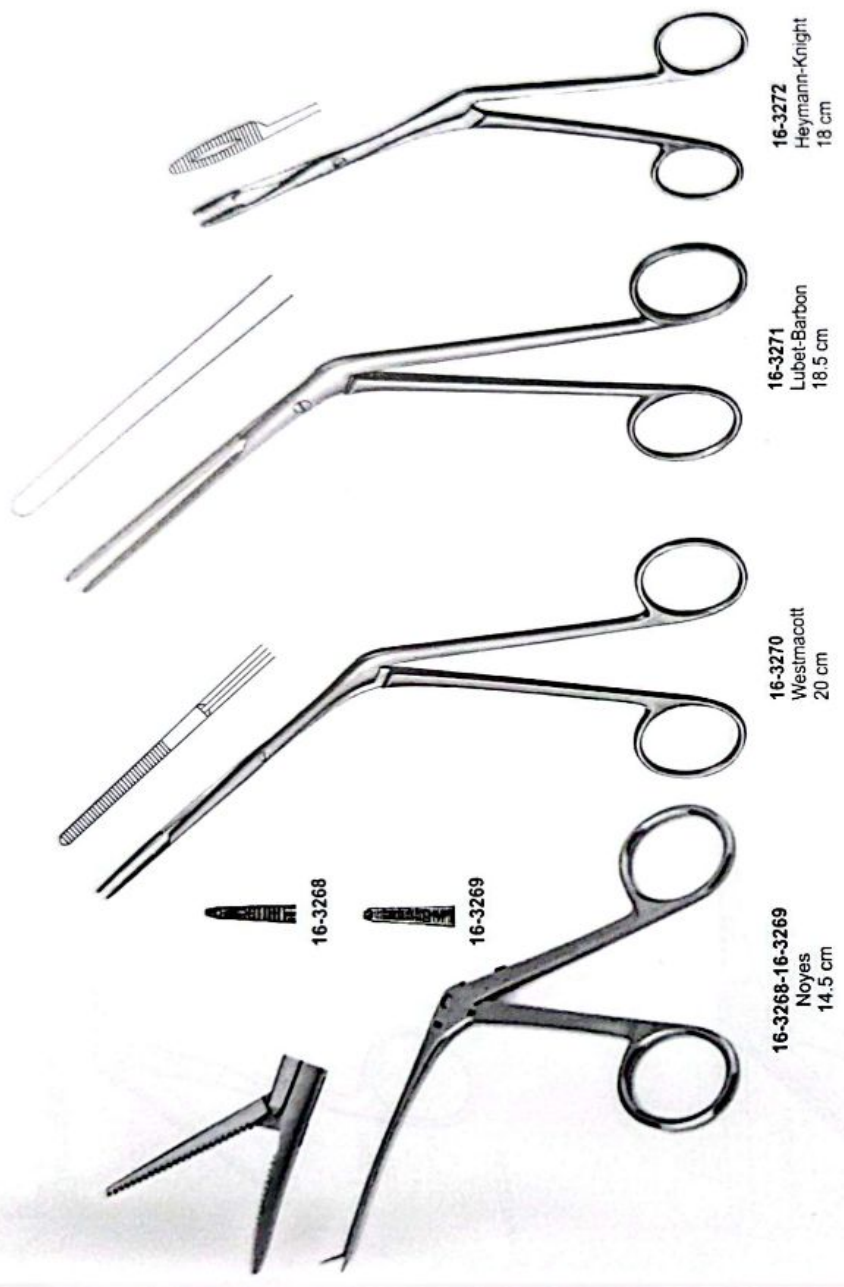

16-3268-16-3269
Noyes
14.5 cm

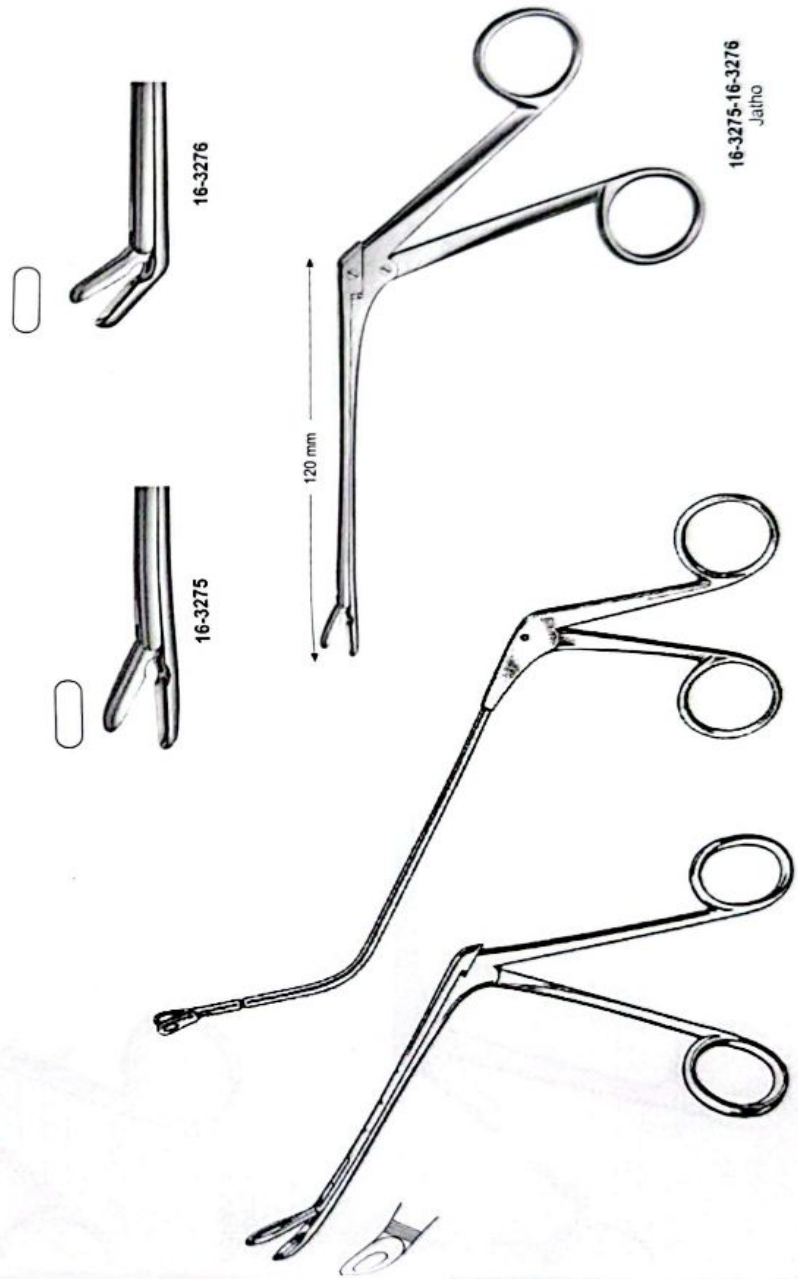

16-3274
Jatho

16-3273
Henckel
20 cm

Ethmoid Bone Forceps



16-3277
Watson-Williams

120 mm



16-3277-16-3278



16-3278



16-3279
Weil



120 mm



16-3280-16-3281
Struyker

16-3280
Fig. 1
0.9 mm

16-3281
Fig. 2
1.2 mm



125 mm



16-3282-16-3283
Weil-Blakeslee



16-3282
Fig. 1
3.0 mm



16-3283
Fig. 2
3.5 mm



16-3284
Fig. 3
4.5 mm



16-3285
Fig. 4
5.5 mm



16-3286
Fig. 5
6.0 mm



Ethmoid Bone Forceps



16-3287
Hajak
19 cm
120 mm



16-3288
Hartmann
19 cm
120 mm



16-3289
Schmedenschmeden
19 cm
120 mm



16-3290
Myles
19 cm
120 mm



16-3287-16-3290

180 mm



16-3291
3.0 x 3.0 mm

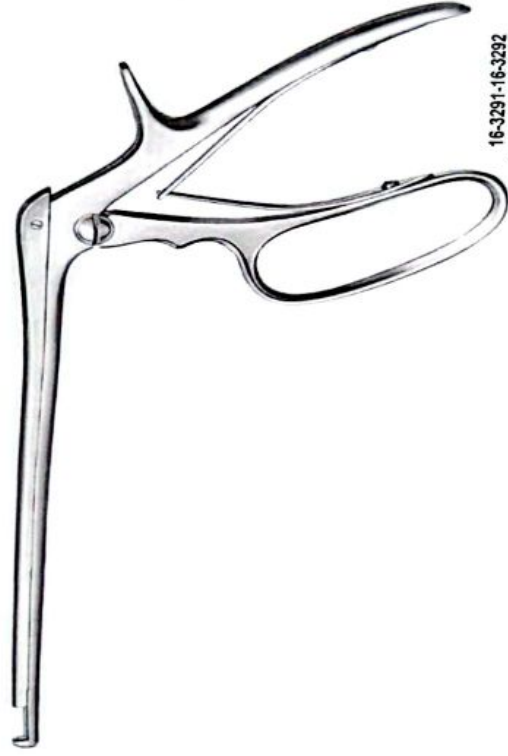

16-3291-16-3292
Ferris-Smith-Karrison



16-3292
3.0 x 3.0 mm

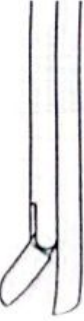

16-3293

180 mm

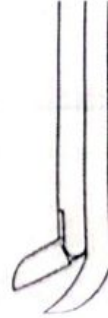

16-3294

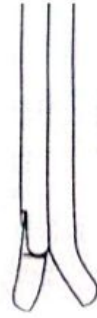

16-3295

16-3293-16-3295

Osteotomes, Chisels

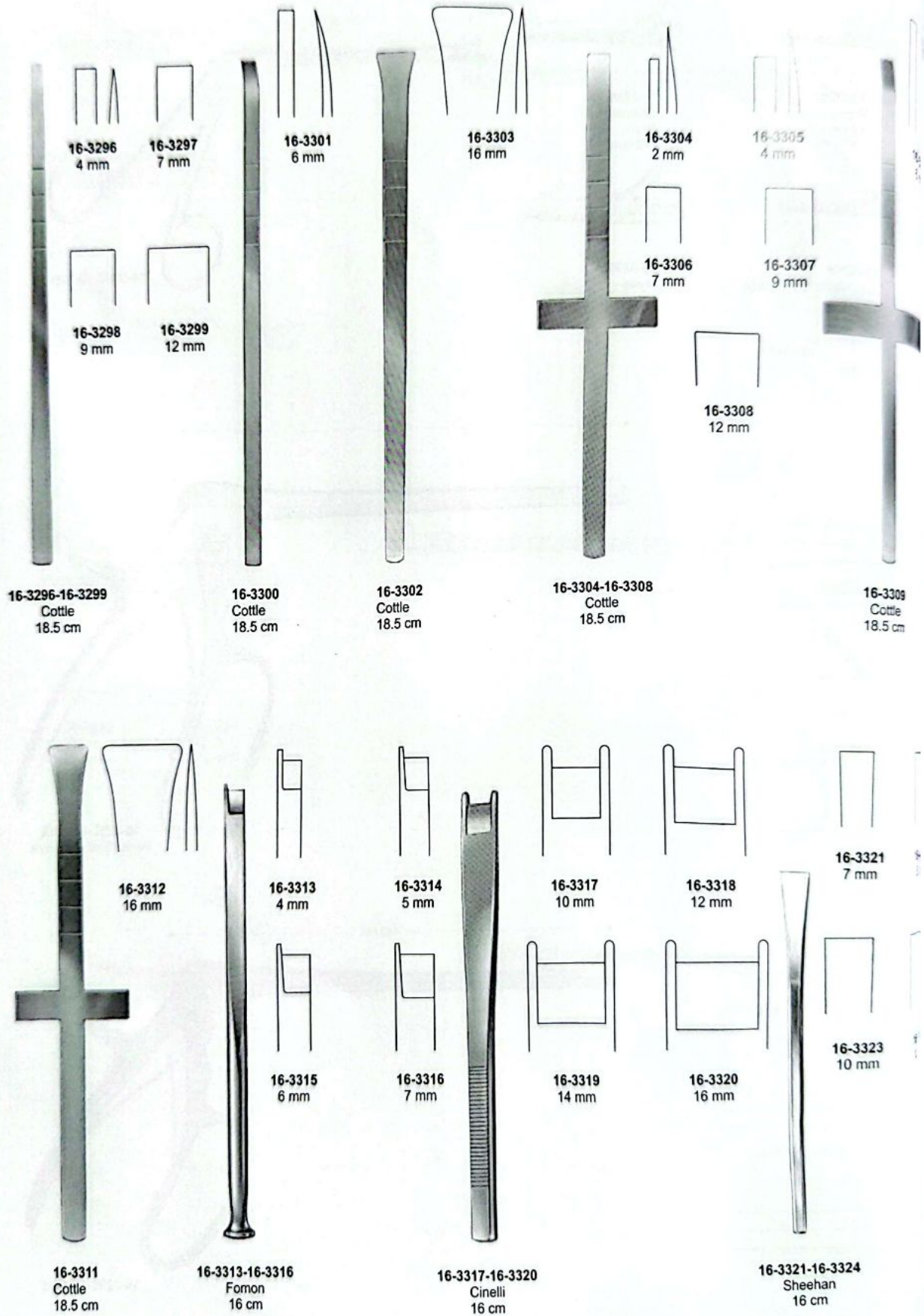

Rhinoplastic Chisels, Chisels, Cartilage Crowner

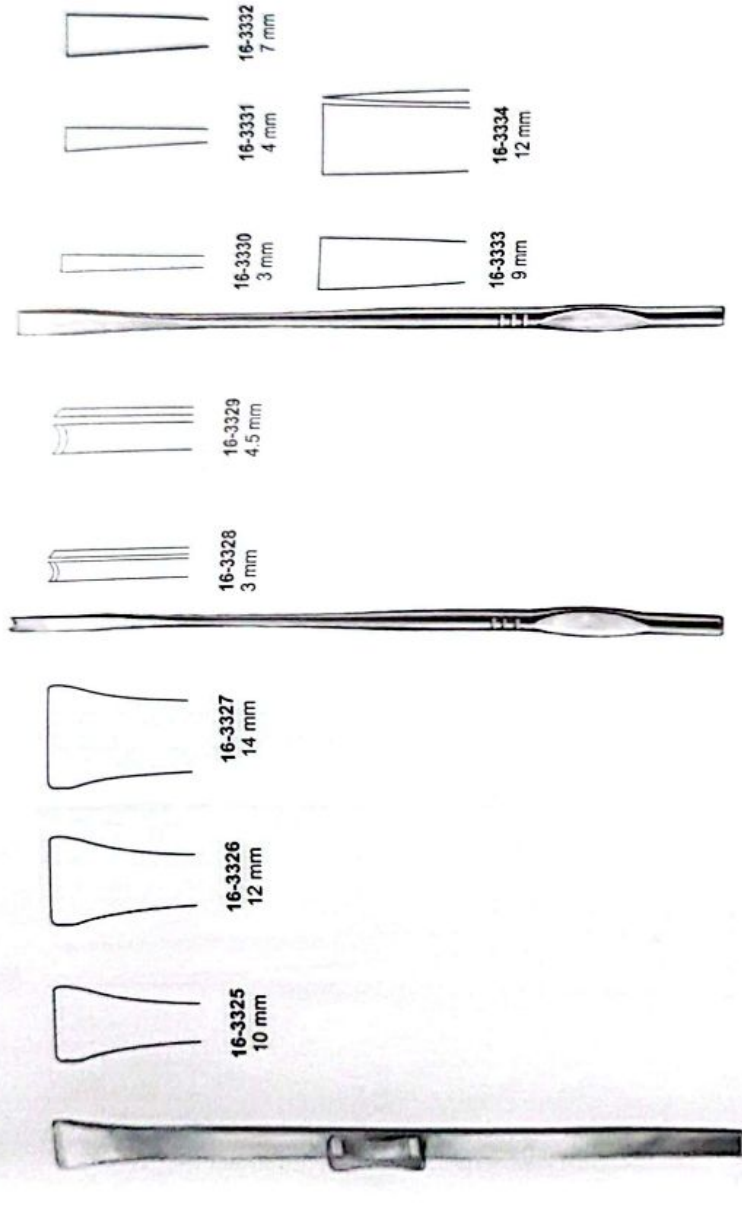

16-3325-16-3327
Rubin
18.5 cm

16-3328-16-3329
Walter
19 cm

16-3330-16-3334
Walter
19 cm



16-3335
Cottle
12 cm

16-3336
Cottle
7 cm

16-3337
Cottle
65 x 30 x 30 mm

Glabella Rasps, Nasal Rasps

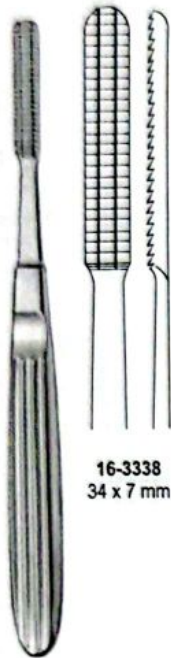

16-3338
34 x 7 mm

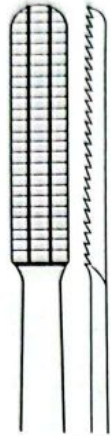

16-3339
34 x 7 mm

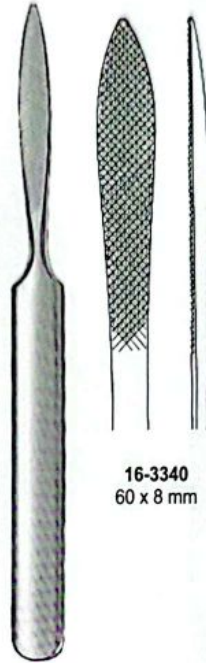

16-3340
60 x 8 mm



16-3341
45 x 9 mm

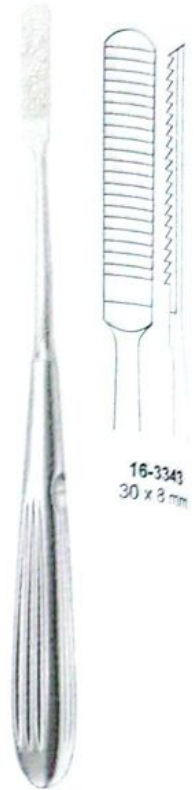

16-3342
30 x 8 mm

16-3338-16-3339
Maltz
17 cm

16-3340-16-3341
Joseph
16 cm

16-3342
Cottle
21 cm

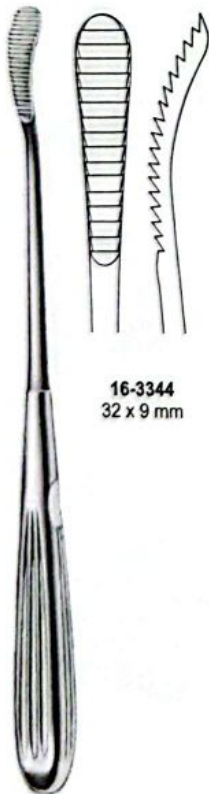

16-3344
32 x 9 mm

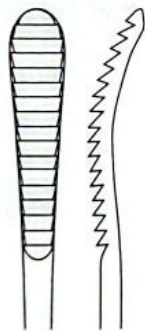

16-3345
32 x 9 mm

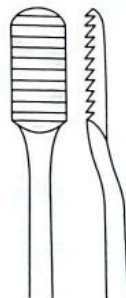

16-3346
15 x 8 mm



16-3347
15 x 8 mm

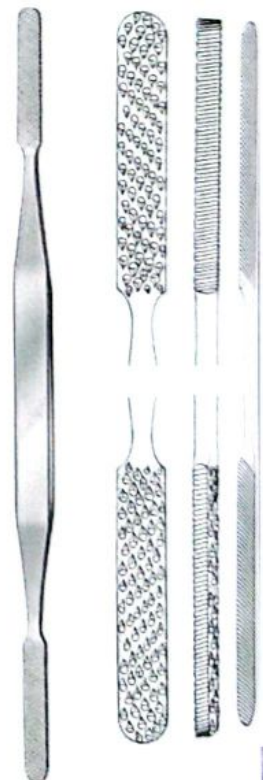

16-3344-16-3345
Aufricht
21 cm

16-3346-16-3347
Lewis
19 cm

16-3348
Fomon
21 cm

Nasal Hooklets, Alar Hooklets, Mucosa Hooklets

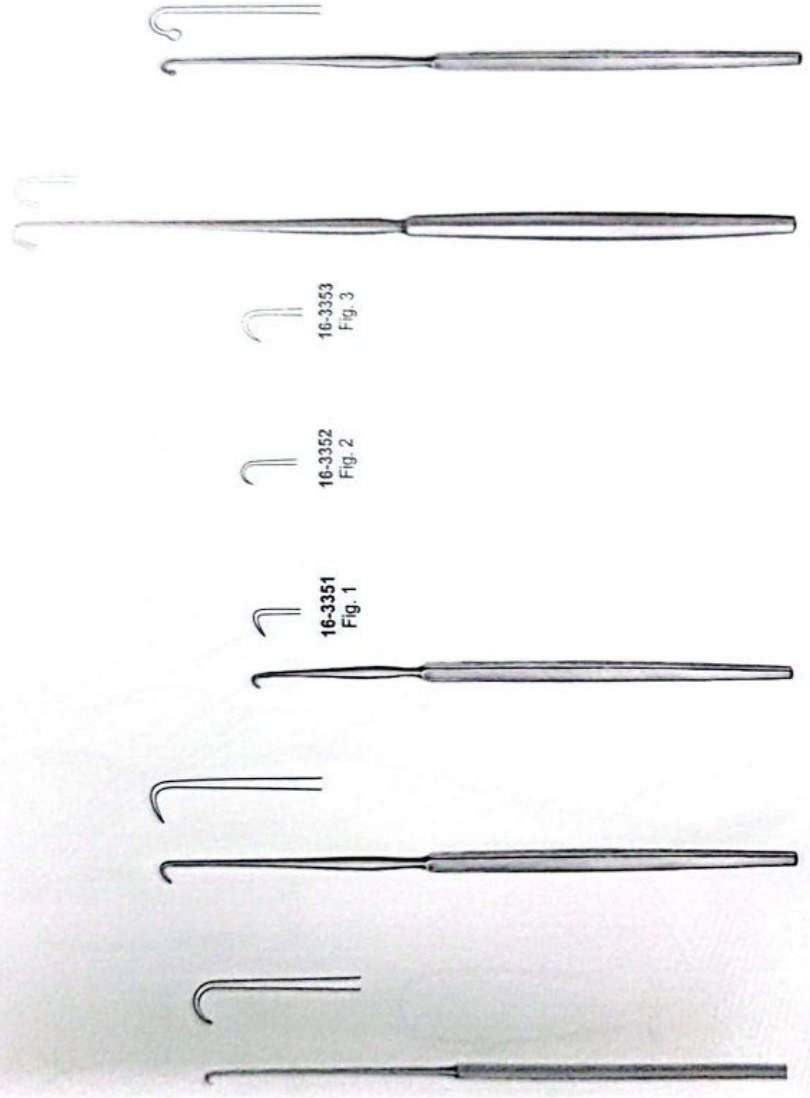

16-3349 Joseph 15.5 cm

16-3350 Cotille 17 cm

16-3351-16-3353 Cotille 14.5 cm

16-3354 Lange

16-3355 Fomon 16 cm

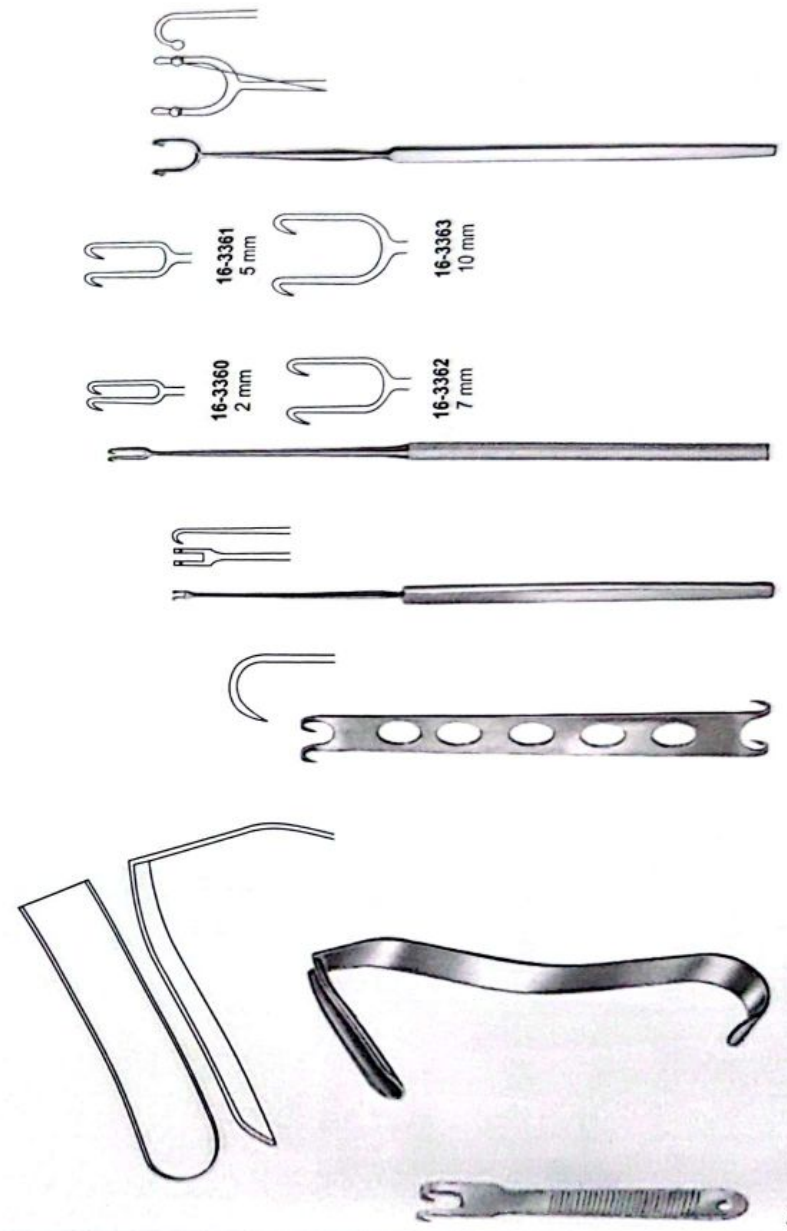

16-3355 Kliner 8 cm

16-3356 Kliner 8 cm

16-3358 Converse 11.5 cm

16-3359 Freer 15 cm

16-3360-16-3363 Joseph 16 cm

16-3364 Fomon 16 cm

Nasal Retractors, Septum Forceps, Septum Straightening Forceps Skin Grasping Forceps



16-3365
Neivert
17 cm



16-3366
Neivert
14 cm



16-3367
Kressner
22 cm



16-3368-16-3370
Cottle-Walsham
23 cm



16-3368



16-3370



16-3370

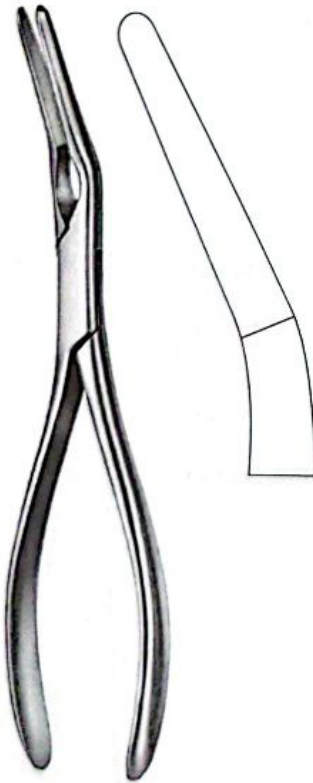

16-3371
Asch
22.5 cm



16-3372
Aiach
15.5 cm



16-3373
Ogura
11 cm



16-3373
4 mm



16-3375
Cottle
11 cm



16-3375
1.7 mm



16-3377
Cottle
11 cm

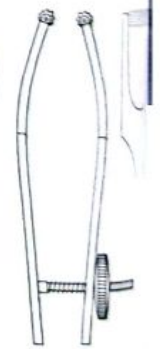

16-3378
12 mm



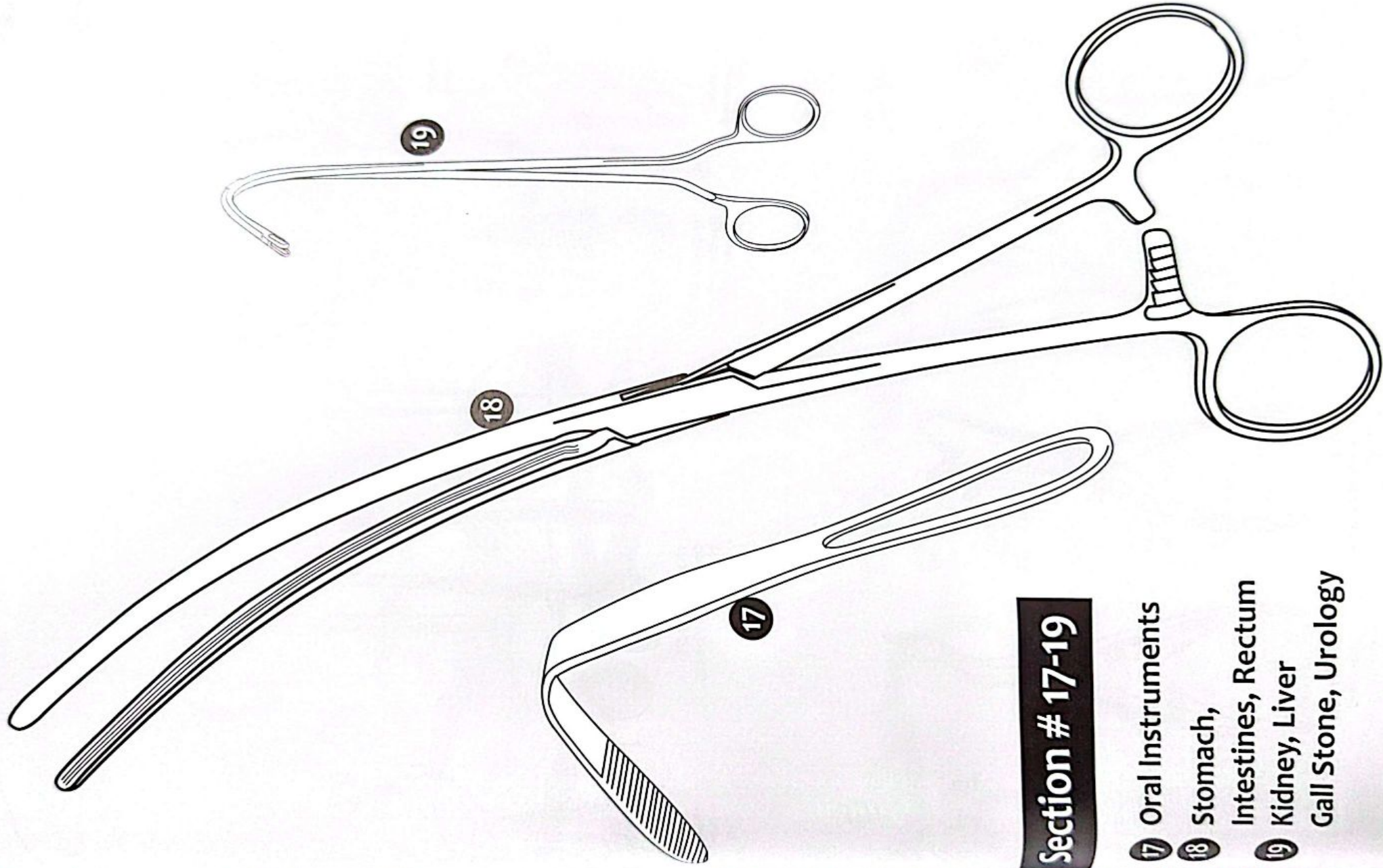

Section # 17-19

- 17 Oral Instruments
- 18 Stomach, Intestines, Rectum
- 19 Kidney, Liver Gall Stone, Urology

Finger Protector, Mouth Gags



17-3401
Adams



17-3402
Pitha
28 x 30 mm



17-3403
Langenbeck
Ø 26 / 20 mm



17-3404
Maunder
9.5 cm



17-3405
Heister
13 cm



17-3406
Obwegeser
11 cm



17-3407
Molt
11 cm



17-3408
Molt
13 cm



17-3409
Denhart
13 cm



17-3410
FERGUSON-ACKLAND
Mouth gag
Size: 145 mm



17-3411-17-3412
Roser-König



Mouth Gags

Oral Instruments



17-3413
Killner-Doughity



17-3414
Fig. 1
68 x 30 mm



17-3415
Fig. 2
77 x 34 mm



17-3416
Fig. 3
82 x 39 mm



17-3414-17-3416
Killner-Doughity
14.5 cm

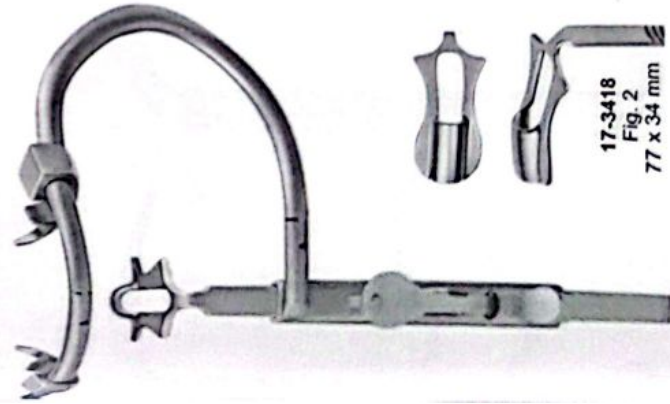

17-3417-17-3419
Killner-Doughity
14.5 cm



17-3417
Fig. 1
68 x 30 mm



17-3418
Fig. 2
77 x 34 mm



17-3420
Fig. 1



17-3421
Fig. 2



17-3420-17-3422
Neukam

Mouth Gags



17-3423
Davis-Boyle



17-3424-17-3427
Fig. 1
110 x 28 mm



17-3424
Fig. 2
95 x 27 mm

17-3424
Fig. 3
80 x 27 mm



17-3426
Fig. 4
65 x 26 mm



17-3427
Fig. 5
30 x 20 mm



17-3428
McIvor

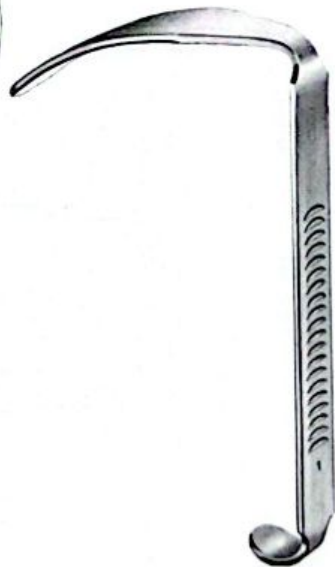

17-3429
Fig. 1
100 x 25 mm



17-3430
Fig. 2
85 x 25 mm



17-3431
Fig. 3
75 x 25 mm



Mouth Gags, Lip and Cheek Retractors

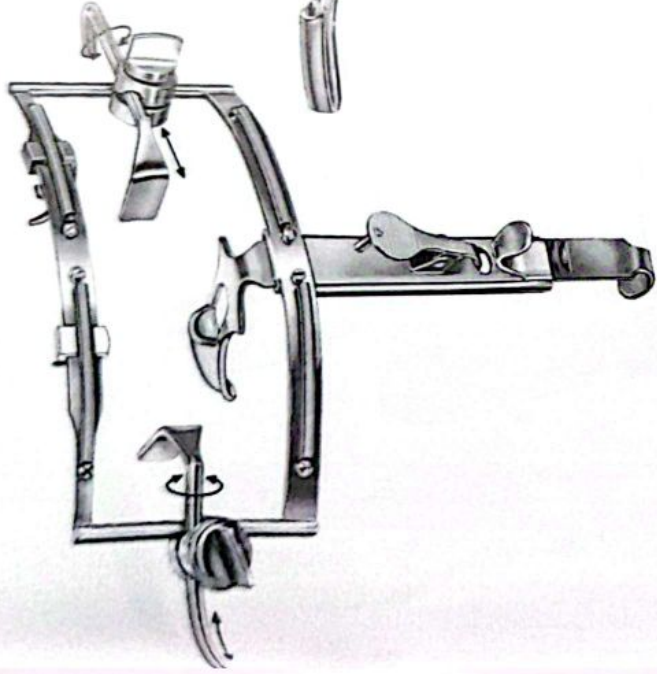

17-3432
Dingmann



17-3433
Fig. 1
62 x 26 mm

17-3434
Fig. 2
65 x 30 mm

17-3435
Fig. 3
78 x 32 mm



17-3436
Jennings
10.5 cm, 12.5 cm
14.5 cm, 16.5 cm

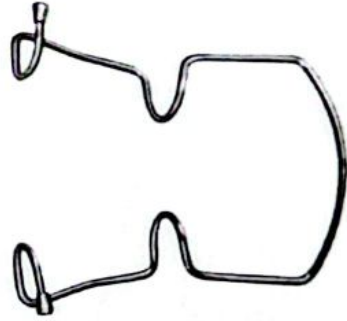

17-3437-17-3439
Oringer

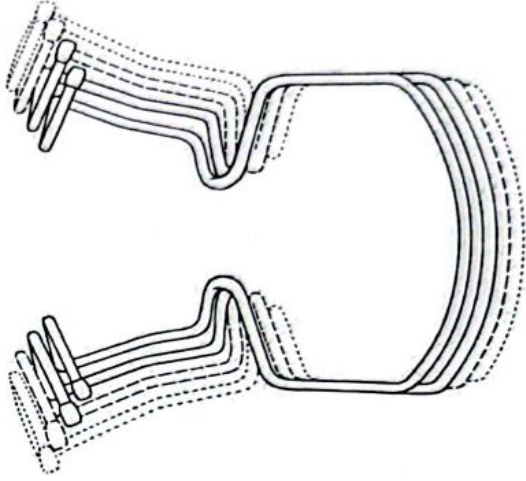

17-3437
Fig. 1
10 cm

17-3438
Fig. 2
10.5 cm

17-3439
Fig. 3
11 cm

Lip and Cheek Retractors, Tongue Depressors



17-3440
Martin-Simplex
10.5 cm



17-3441
14 cm



17-3443
Obwegeser
12 cm



17-3444
Bishop
13.5 cm



17-3445
Cawood-Minnesota
15.5 cm



17-3447
Cawood-Minnesota
14.5 cm

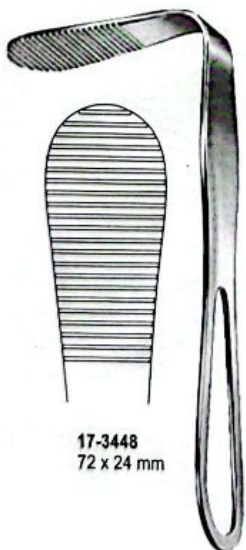

17-3448
72 x 24 mm

17-3449
Hartmann
15 cm



17-3450
83 x 25 mm

17-3451
Tobold
15 cm

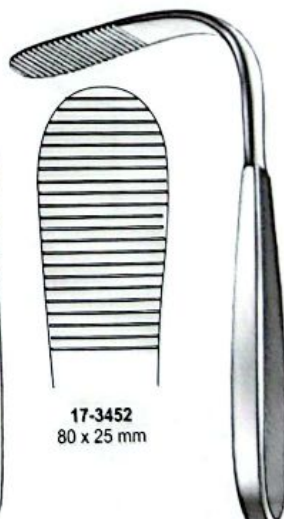

17-3452
80 x 25 mm

17-3453
Tobold
16 cm



17-3454
15 cm
43 mm

17-3455
14 cm
36 mm

17-3456
Wear

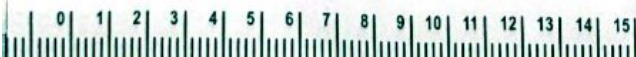

Tongue Spatulas, Tongue Holding Forceps



17-3462
Brünings
19 cm

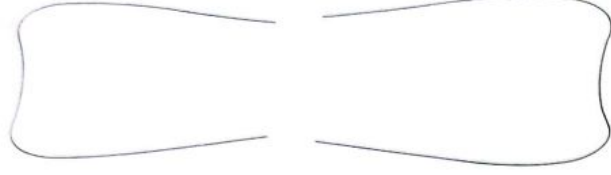

17-3461
16 cm
30 x 33 mm

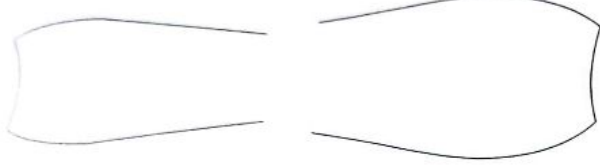

17-3460
13 cm
23 x 30 mm



17-3459
Doyen



17-3458
FRENZEL
Size: 165 mm



17-3457
15 cm



17-3456
15 cm

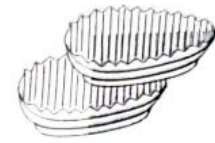

Young

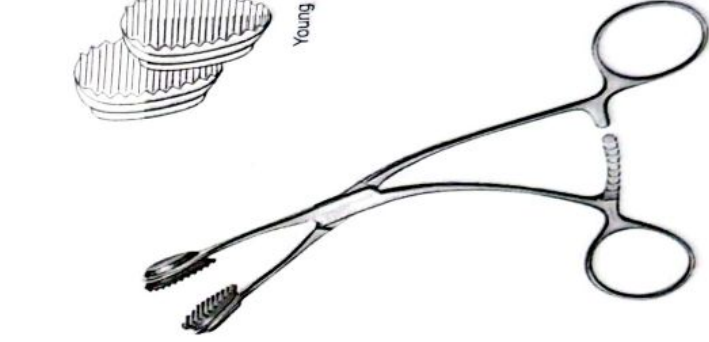

17-3466
Young
15 cm

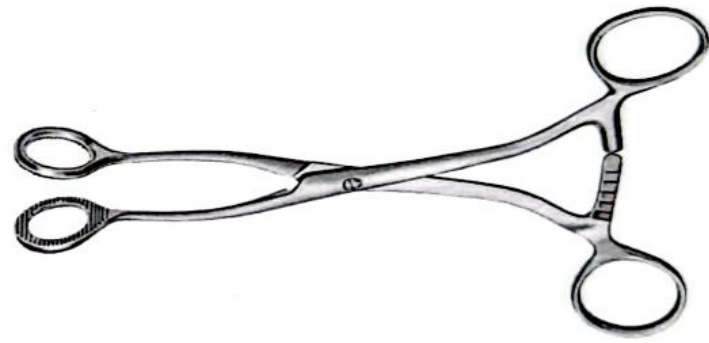

17-3465
Collin
17 cm



19 mm



23 mm



17-3463
14.5 cm

17-3464
14 cm

Extra Oral Retractors



17-3467
22 cm

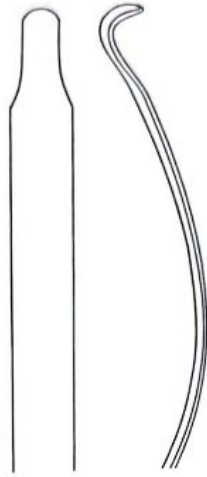

17-3468
Eckelt
21 cm



17-3469
25 cm



17-3470
Eckelt
25 cm



17-3471
23 cm
25.5 mm



17-3472
26 cm
25.5 mm



17-3473
21 cm



17-3474
21 cm

26.5 / 16 mm



17-3475
24.5 cm



17-3476
24.5 cm

26.5 / 16 mm



Intra Oral Retractors, Soft Tissue Retractors

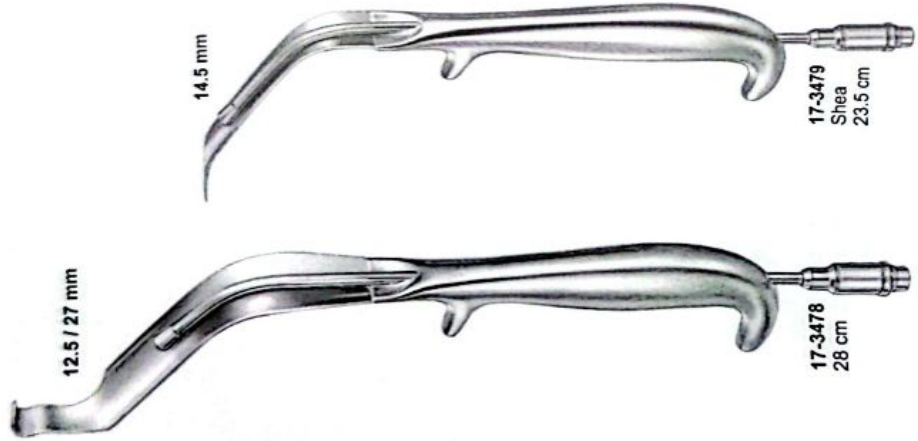

12.5 / 27 mm

14.5 mm

17-3479
Shea
23.5 cm

17-3478
28 cm

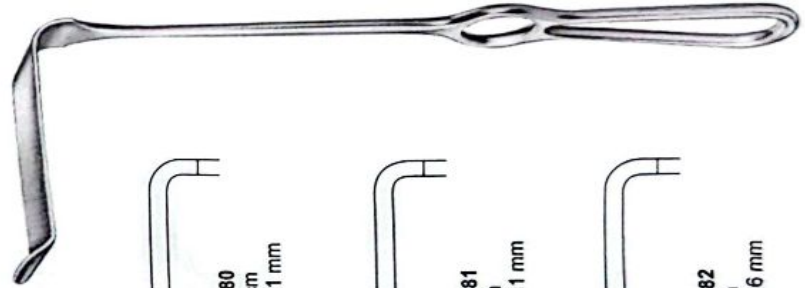

17-3480
22.5 cm
43 x 11 mm

17-3481
23 cm
57 x 11 mm

17-3482
23 cm
80 x 16 mm

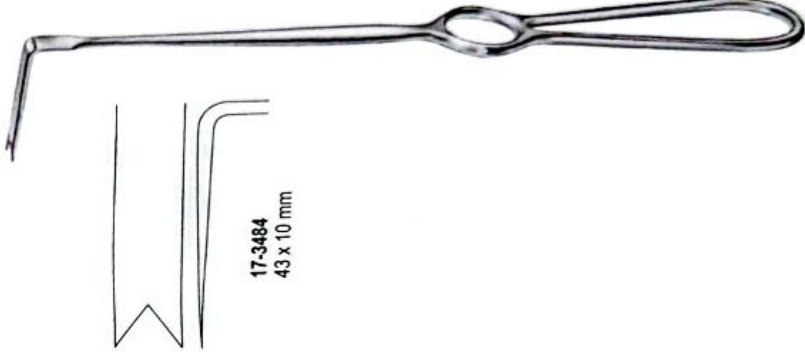

17-3484
43 x 10 mm

17-3480-17-3482
Obwegeser

17-3483
Obwegeser
22 cm

Ramus Retractors, Chin Retractor, Channel Retractors

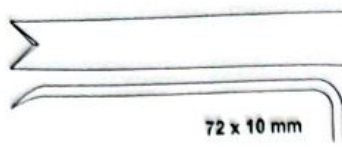

17-3485
Obwegeser
22 cm



17-3486
Obwegeser
16.5 cm



17-3487
Obwegeser
16 cm
8 mm

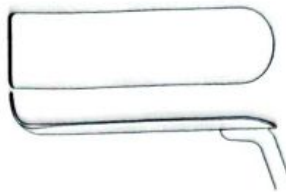

17-3488
Schuchardt
18 cm



17-3489
Metz
19.5 cm

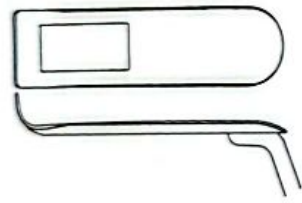

17-3490
Schuchardt-Lauer
15 cm

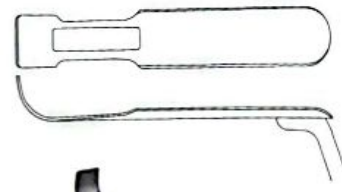

17-3491
Metz-Lauer
15 cm

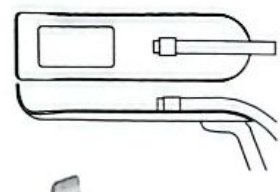

17-3492
Schuchardt-Lauer
15 cm



17-3493
Metz-Lauer
15 cm



Progeny Retractor, Periosteal Elevator

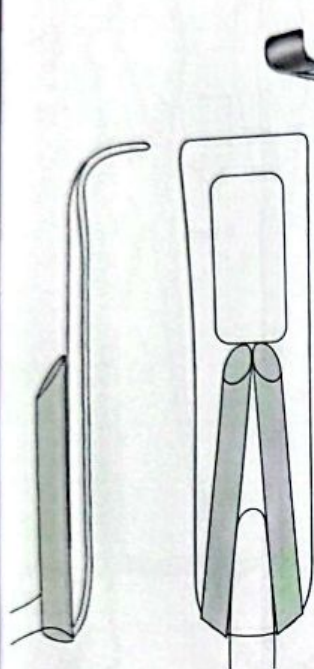

17-3494
Schuchardt-Lauer
20 cm

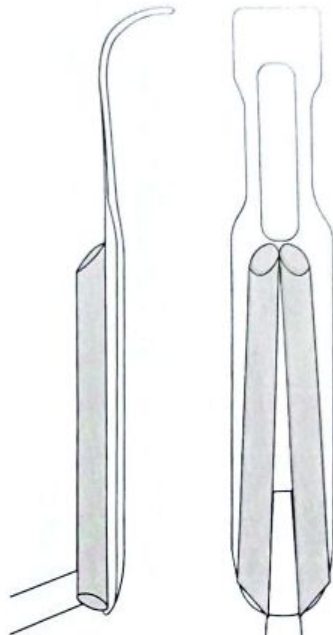

17-3495
Metz-Lauer
20 cm



17-3496
6 mm



17-3497
7 mm



17-3498
9 mm



17-3499
11 mm



17-3500
5 mm



17-3501
7 mm



17-3502
9 mm



17-3500-17-3502
Obwegeser
20 cm

17-3496-17-3499
Obwegeser
17.5 cm



Periosteal Elevators, Elevators, Osteotomes, Wire Pushers

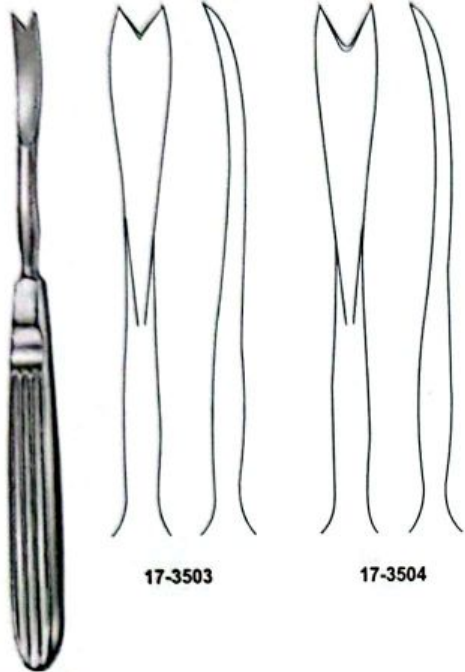

17-3503

17-3504

17-3503-17-3504
Obwegeser
17.5 cm



17-3505
Obwegeser
20.5 cm



17-3506
Obwegeser
20.5 cm

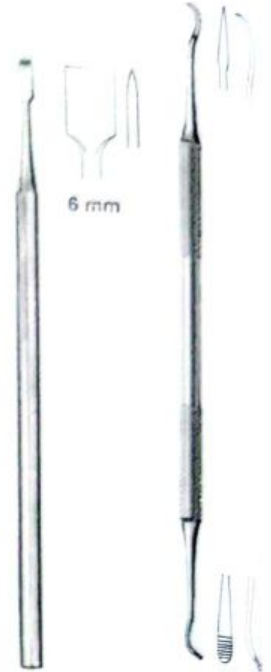

17-3507
Obwegeser
15 cm

17-3508
17 cm



17-3509-17-3511
Rowe
L

17-3512-17-3514
Rowe
R

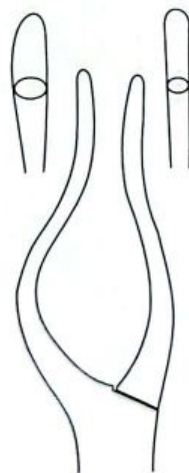

17-3509
L
17-3512
R
21.5 cm

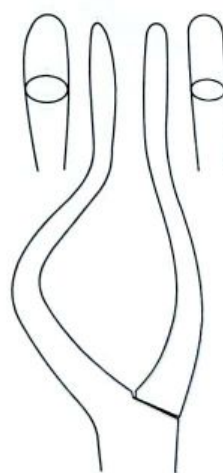

17-3510
L
17-3513
R
24 cm

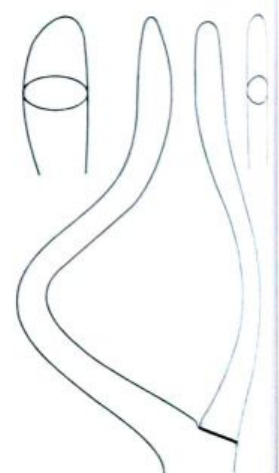

17-3511
L
17-3514
R
24.5 cm



Retractors, Bone Holding Forceps, Instruments for TMJ

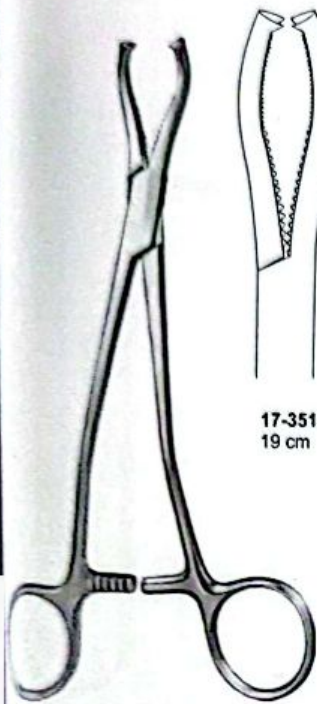

17-3515
19 cm

17-3515-17-3516
Jeter-Van Sickels

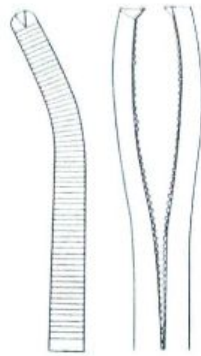

17-3516
18 cm



17-3517

17-3518

17-3517-17-3518
Keen
17.5 cm

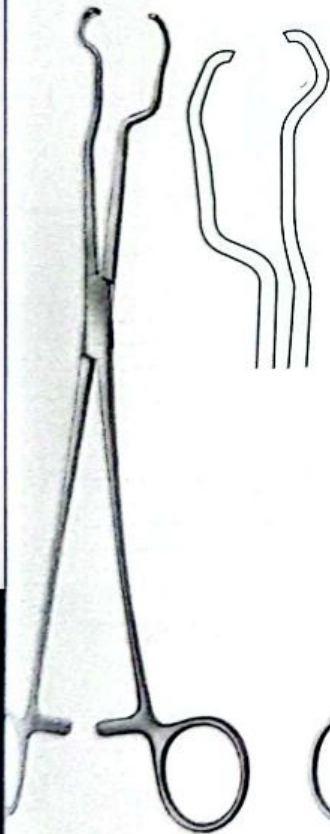

17-3519
Wairford
25 cm



17-3520
Salyer
16.5 cm



17-3521
Dolwick
16 cm

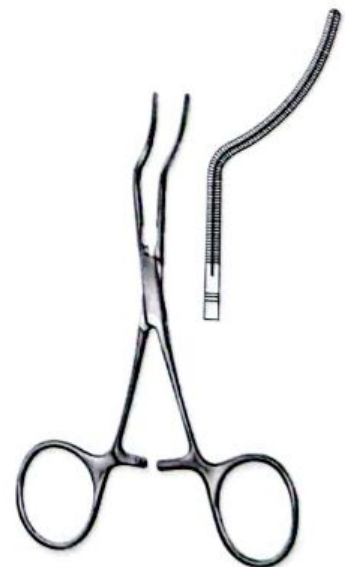

17-3522
Dolwick
12.5 cm



Instruments for TMJ

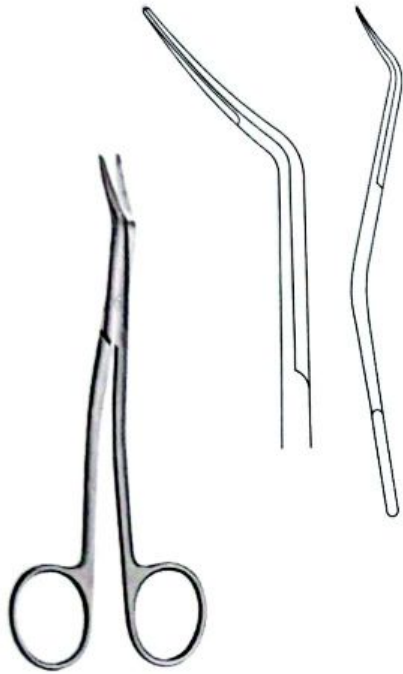

17-3523
Dolwick
13.5 cm



17-3524
Dolwick
14.5 cm



17-3525
Dolwick
17 cm



17-3526
Dolwick
14.5 cm



17-3527
Dolwick
22 cm



17-3528
Champy
16 cm

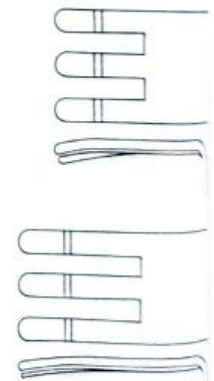
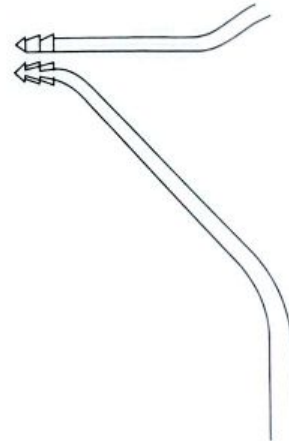

Osteotomes

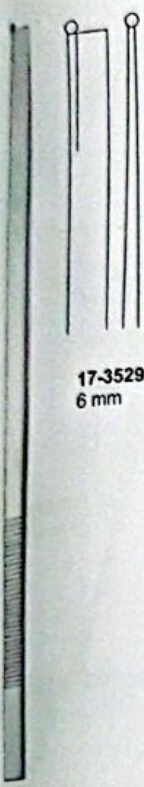

17-3529
6 mm

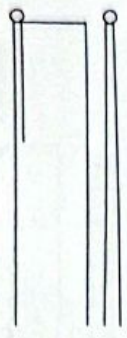

17-3530
8 mm



17-3531
6 mm



17-3532
8 mm



17-3533
Epker-Bauer
17.5 cm



17-3534
8 mm



17-3535
6 mm

17-3529-17-3530
Bauer
17.5 cm

17-3531-17-3532
Bauer
20.5 cm

17-3534-17-3535
Dunn-Dautrey
17 cm



17-3536
4 mm

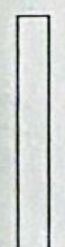

17-3537
6 mm

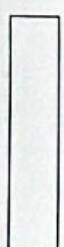

17-3538
8 mm

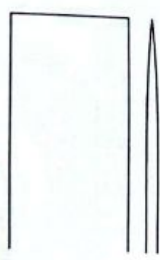
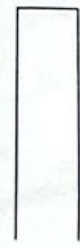

17-3542
16 mm

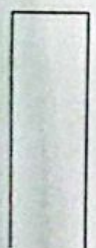

17-3539
10 mm

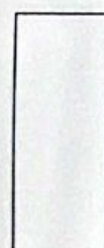

17-3540
12 mm

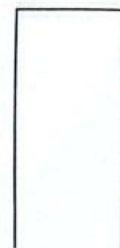

17-3541
14 mm



17-3543-17-3545
Dunn-Dautrey
16 cm



17-3543
4 mm



17-3545
6 mm



17-3544
8 mm



17-3546
Partsch
14.5 cm

4 mm

17-3536-17-3542
Dunn-Dautrey-Munro
17 cm

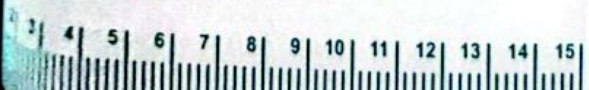

Osteotomes, Periform Rim Retractor, Pterygoid Osteotome, Bone Holding Forceps



17-3547
4 mm



17-3548
6 mm



17-3549
8 mm

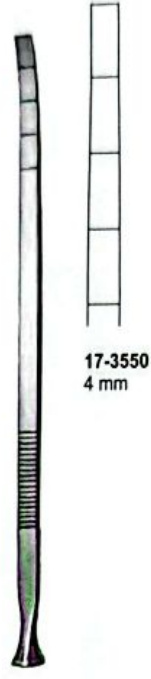

17-3550
4 mm

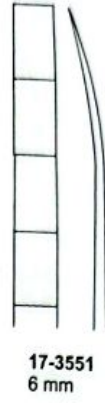

17-3551
6 mm



17-3552
6 mm



17-3553
8 mm

17-3547-17-3549
Epker
18 cm

17-3550-17-3551
Epker
18 cm

17-3552-17-3553
Epker
18 cm

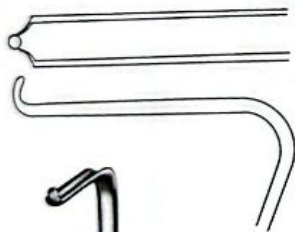

17-3554
Hargis
18.5 cm

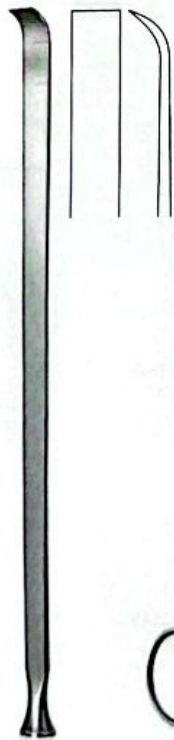

17-3555
Hargis
22 cm

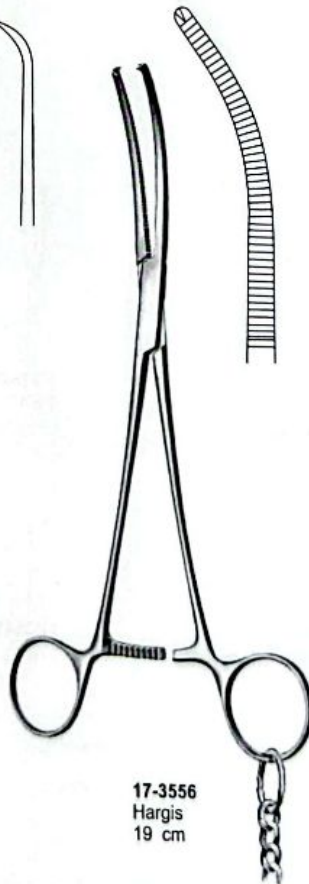

17-3556
Hargis
19 cm



9 mm



17-3557
55 cm



17-3558
Smith
18.5 cm



9 mm



17-3559
Smith
18.5 cm



Osteotomes, Periform Rim Retractor, Pterygoid Osteotome, Bone Holding Forceps

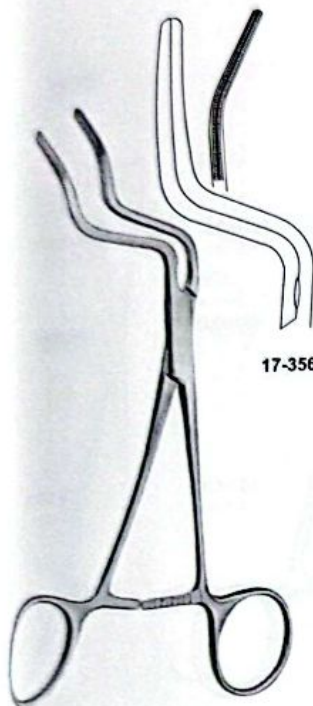

17-3561

17-3560
Terry
17 cm

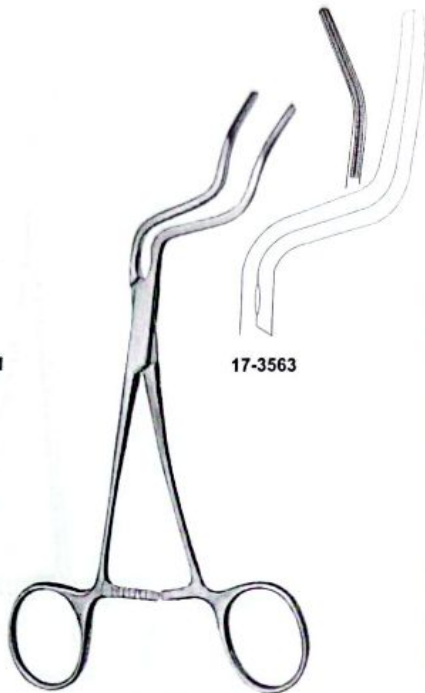

17-3563

17-3562
Terry
17 cm



17-3564
Terry
16.5 cm

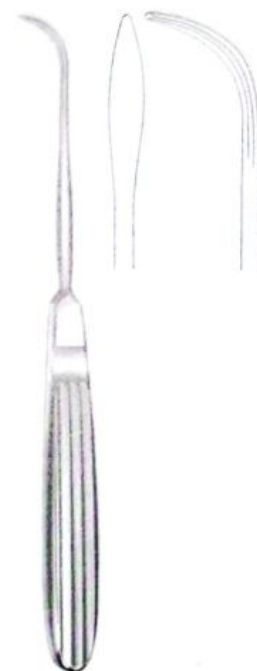

17-3565
Steinhäuser
18.5 cm

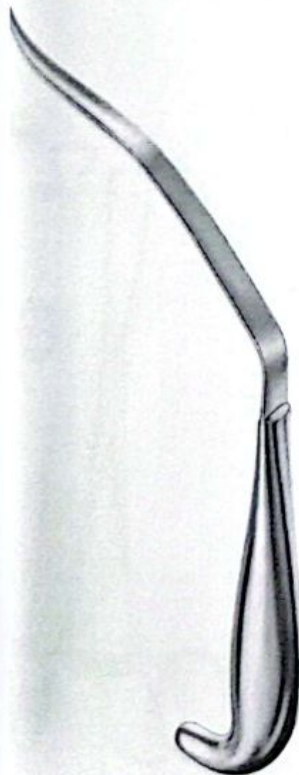

17-3566
Steinhäuser
27 cm



17-3567
Steinhäuser
16 cm

17-3568
Steinhäuser
16 cm



17-3569



17-3570



Intestinal and Tissue Grasping Forceps

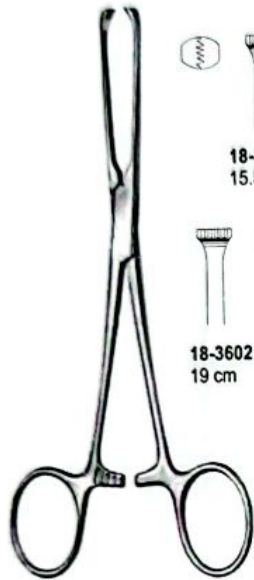

18-3600-18-3603
Allis

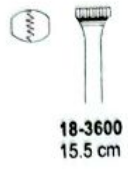

18-3600
15.5 cm

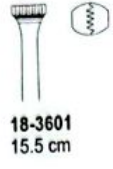

18-3601
15.5 cm



18-3602
19 cm

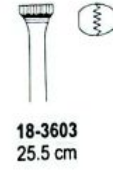

18-3603
25.5 cm



18-3604
Allis-Baby
13 cm



18-3605-18-3608
Allis



18-3605
13.5 cm



18-3607
24.5 cm



18-3606
20 cm



18-3608
30 cm



18-3609
Allis
20 cm



5.6



18-3610
Thoms-Allis
20.5 cm



6.7



18-3611-18-3612
Judd-Allis

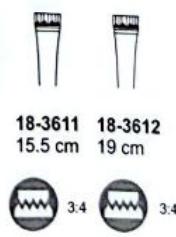

18-3611
15.5 cm

18-3612
19 cm

3.4

3.4



18-3613
Boys-Allis
15.5 cm

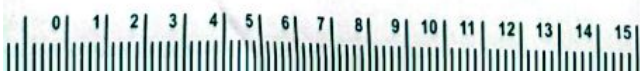

Intestinal and Tissue Grasping Forceps

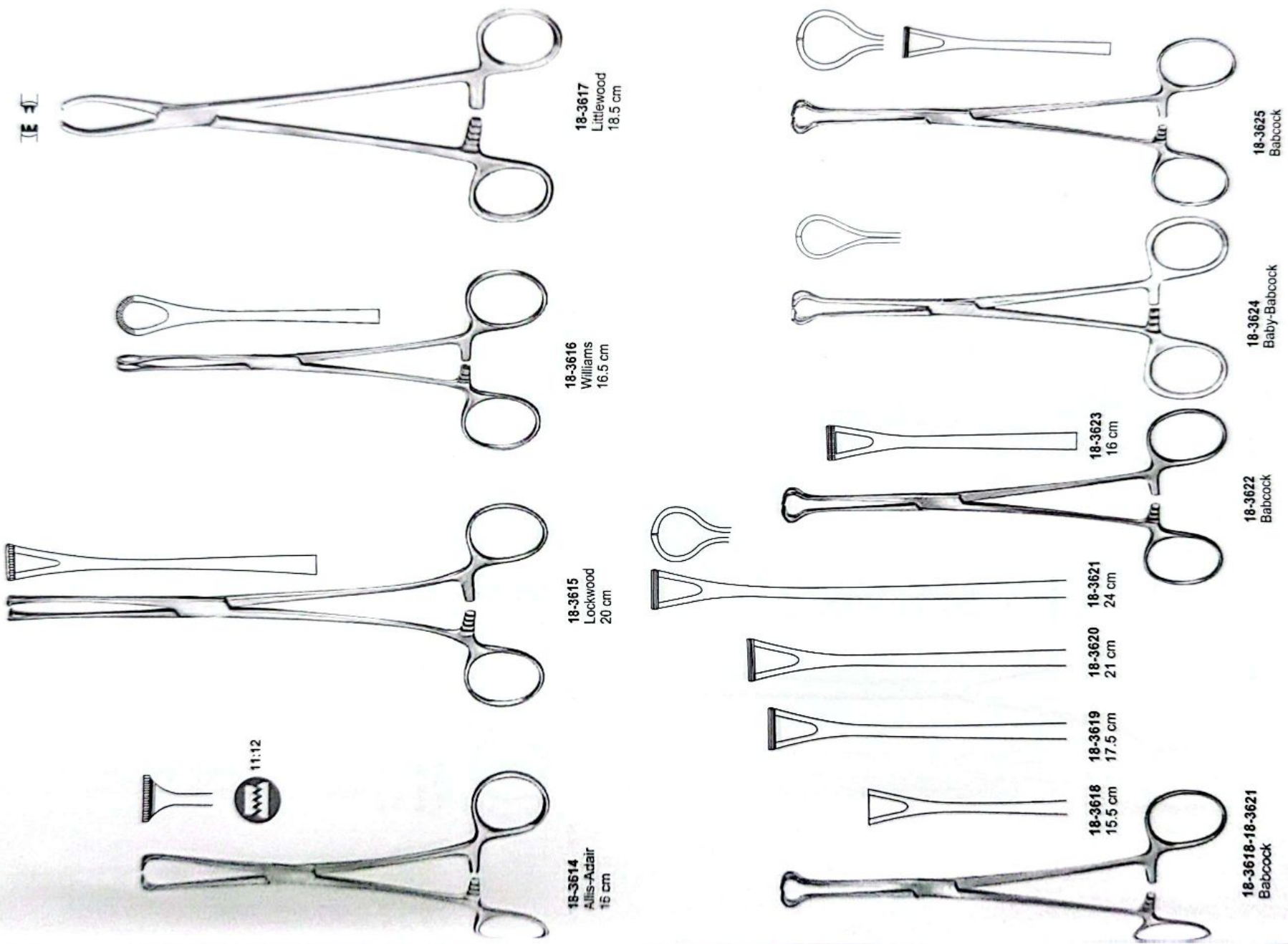

TE 1

11:12

18-3617
Littlewood
18.5 cm

18-3616
Williams
16.5 cm

18-3615
Lockwood
20 cm

18-3614
Allis-Aclair
16 cm

18-3623
16 cm

18-3621
24 cm

18-3620
21 cm

18-3619
17.5 cm

18-3618
15.5 cm

18-3625
Babcock

18-3624
Baby-Babcock

18-3622
Babcock

18-3618-18-3621
Babcock

Intestinal and Tissue Grasping Forceps



18-3627
21 cm

18-3626

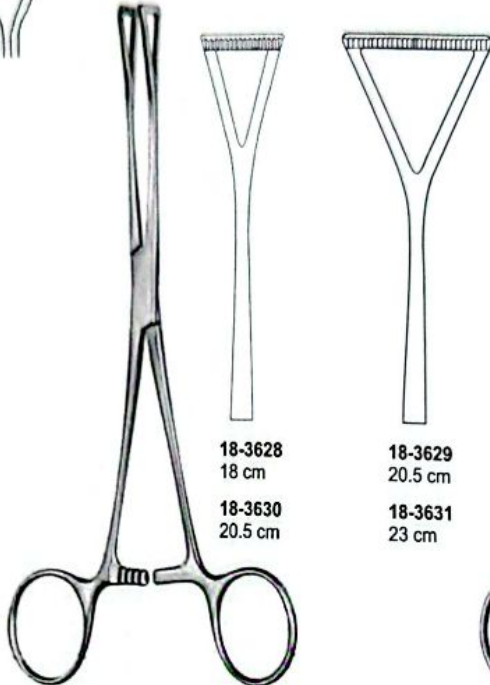

18-3628
18 cm
18-3630
20.5 cm

18-3628-18-3631
Duval



18-3629
20.5 cm
18-3631
23 cm

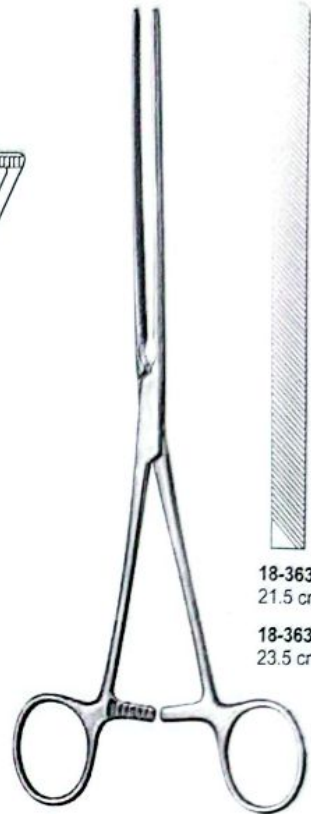

18-3632
21.5 cm
18-3634
23.5 cm

18-3632-18-3635
Doyen

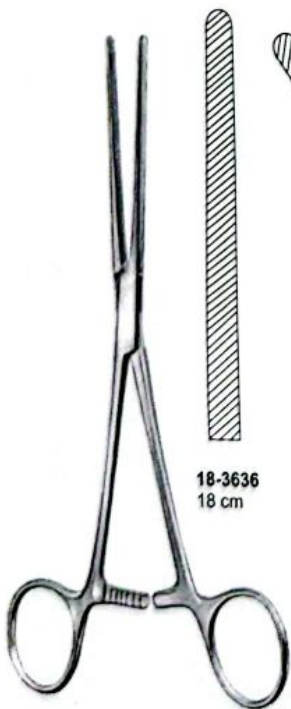

18-3636
18 cm

18-3636-18-3637
Doyen-Baby

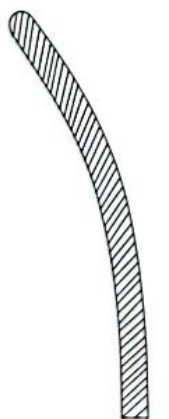

18-3637
17.5 cm

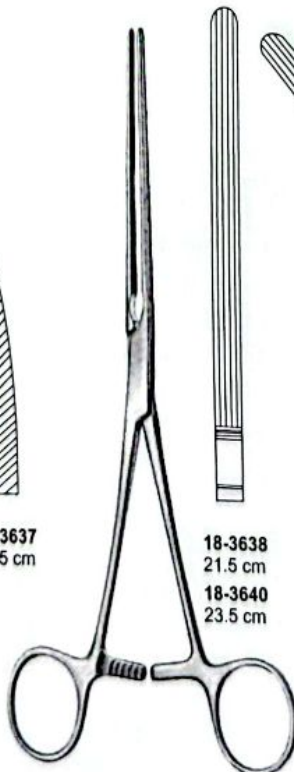

18-3638
21.5 cm
18-3640
23.5 cm

18-3638-18-3641
Mayo-Robson



18-3639
21 cm
18-3641
23 cm

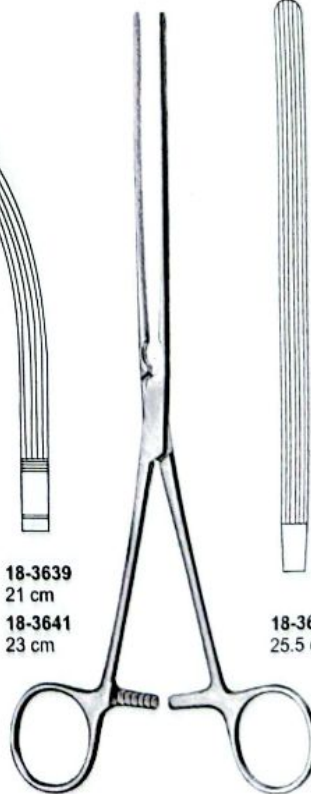

18-3642
25.5 cm

18-3642-18-3643
Mayo-Robson



Intestinal and Tissue Grasping Forceps,
Pylorus Clamps Intestinal Anastomosis Clamps

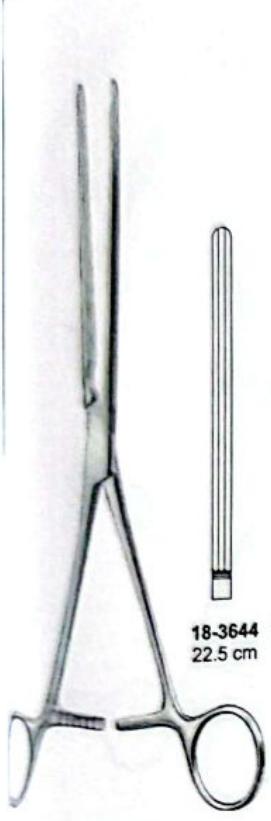

18-3644 22.5 cm
18-3645 25 cm
18-3646 28 cm

18-3644-18-3646
Kocher

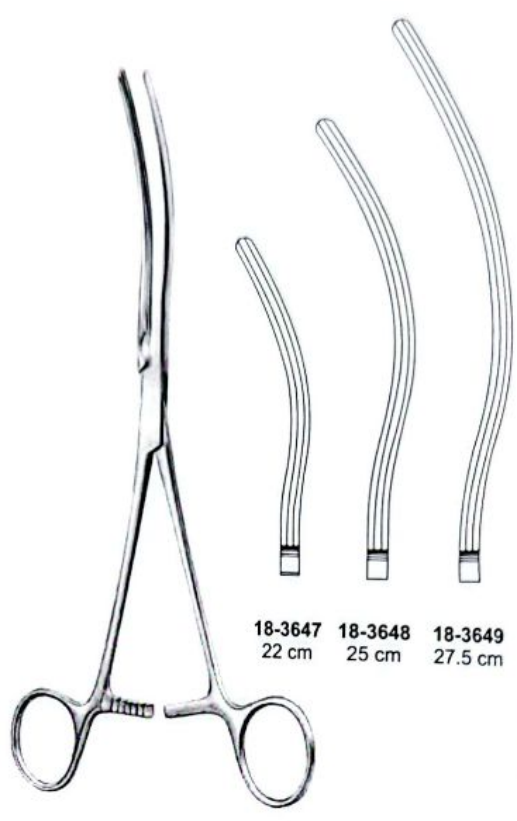

18-3647 22 cm
18-3648 25 cm
18-3649 27.5 cm

18-3647-18-3649
Kocher



18-3650
Allen
16 cm



18-3651
Payr-Baby
15 cm



18-3652 21 cm
18-3653 29 cm
18-3654 34 cm

18-3652-18-3654
Payr



18-3655
Benson
15.5 cm

Intestinal Anastomosis Clamps

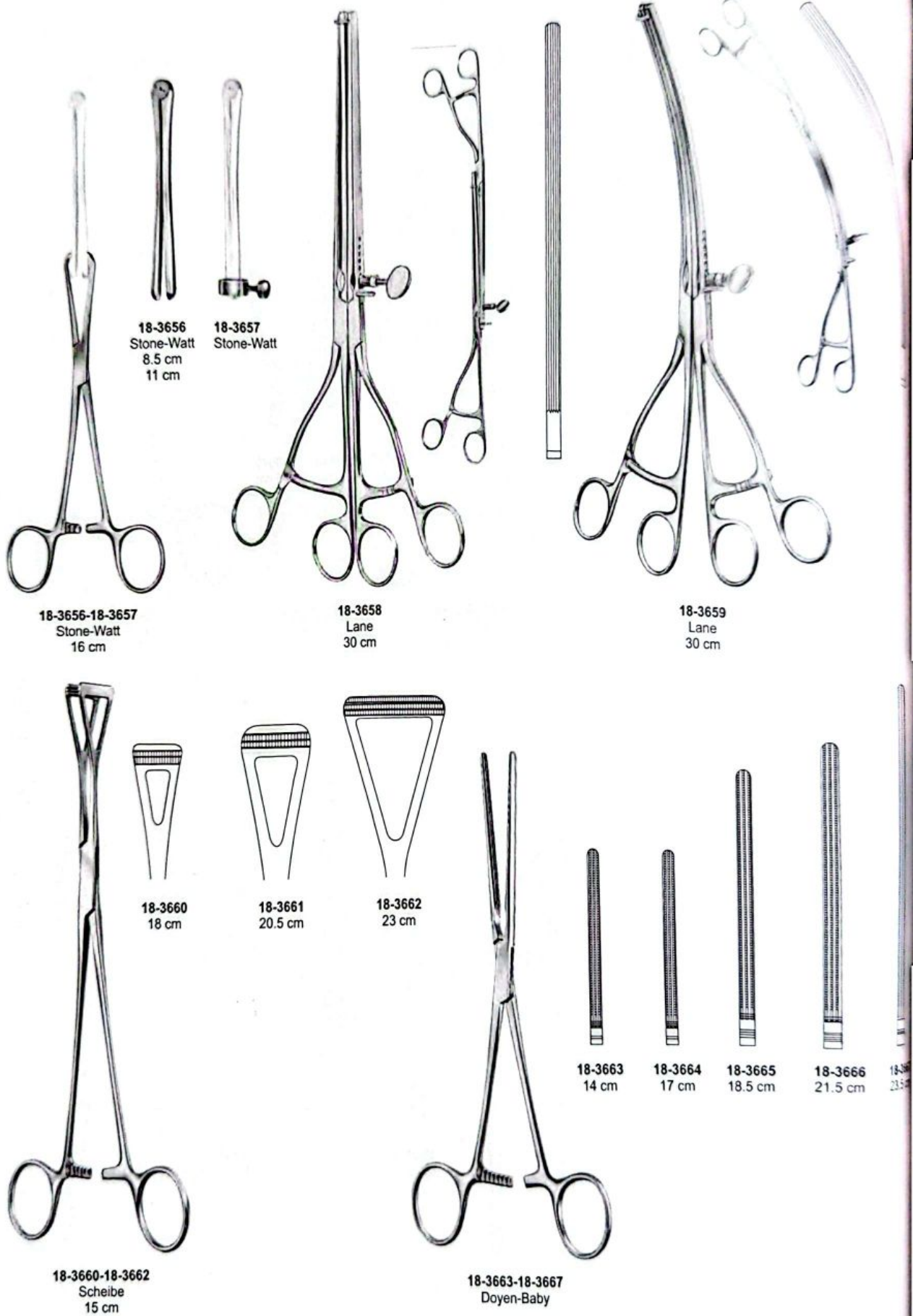

18-3656
Stone-Watt
8.5 cm
11 cm

18-3657
Stone-Watt

18-3658
Lane
30 cm

18-3659
Lane
30 cm

18-3656-18-3657
Stone-Watt
16 cm

18-3660
18 cm

18-3661
20.5 cm

18-3662
23 cm

18-3663
14 cm

18-3664
17 cm

18-3665
18.5 cm

18-3666
21.5 cm

18-3660-18-3662
Scheibe
15 cm

18-3663-18-3667
Doyen-Baby



Intestinal Clamps

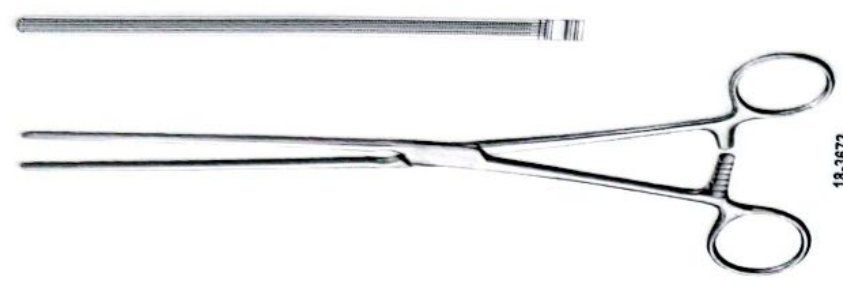

18-3673
Mayo-Robson
26 cm



18-3672
23 cm



18-3671
21 cm



18-3670
18 cm



18-3669
17 cm



18-3668
13.5 cm

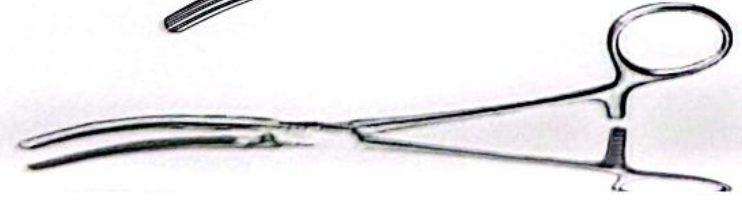

18-3666-18-3672
Doyen-Baby

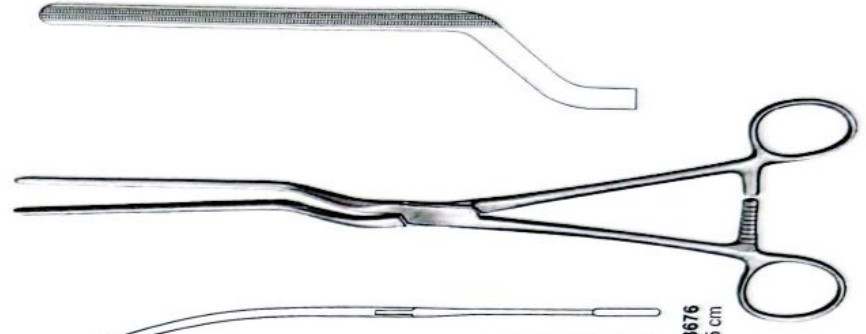

18-3677
Brunner
27 cm



18-3676
32.5 cm

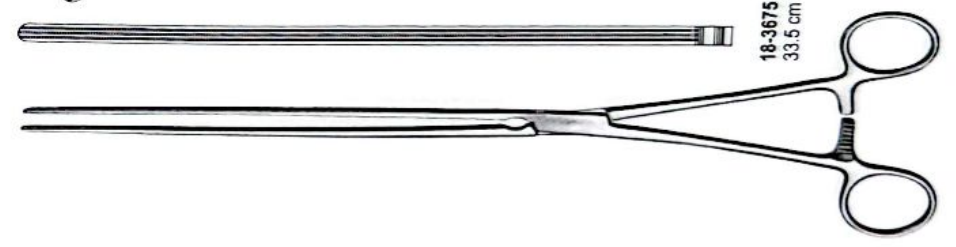

18-3675
33.5 cm

18-3675-18-3676
Scudder



18-3674
Mayo-Robson
25 cm

Sigmoid Anastomosis Forceps



18-3678-18-3679
Hayes



18-3678
27 cm

18-3679
28 cm



18-3680
Veidenheimer
25 cm



18-3681
Fehland
24 cm

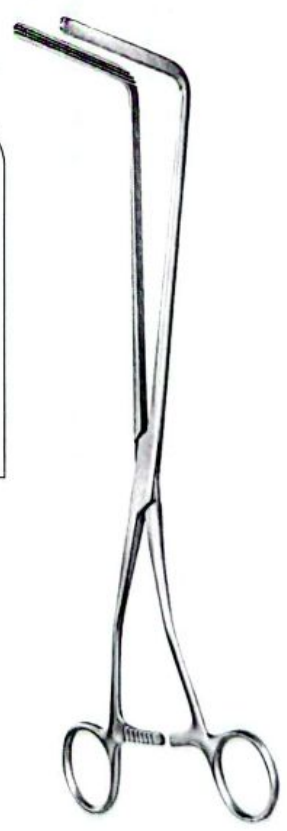

18-3682
Resano
28 cm



Rectal Specula, Sphincteroscopes,
Hemorrhoidal Ligator

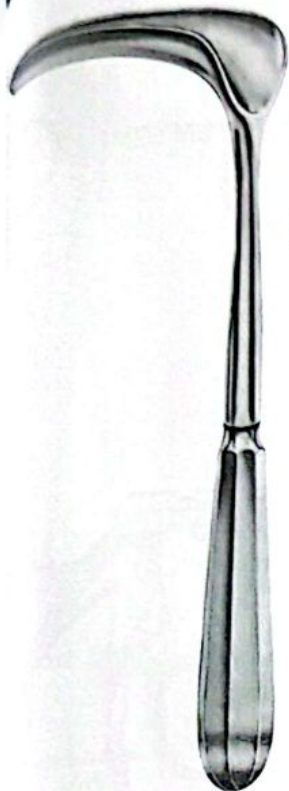

18-3683
Czerny
22.5 cm

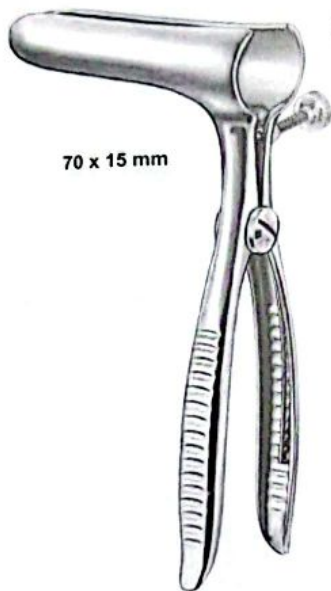

70 x 15 mm

18-3684
Sims
15.5 cm

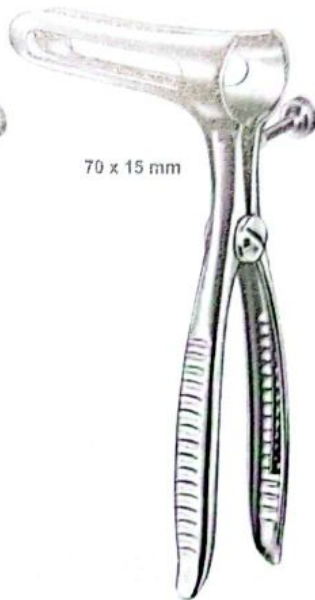

70 x 15 mm

18-3685
Sims
15.5 cm



∅ 22 mm

18-3686
Ives-Fansler
80 mm



18-3687
Alan-Parks
14 cm



18-3688
Kelly

Rectal Biopsy Forceps



18-3689
Rudd
27.5 cm

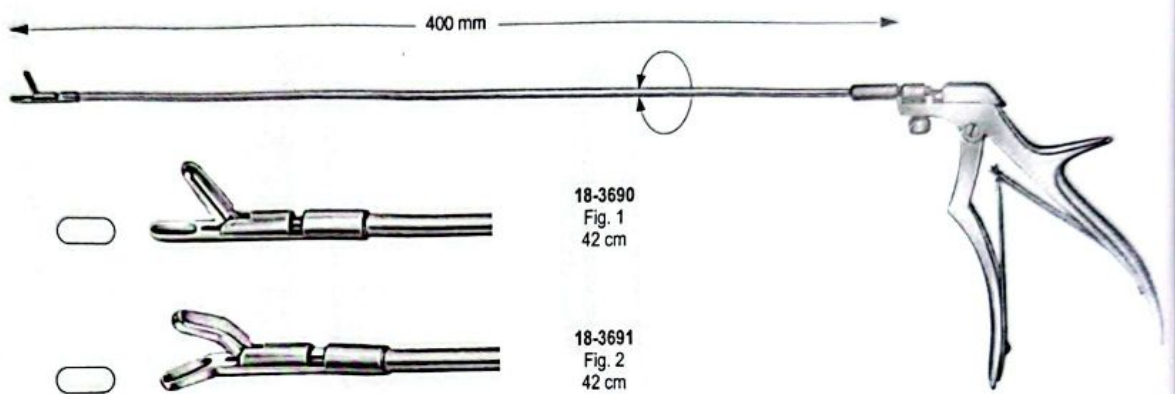

400 mm

18-3690-18-3694



18-3690
Fig. 1
42 cm



18-3691
Fig. 2
42 cm



18-3692
Fig. 3
42 cm



18-3693
Fig. 4
42 cm



18-3694
Fig. 5
42 cm

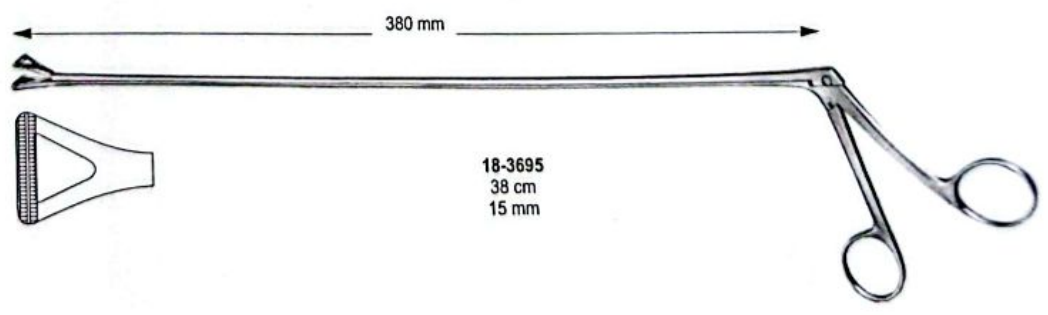

380 mm

18-3695
38 cm
15 mm



Kidney Pedicle Clamp Forceps, Nephrostomy Forceps

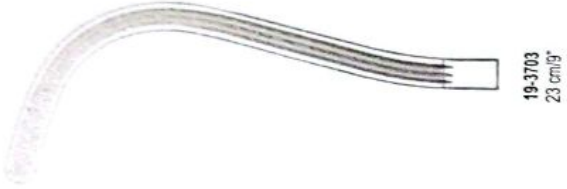
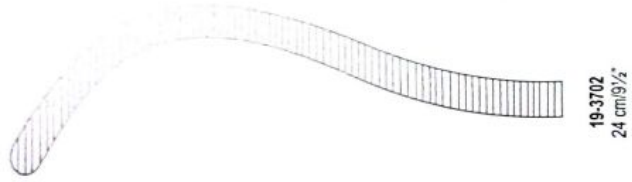
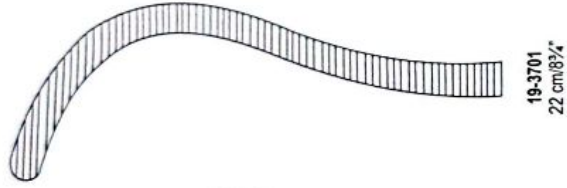
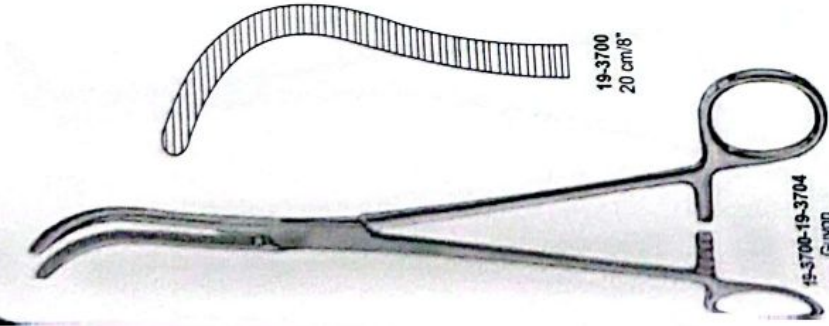

19-3700-19-3704
Guyon

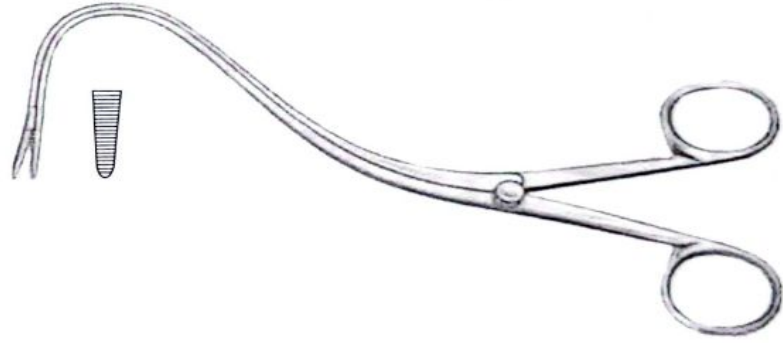
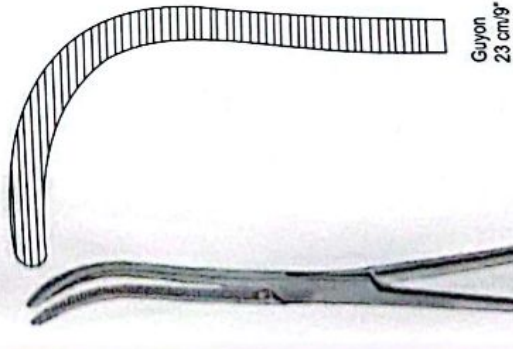

19-3705
Guyon

19-3706
Elsasser
20 cm/8"

19-3707
Randall

Kidney Stones, Gall Duct Forceps



19-3708
Randall

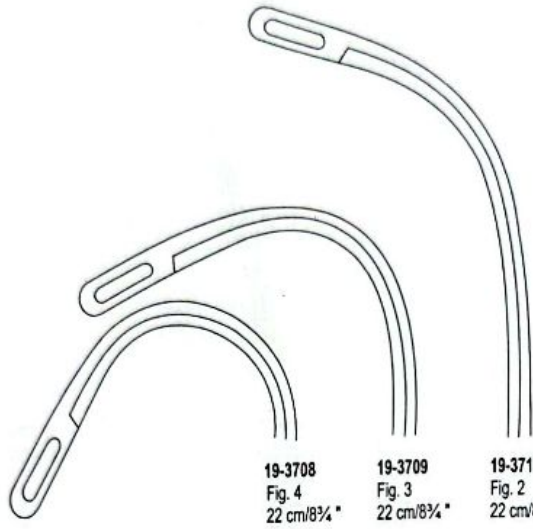

19-3708
Fig. 4
22 cm/8 3/4"

19-3709
Fig. 3
22 cm/8 3/4"

19-3710
Fig. 2
22 cm/8 3/4"

19-3711
Fig. 1
23 cm/8"



19-3712-19-3713
Gray

19-3712
Fig. 1
22 cm/8 3/4"
Set of 2 Pieces



19-3714-19-3715
Gray

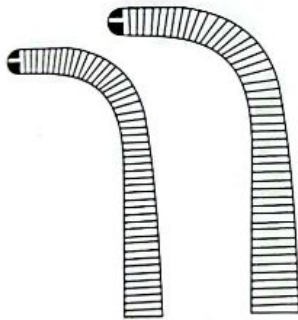

19-3714
Fig. 1
22 cm/8 3/4"

19-3715
Fig. 2
34 23 cm/9"

Set of 2 Pieces

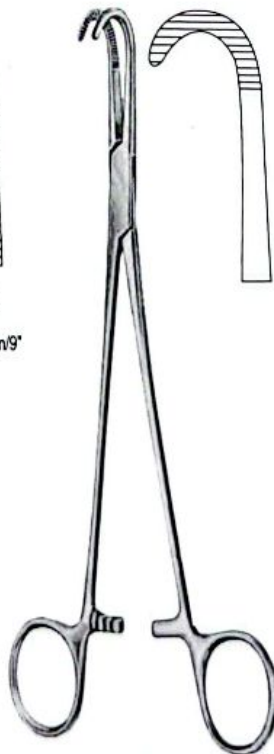

19-3716
Desjardins
21 cm/8 1/4"

Gall duct and
cystic forceps



19-3717
Nissen
21.5 cm/8 1/2"



Gall Stone Forceps, Gall Duct Dilators

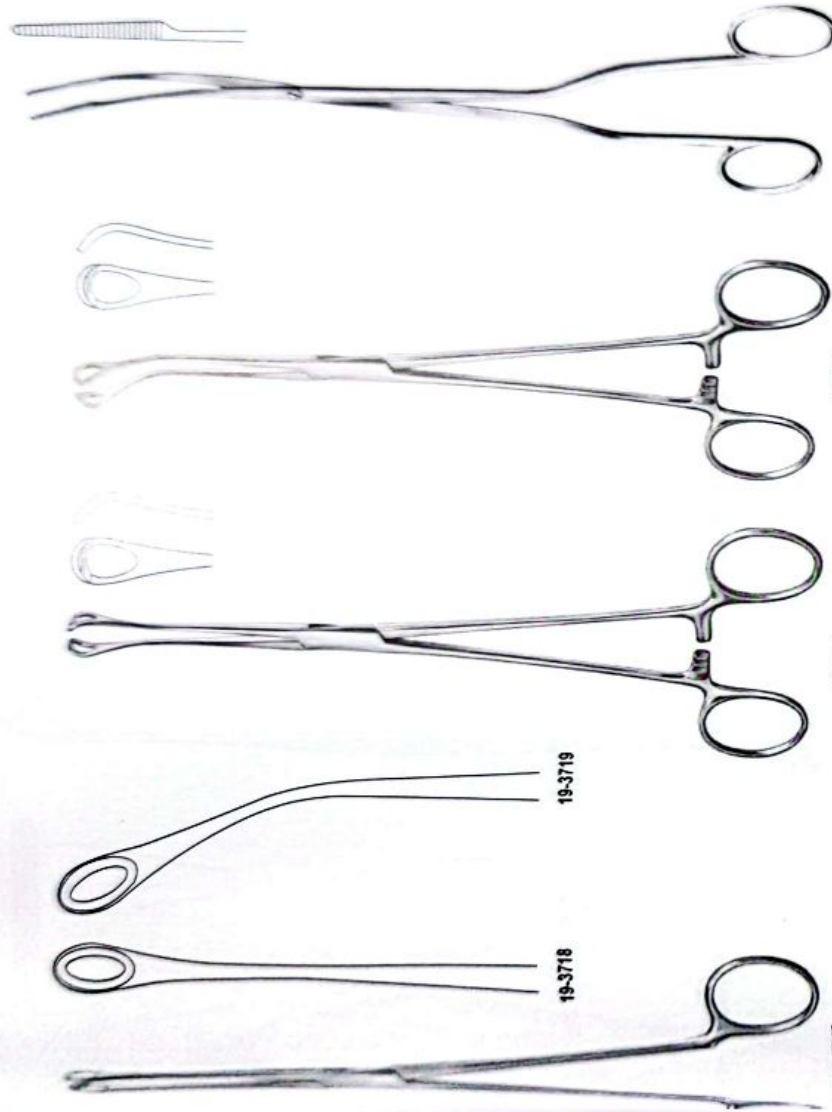

19-3718

19-3719

19-3720
Mayo-Blake
21 cm / 8 3/8"

19-3721
Mayo-Blake
21 cm / 8 3/8"

19-3722
Cooney
24.5 cm / 9 3/4"

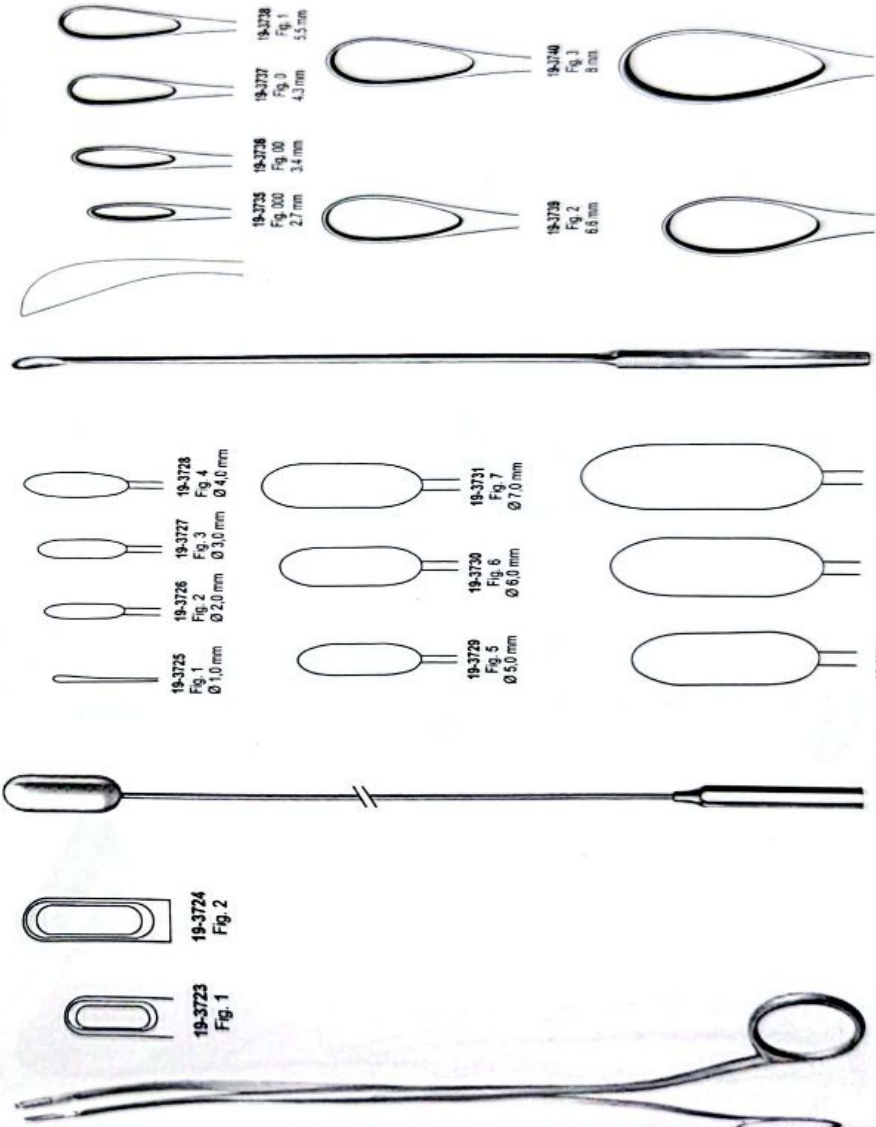

19-3723
Fig. 1

19-3724
Fig. 2

19-3725 Fig. 1 Ø 1.0 mm
19-3726 Fig. 2 Ø 2.0 mm
19-3727 Fig. 3 Ø 3.0 mm
19-3728 Fig. 4 Ø 4.0 mm

19-3729 Fig. 5 Ø 5.0 mm

19-3730 Fig. 6 Ø 6.0 mm

19-3731 Fig. 7 Ø 7.0 mm

19-3732-19-3734
Baker's
32 cm / 12 5/8"

19-3732 Fig. 8 Ø 6.0 mm
19-3733 Fig. 9 Ø 9.0 mm
19-3734 Fig. 10 Ø 10.0 mm

19-3735-19-3742
Luer-Körte
32 cm / 12 5/8"

19-3735 Fig. 00 2.7 mm

19-3736 Fig. 00 3.4 mm

19-3737 Fig. 0 4.3 mm

19-3738 Fig. 1 5.5 mm

19-3739 Fig. 2 6.6 mm

19-3740 Fig. 3 8 mm

19-3741 Fig. 4 11 mm

19-3742 Fig. 5 15 mm

Gall Stone Scoops, Prostatic Retractors

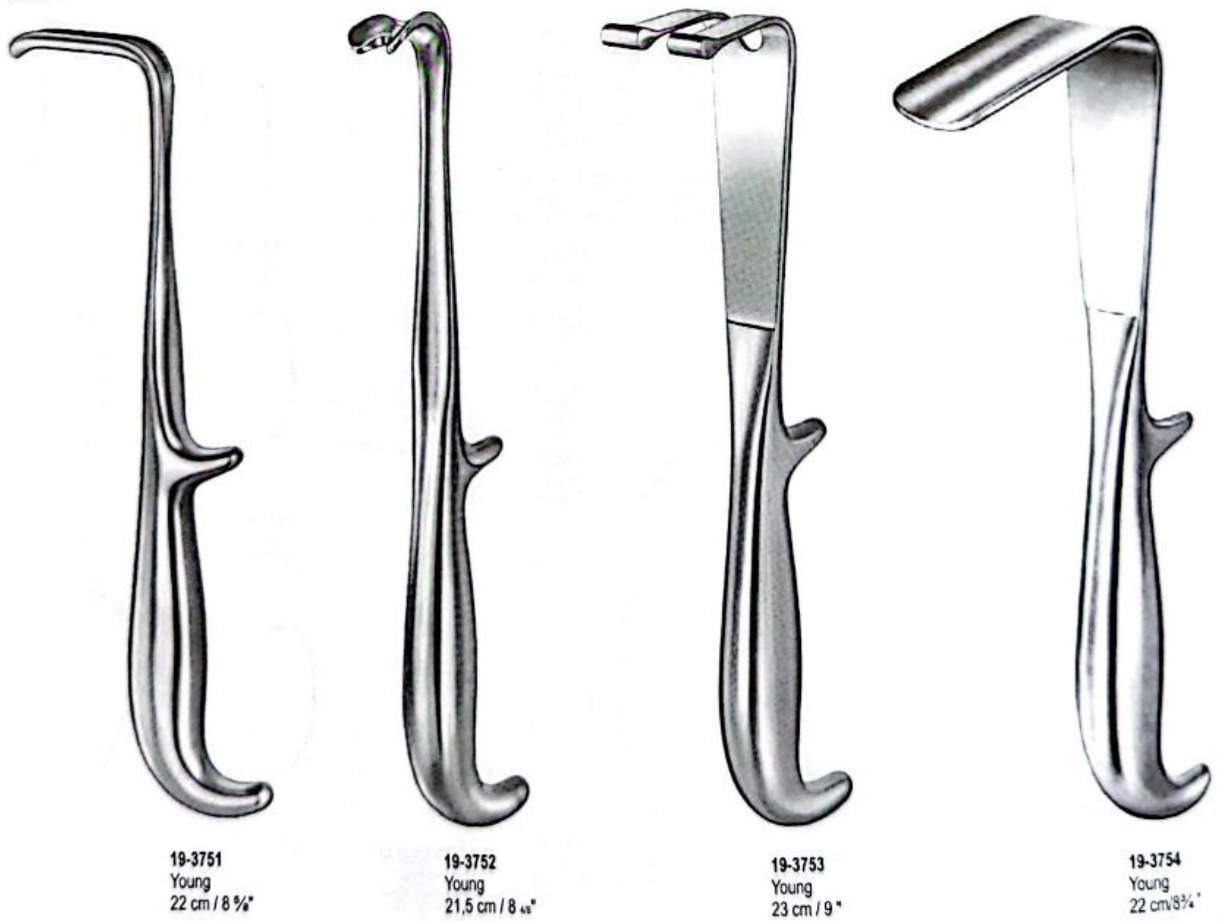
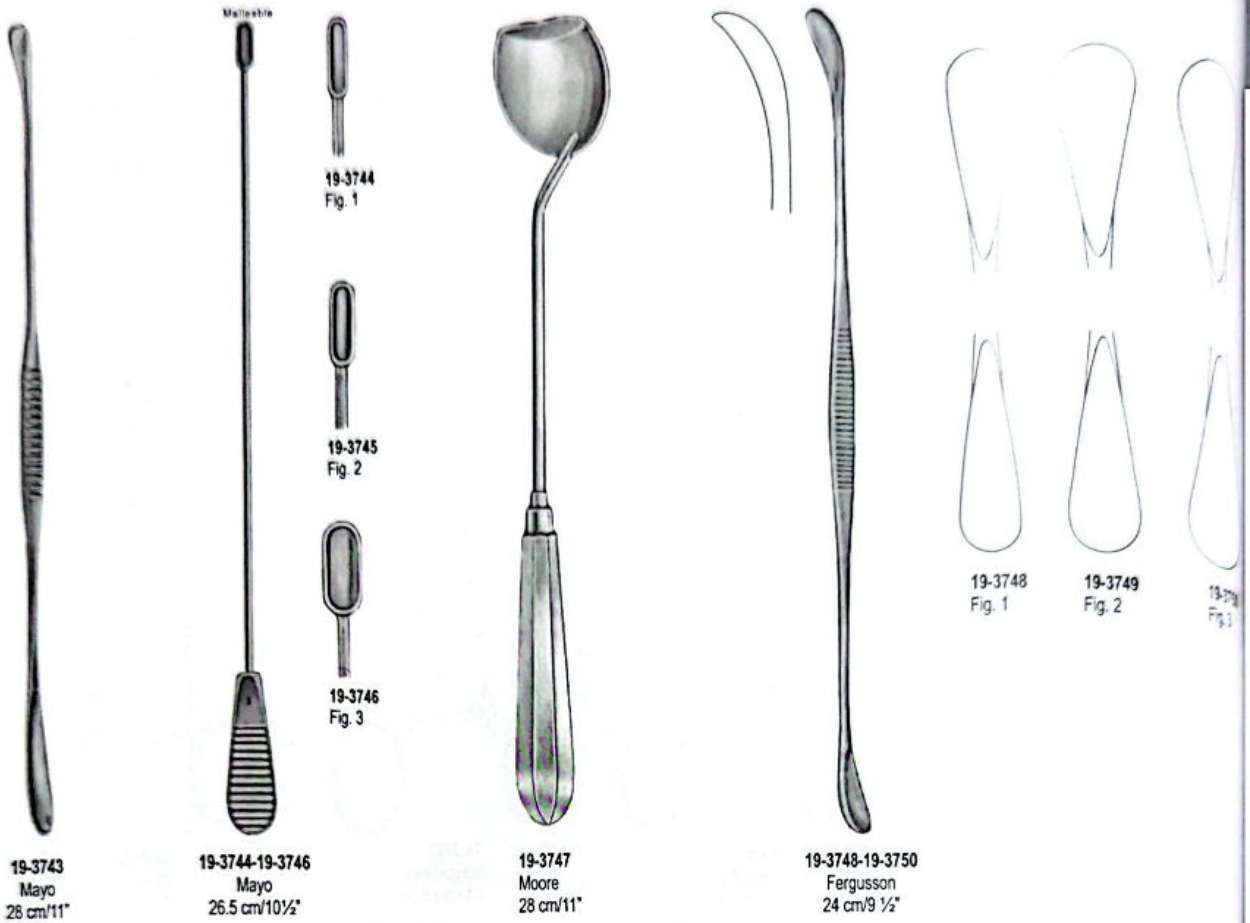

Capsule Forceps, Ligature Carrying Forceps,
Bladder Neck Spreader



19-3757
Millin
24.5 cm / 9 3/4"

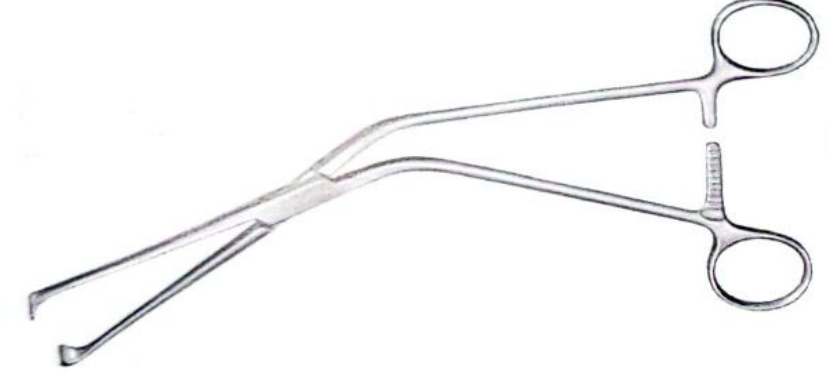

19-3756
Millin
22.5 cm / 8 7/8"

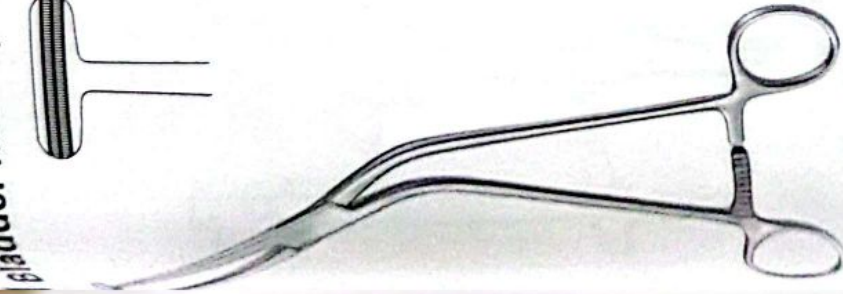

19-3755
Millin
24.5 cm / 9 3/4"



19-3760
Millin
29.5 cm / 11 3/4"

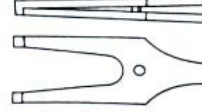

19-3759
Millin
24 cm / 9 4/8"

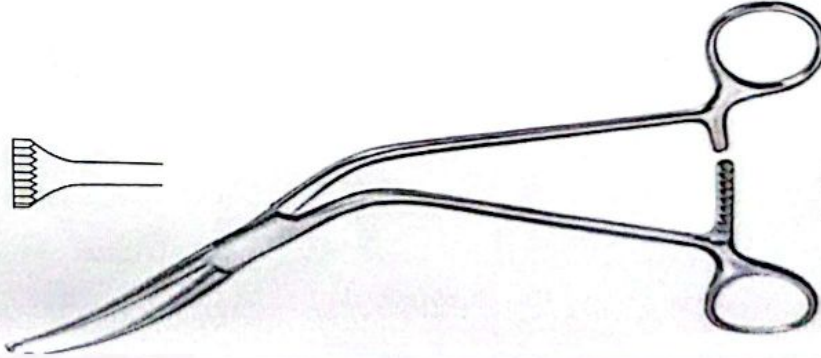
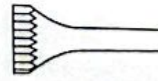

19-3758
Millin
22 cm / 8 5/8"

Bladder Neck Spreader, Bladder Retractors

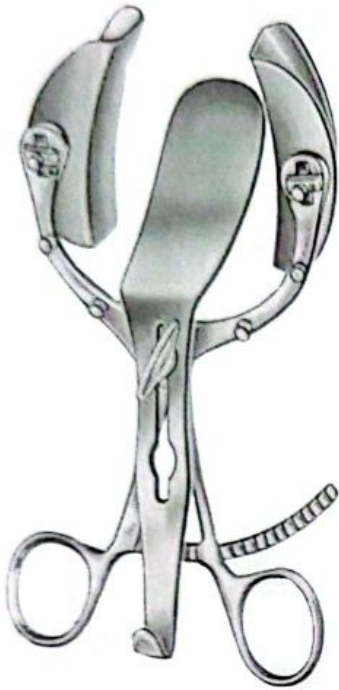

19-3761
Legueu

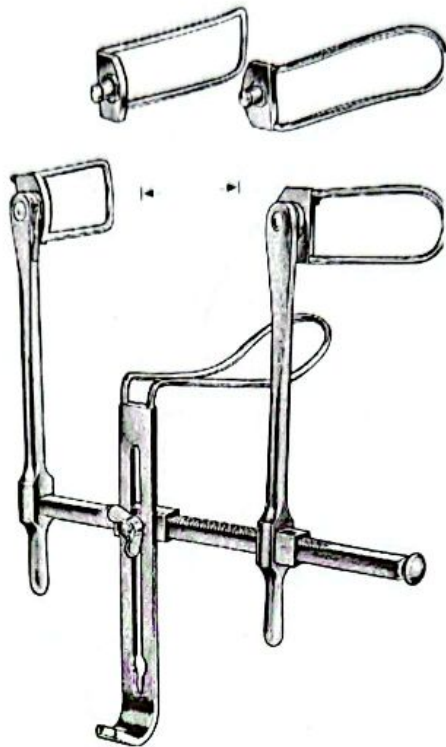

19-3762
Gosset

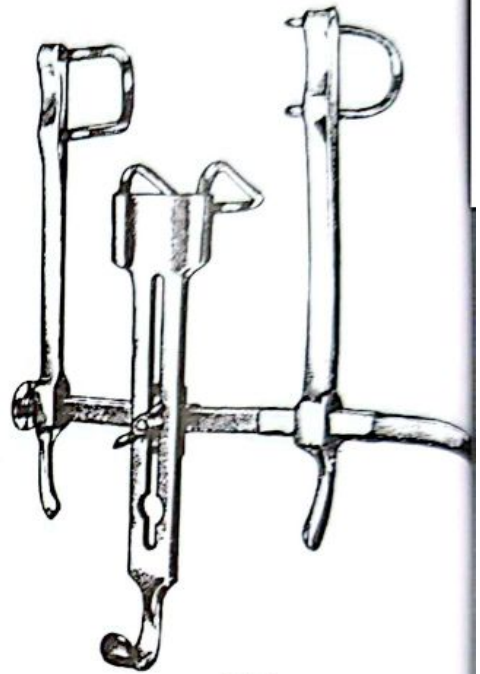

19-3763
Pantings

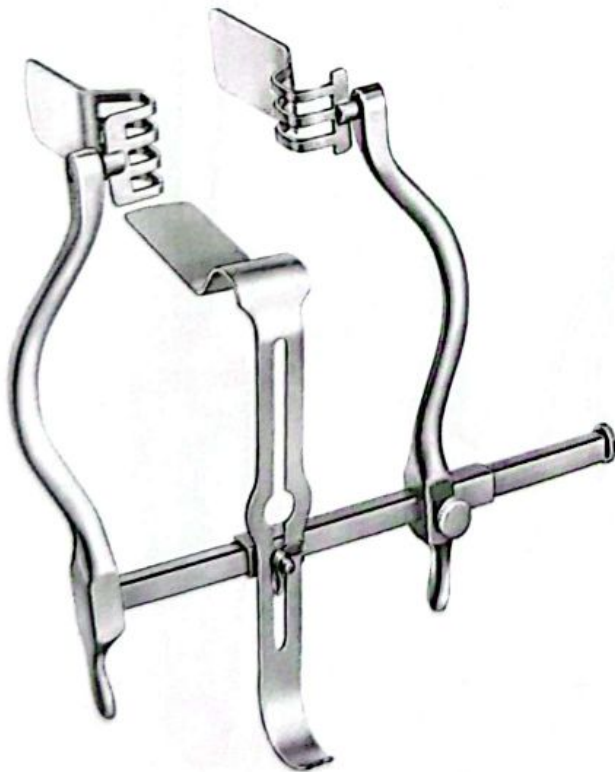

19-3764
Judd-Masson



19-3765-19-3768
Millin



19-3765



19-3766



19-3767



19-3768



Bladder Retractors



19-3769
Thomson-Walker

19-3770
Legueu
27 cm/10 1/2"

19-3771
Kocher
26 cm/10 1/4"

19-3772
Kocher
26 cm/10 1/4"

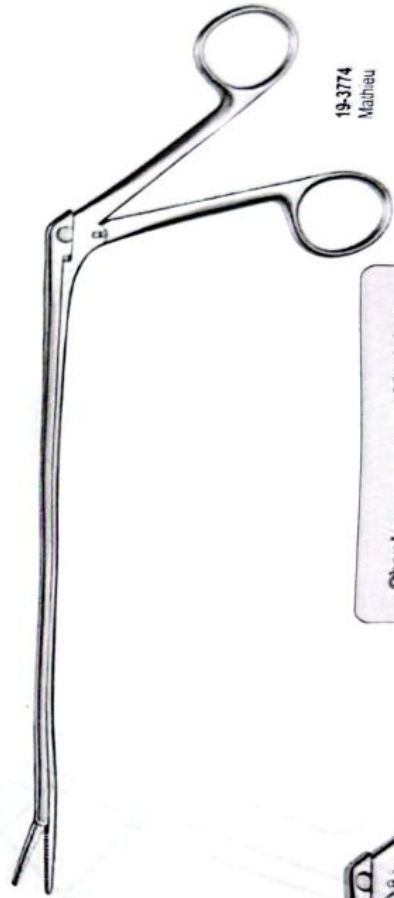
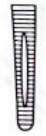

19-3774
Maheü

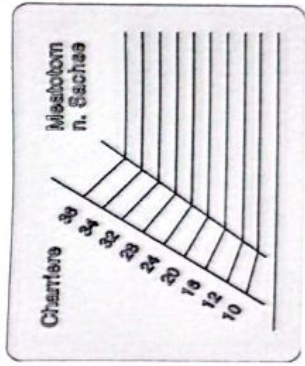

19-3773
Sachse



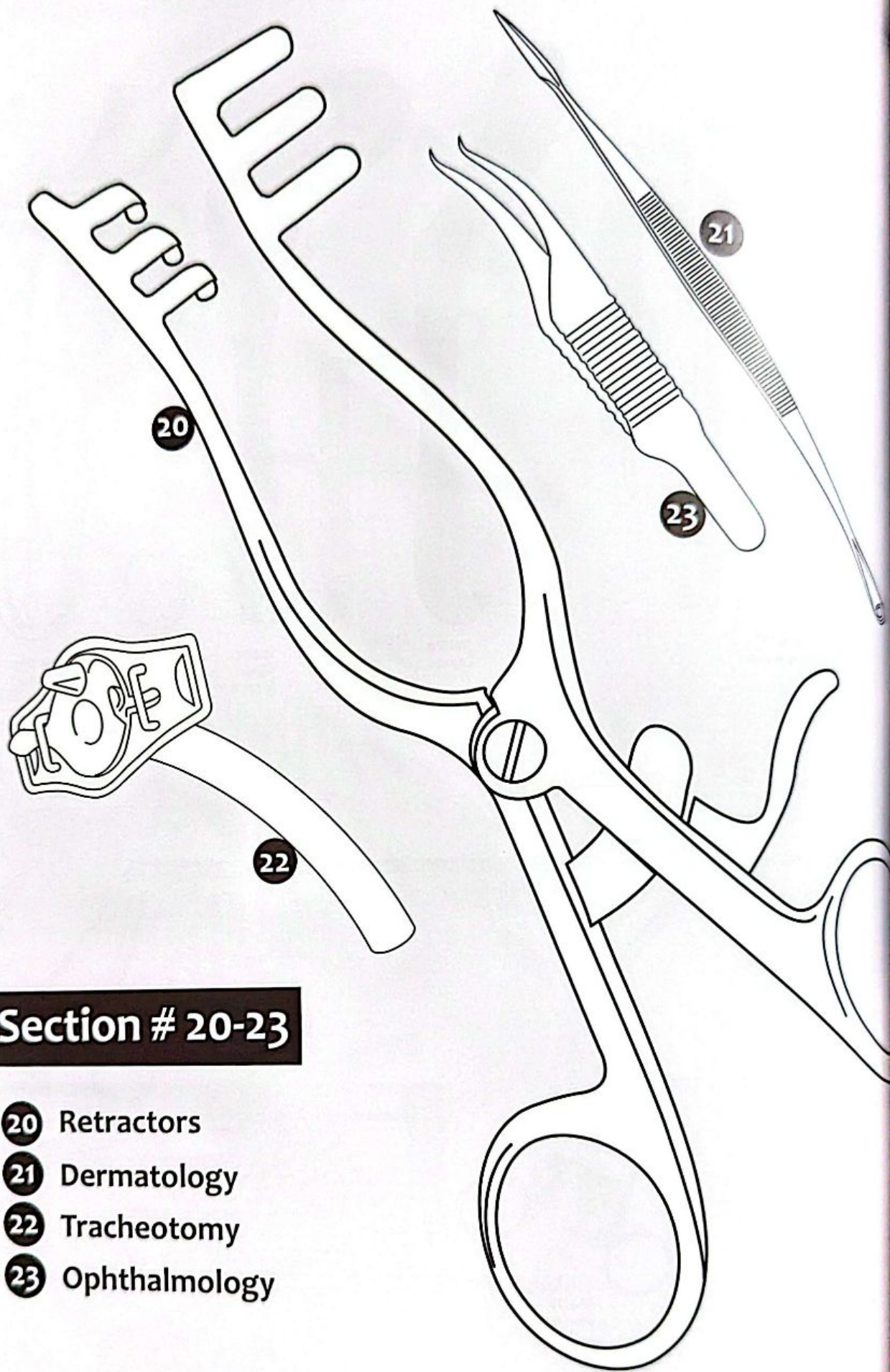

Section # 20-23

- 20** Retractors
- 21** Dermatology
- 22** Tracheotomy
- 23** Ophthalmology

Intestinal and Tissue Grasping Forceps

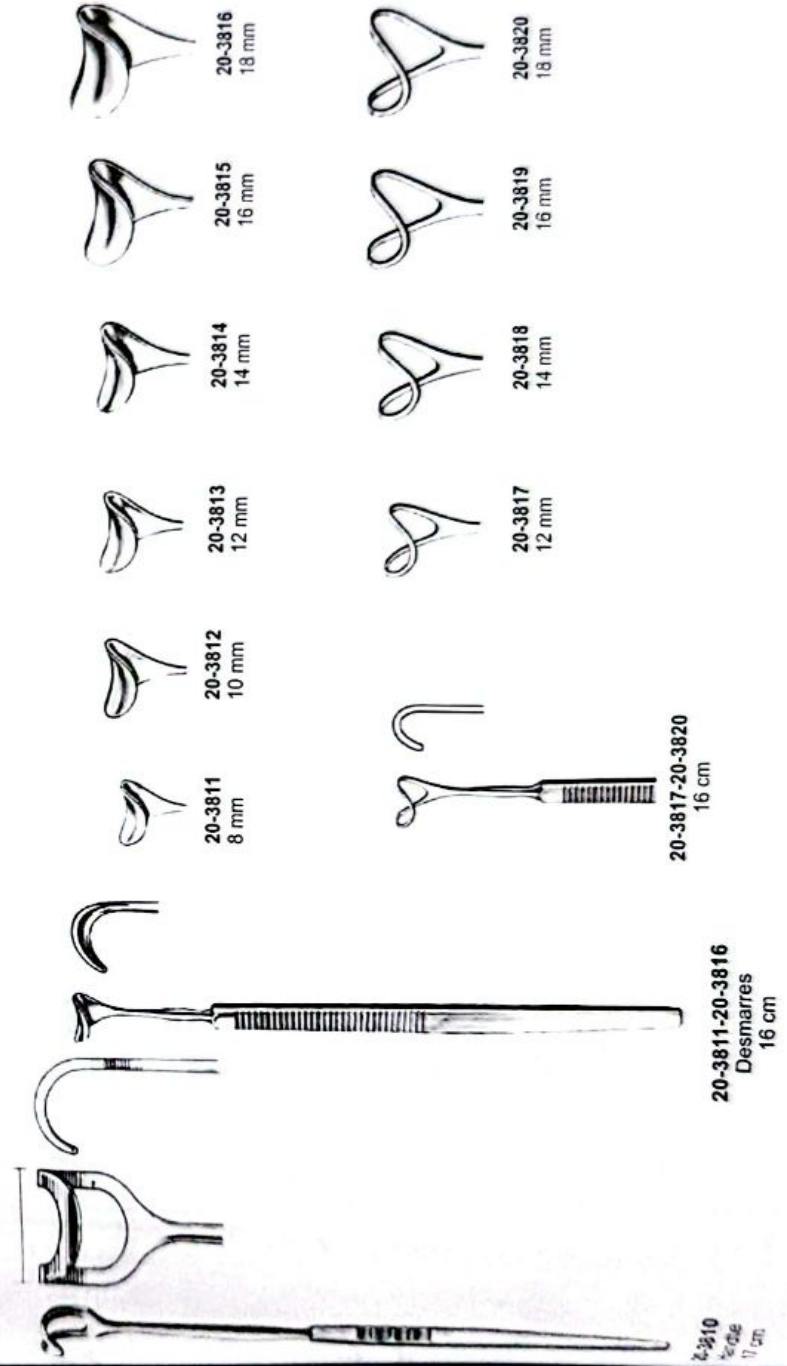
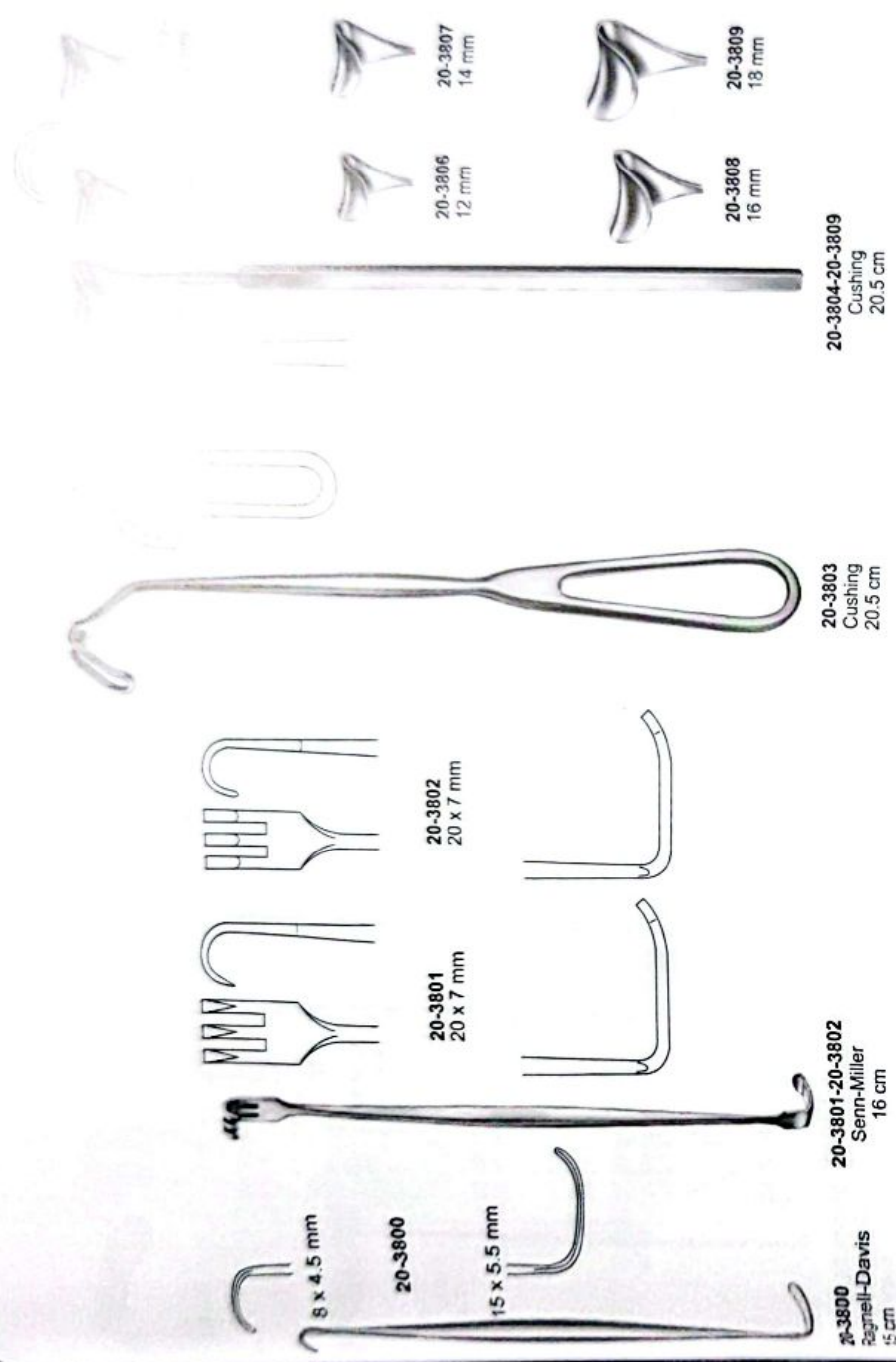

Saddle Hooks, Hooklets, Retractors



20-3821-20-3826
Desmarres
16 cm

20-3827-20-3830
Desmarres
16 cm

20-3831
16 cm

20-3832-20-3833
Senn-Green
16 cm

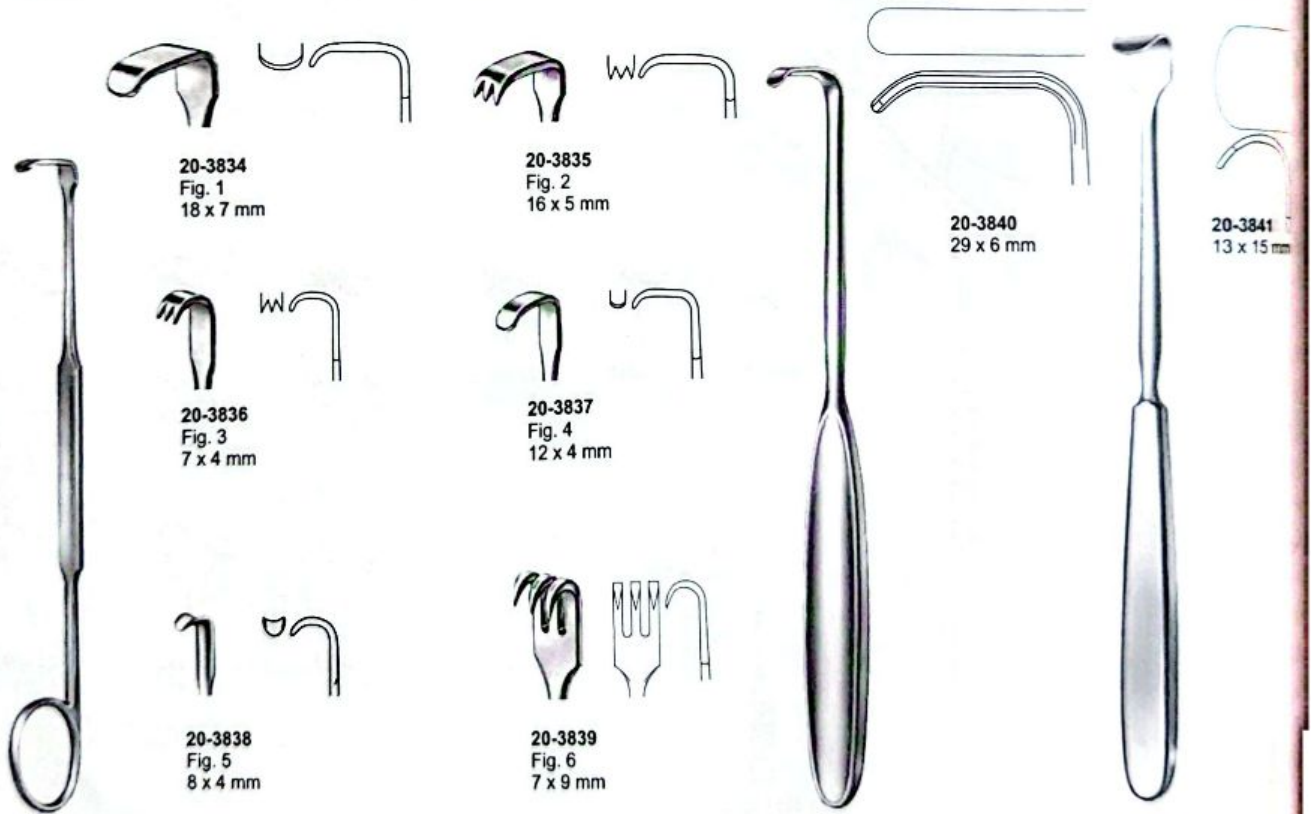

20-3834-20-3839
Meyerding
18 cm

20-3840
Lahey
19.5 cm

20-3841
Little
20.5 cm



Retractors, Micro Hooklets, Skin Hooks, and Skin Holders

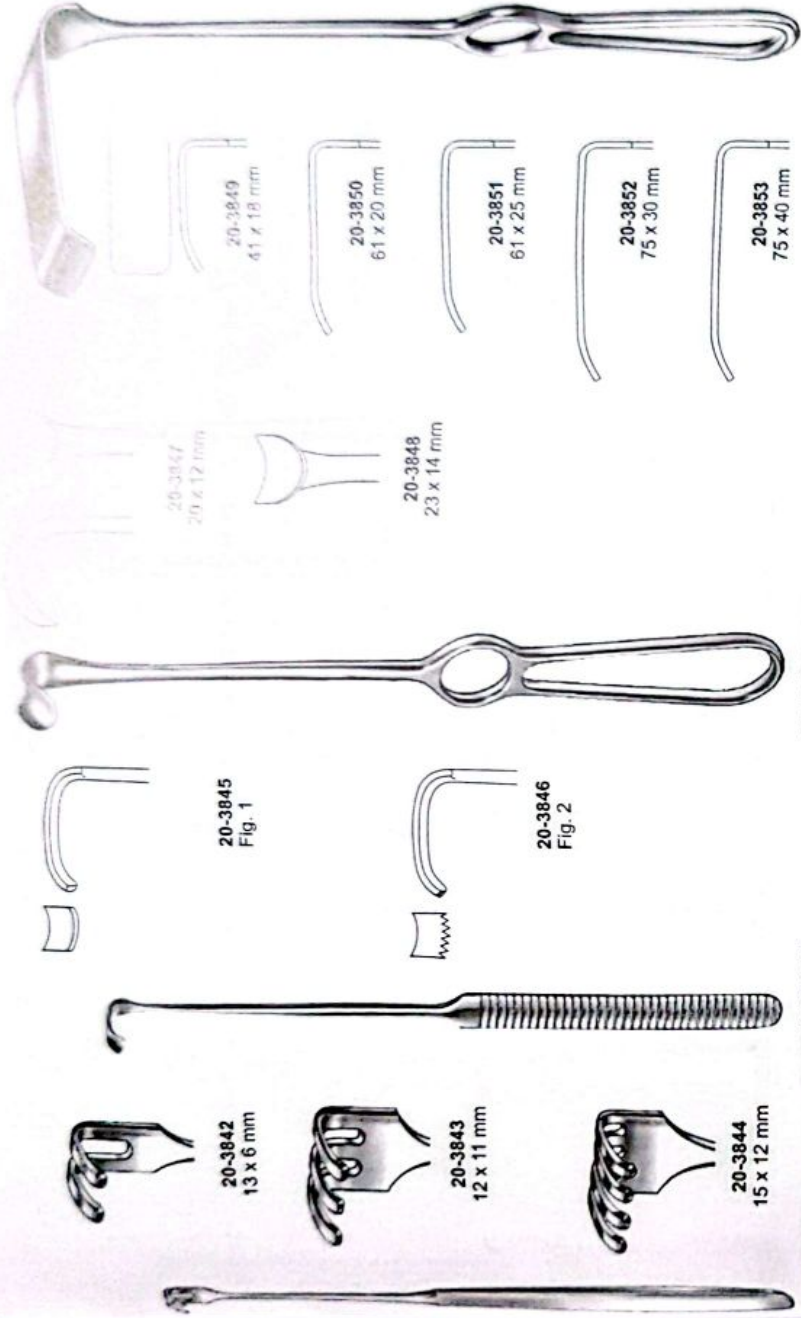

20-3842
13 x 6 mm

20-3843
12 x 11 mm

20-3844
15 x 12 mm

20-3845
Fig. 1

20-3846
Fig. 2

20-3847
29 x 12 mm

20-3848
23 x 14 mm

20-3849
41 x 18 mm

20-3850
61 x 20 mm

20-3851
61 x 25 mm

20-3852
75 x 30 mm

20-3853
75 x 40 mm

20-3842-20-3844
Kapp
18 cm

20-3845-20-3846
Strandell-Stille
19 cm

20-3847-20-3848
Kocher
21.5 cm

20-3849-20-3853
Kocher
23 cm

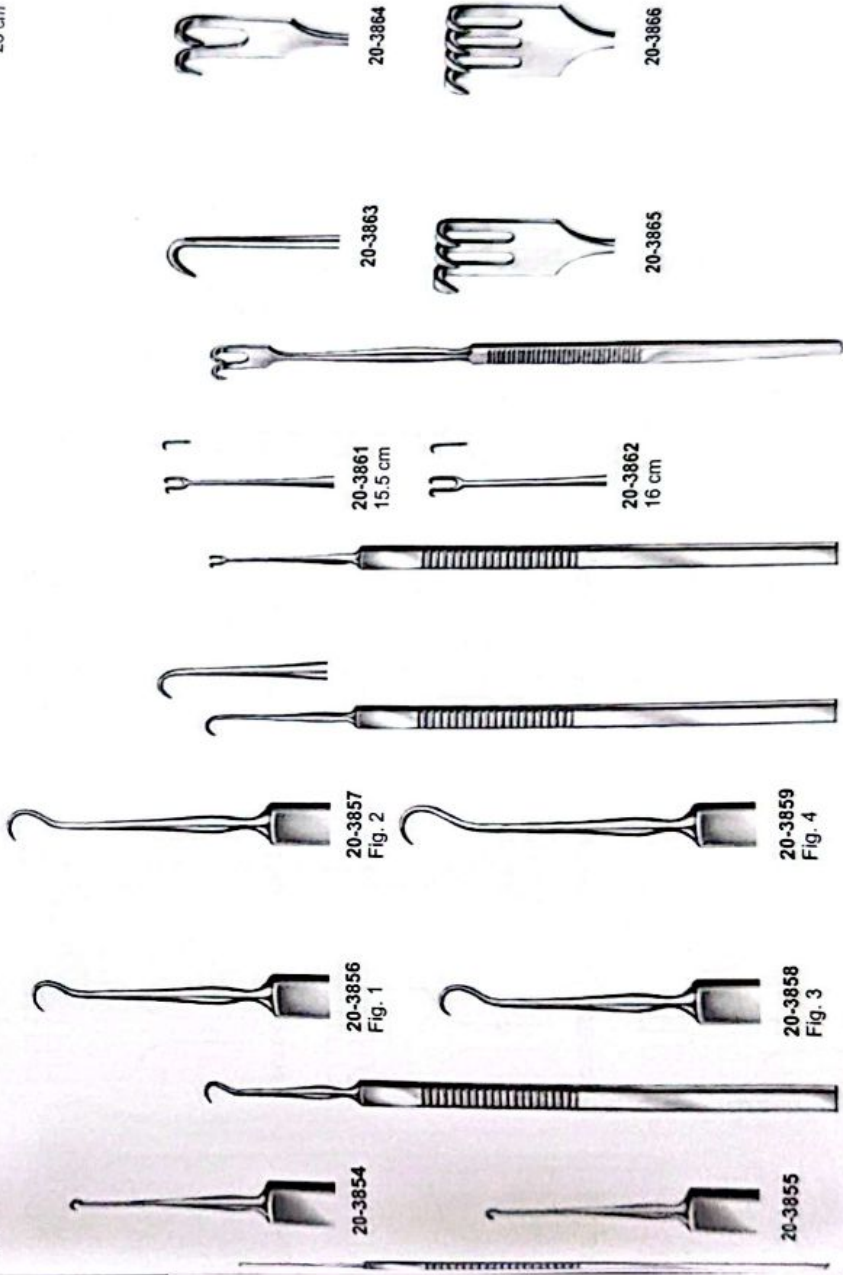

20-3854

20-3855

20-3856
Fig. 1

20-3858
Fig. 3

20-3857
Fig. 2

20-3859
Fig. 4

20-3861
15.5 cm

20-3862
16 cm

20-3863

20-3865

20-3864

20-3866

20-3855
16 cm

20-3856-20-3859
16 cm

20-3860
O'Connor
16 cm

20-3861-20-3862
Guthrie

20-3863-20-3866
16.5 cm



Hooklets, Retractors

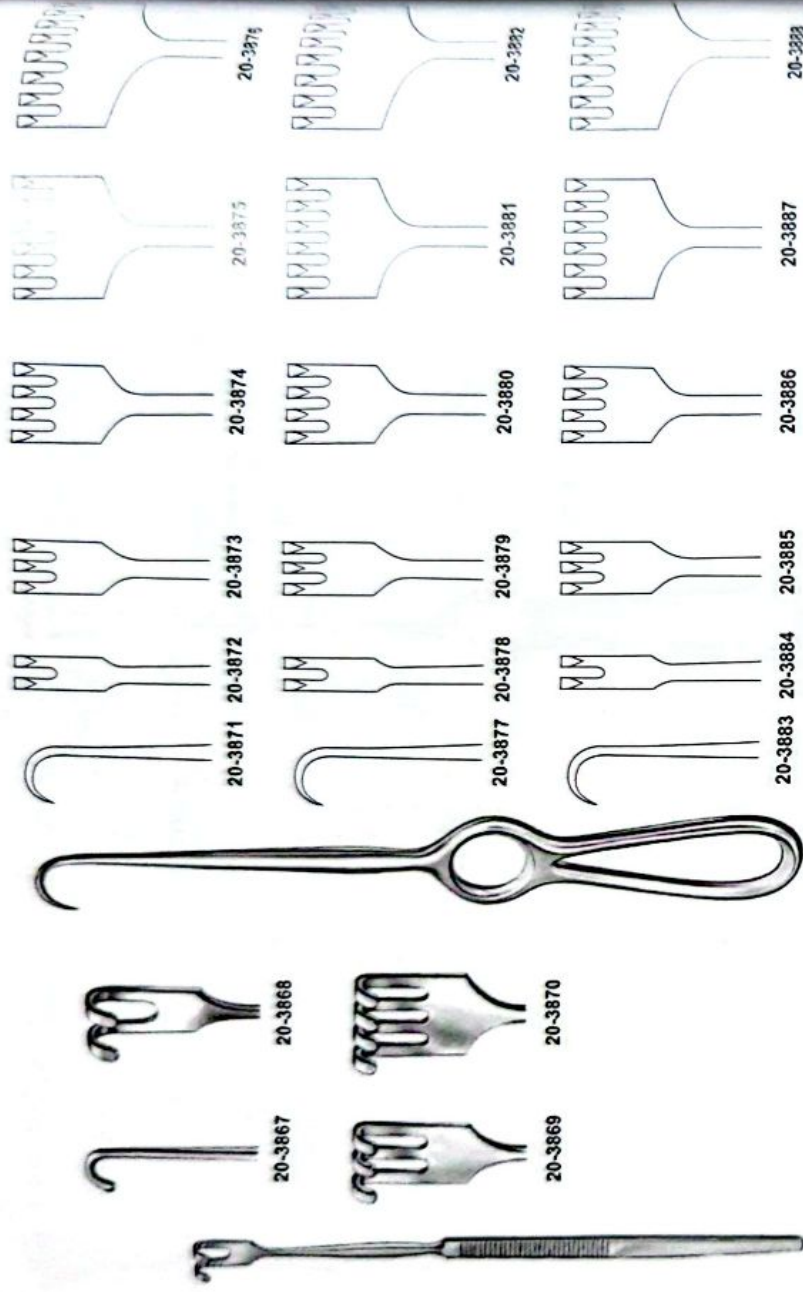

20-3867-20-3870
16.5 cm

20-3867
20-3868

20-3869
20-3870

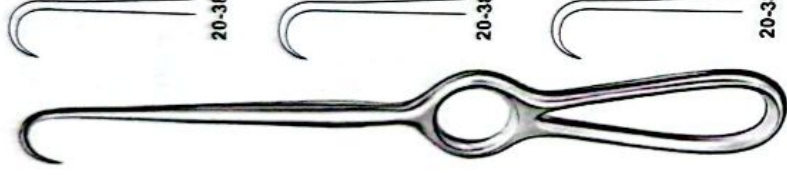

20-3871-20-3888
Kocher
22 cm

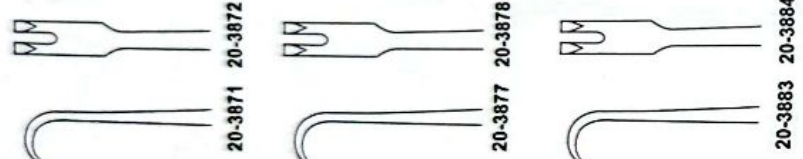

20-3871 20-3872 20-3873 20-3874 20-3875 20-3876 20-3877 20-3878 20-3879 20-3880 20-3881 20-3882 20-3883 20-3884 20-3885 20-3886 20-3887 20-3888



20-3889
Ollier
24.5 cm
37 x 30 mm

20-3890
Ollier
23 cm
39 x 60 mm

20-3891-20-3905
Voikmann
22 cm

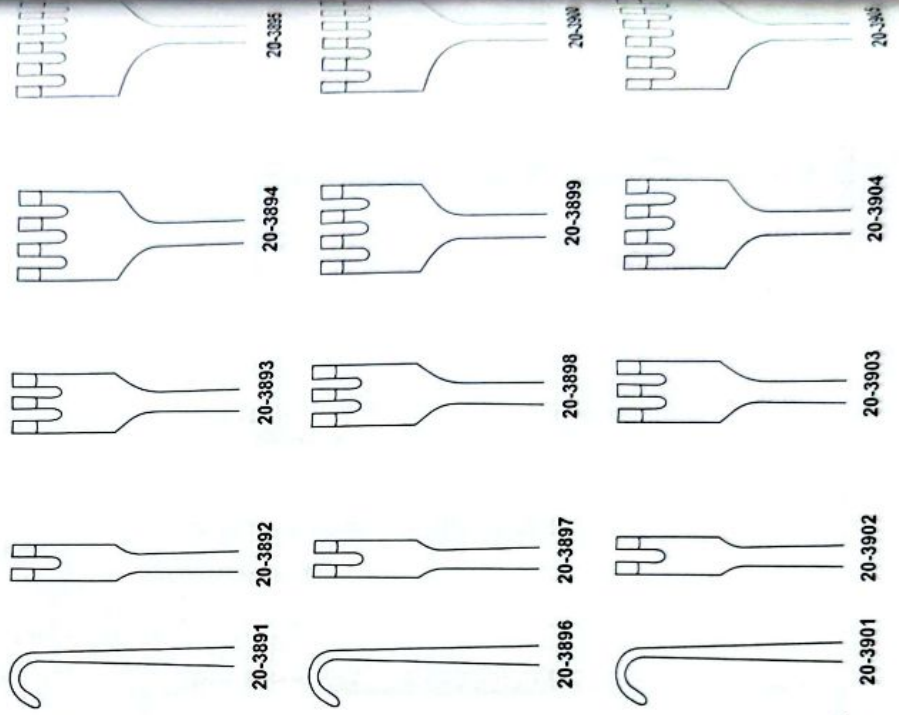

20-3891 20-3892 20-3893 20-3894 20-3895 20-3896 20-3897 20-3898 20-3899 20-3900 20-3901 20-3902 20-3903 20-3904 20-3905



Hooklets, Retractors



20-3906
Wassmund
20.5 cm
33 x 20 mm



20-3907
Körte
24.5 cm
25 x 40 mm



20-3908
Körte
24.5 cm
25 x 30 mm



20-3909-20-3912
Israel
24.5 cm



20-3909
45 x 45 mm



20-3910
45 x 50 mm



20-3911
50 x 60 mm



20-3912
70 x 70 mm



20-3913
Fig. 1
25 cm
25 x 20 mm
31 x 26 mm



20-3915-20-3917
Richardson



20-3915
23.5 cm
25 x 21 mm



20-3916
24 cm
30 x 29 mm

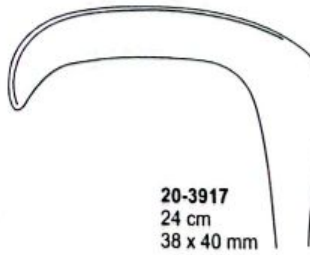

20-3917
24 cm
38 x 40 mm



20-3918
Richardson
24 cm



20-3919
Kelly
26 cm

20-3914
Fig. 2
25 cm
6 x 38 mm
6 x 44 mm

20-3913-20-3914
Richardson-Eastman

Retractors



20-3920-20-3922
Fritsch



20-3920
23.5 cm
37 x 31 mm



20-3923
24 cm
38 x 40 mm



20-3921
25 cm
43 x 51 mm



20-3924
25 cm
49 x 61 mm



20-3922
25.5 cm
48 x 75 mm



20-3925
29.5 cm
65 x 85 mm

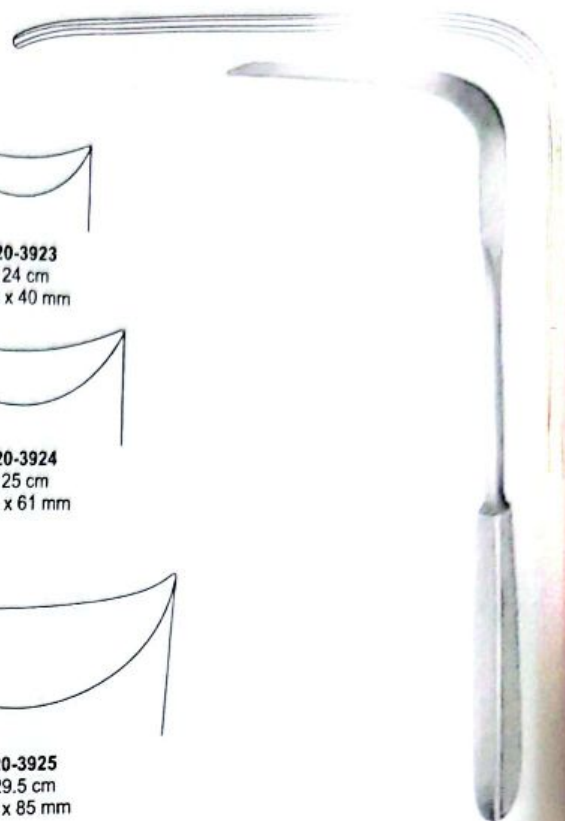

20-3923-20-3925
Tubinger Modell
28 cm

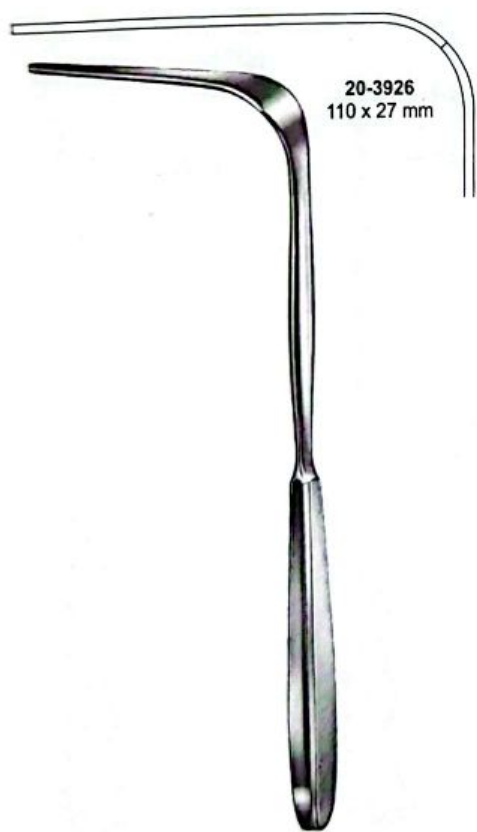

20-3926
Martin
26.5 cm

20-3926
110 x 27 mm



20-3927-20-3928
Simon
28 cm

20-3927
115 x 22 mm

20-3928
115 x 28 mm



20-3929
Simon
28 cm



Retractors



20-3930
Davidson
19 cm
80 x 54 mm



20-3931
Davidson
18.5 cm
75 x 93 mm

20-3932
Sauerbruch
25.5 cm

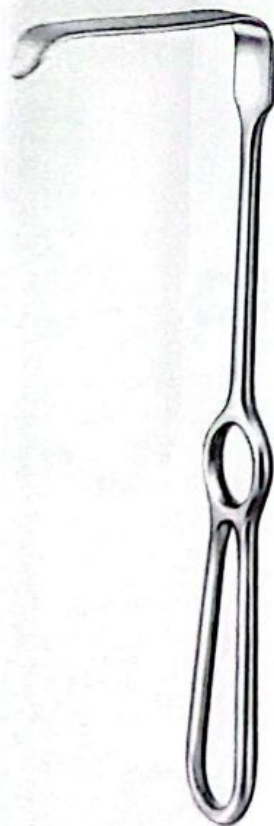

20-3933-20-3938
Brunner
25.5 cm

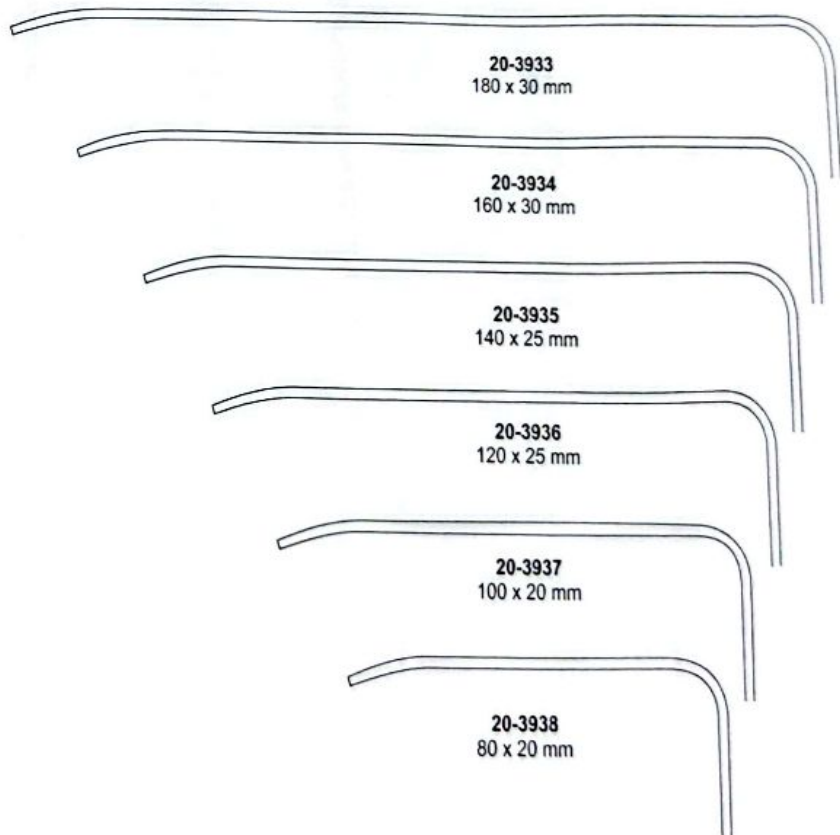

20-3933
180 x 30 mm

20-3934
160 x 30 mm

20-3935
140 x 25 mm

20-3936
120 x 25 mm

20-3937
100 x 20 mm

20-3938
80 x 20 mm



Retractors



20-3939
Deaver
18 cm
19 mm

20-3940
Deaver
21.5 cm
22 mm

20-3941
Deaver
21.5 cm
25 mm

20-3942
Deaver
30.5 cm
25 mm

20-3943
Deaver
33.5 cm
25 mm

20-3944
Deaver
34.5 cm
25 mm



Retractors

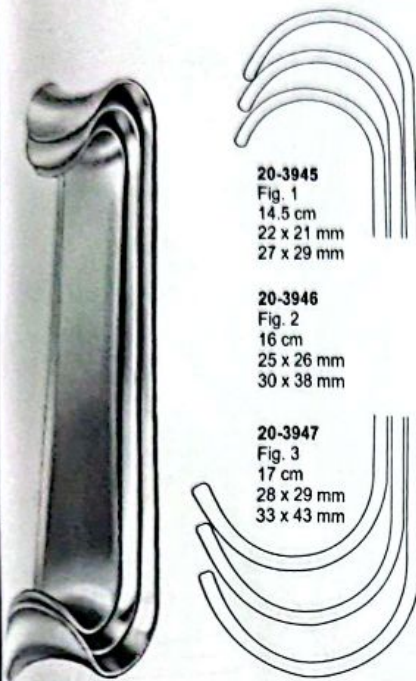

20-3945
Fig. 1
14.5 cm
22 x 21 mm
27 x 29 mm

20-3946
Fig. 2
16 cm
25 x 26 mm
30 x 38 mm

20-3947
Fig. 3
17 cm
28 x 29 mm
33 x 43 mm

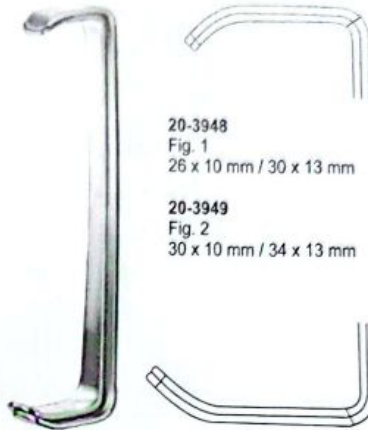

20-3948
Fig. 1
26 x 10 mm / 30 x 13 mm

20-3949
Fig. 2
30 x 10 mm / 34 x 13 mm

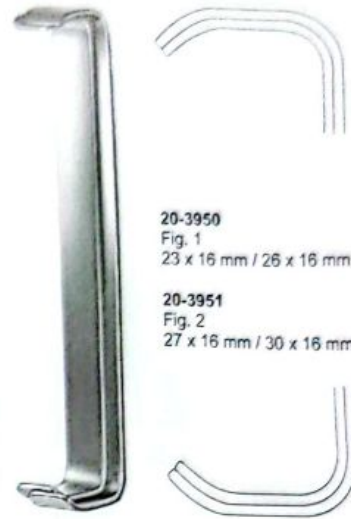

20-3950
Fig. 1
23 x 16 mm / 26 x 16 mm

20-3951
Fig. 2
27 x 16 mm / 30 x 16 mm

20-3945-20-3947
Roux

20-3948-20-3949
Farabeuf
12 cm

20-3950-20-3951
Farabeuf
15.5 cm

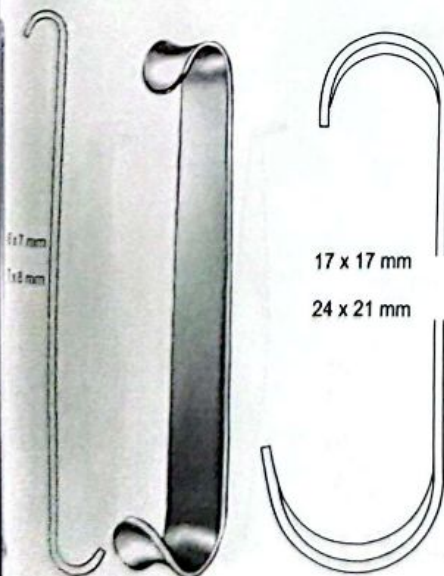

6 x 7 mm
1 x 8 mm

17 x 17 mm

24 x 21 mm

20-3954
Fig. 1
19 x 15 mm / 19 x 15 mm

20-3955
Fig. 2
22 x 15 mm / 22 x 15 mm

20-3956
Fig. 1
26 x 25 mm / 27 x 15 mm

20-3957
Fig. 2
29 x 25 mm / 27 x 25 mm

20-3953
Roux-Baby
12.5 cm

20-3954-20-3955
Parker
14 cm

20-3956-20-3957
Parker
18.5 cm



Retractors



20-3958-20-3959
Parker-Mott



20-3958
Fig. 1
21 x 24 mm
Fig. 2
25 x 24 mm



20-3959
Fig. 1
68 x 24 mm
Fig. 2
72 x 24 mm



20-3960-20-3961
Mathieu
20 cm



20-3960
Fig. 1
42 x 13 mm / 42 x 28 mm

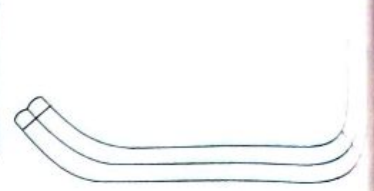

20-3961
Fig. 2
47 x 13 mm / 46 x 28 mm



20-3962-20-3963
Parker-Langenbeck
21.5 cm

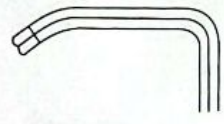

20-3962
Fig. 1
21 x 15 mm / 40 x 15 mm

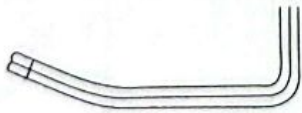

20-3963
Fig. 2
25 x 15 mm / 45 x 15 mm

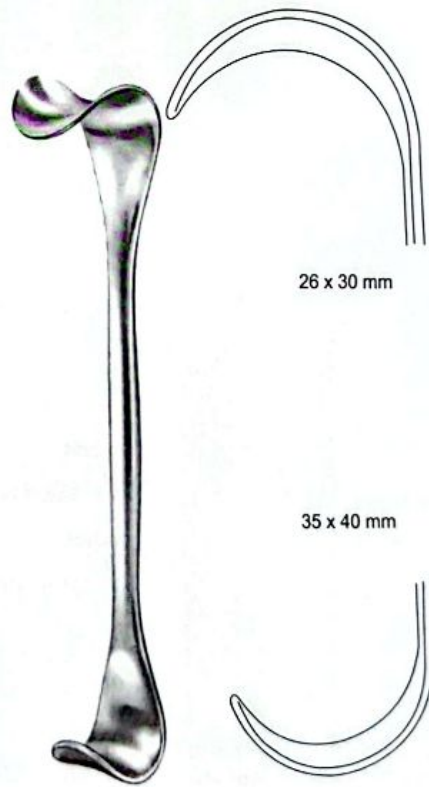

20-3964
Goelet



26 x 30 mm



35 x 40 mm



20-3965
Crile
11 cm



20-3966
Luer
11 cm

A 10 mm
B 8 mm

A 12 mm
B 11 mm



Wound Spreaders, self-retaining



20-3967-20-3970
Finsen



20-3967
5 cm



20-3968
5 cm

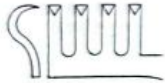

20-3969
7 cm



20-3970
7 cm



20-3971-20-3972
Finsen-Martin
7.5 cm



20-3971
30 mm



20-3972
30 mm



20-3974
16 mm

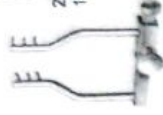

20-3973
Logan
3.5 cm

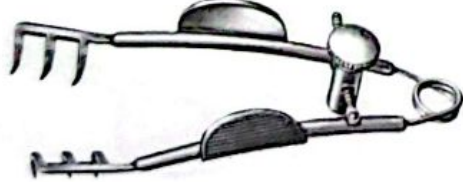

20-3975
Buckley

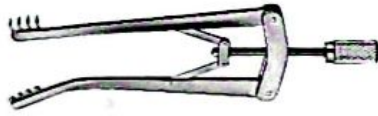

20-3976-20-3979
Alm



20-3976
7 cm

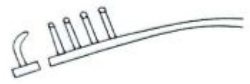

20-3977
10 cm



20-3978
7 cm



20-3979
10 cm



20-3981
24 mm

20-3980
10 cm



20-3982
Jansen
10 cm

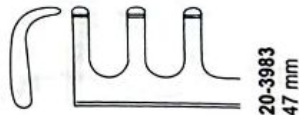

20-3983
47 mm

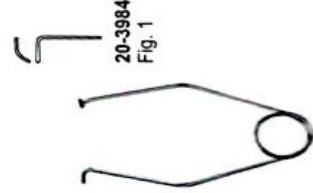

20-3984
3 cm



20-3985
4.5 cm



20-3986
6 cm

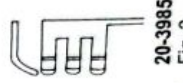

20-3985
Fig. 2

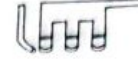

20-3986
Fig. 3



Wound Spreaders, self-retaining



20-3987-20-3988
Scalp-Contour
13.5 cm

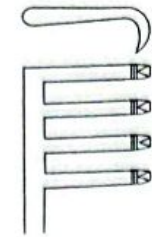

20-3987
13.5 cm

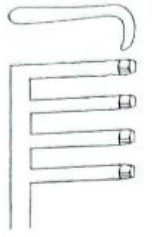

20-3988
13.5 cm

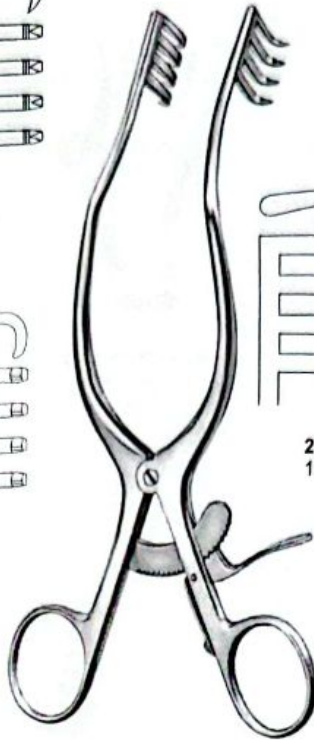

20-3989
Anderson-Adson
19 cm

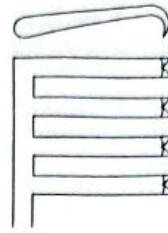

20-3989
19 cm



20-3990-20-3991
Weitlaner
20 cm



20-3990
20 cm

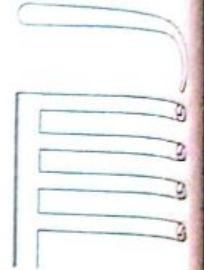

20-3991
20 cm



20-3992-20-3995
Adson

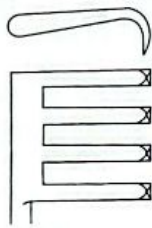

20-3992
26 cm

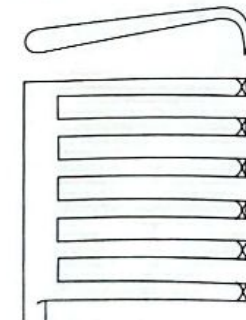

20-3994
29 cm

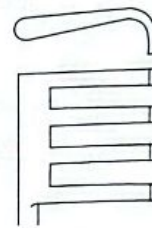

20-3993
26 cm

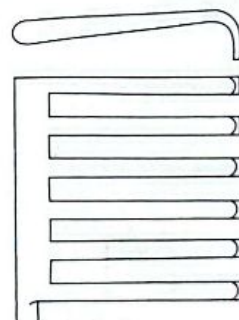

20-3995
29 cm



20-3996-20-3997
Weitlaner
11 cm

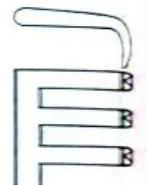

20-3996
11 cm

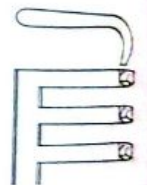

20-3997
11 cm



Wound Spreaders, self-retaining

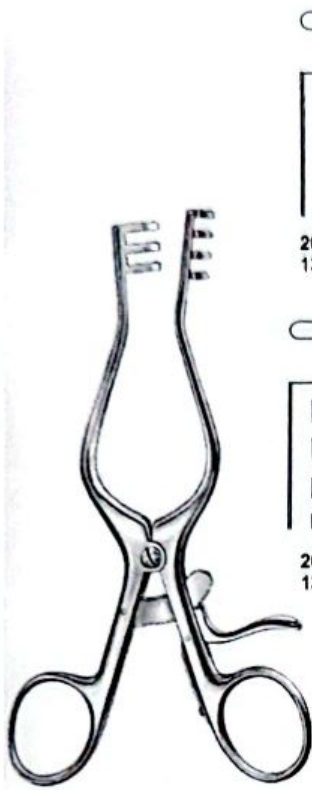

20-3998-20-4001
Scalp-Contour
13.5 cm

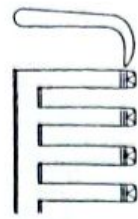

20-3998
13.5 cm

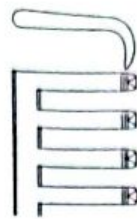

20-3999
16 cm

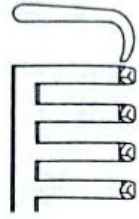

20-4000
13.5 cm

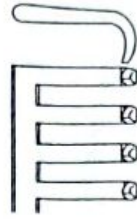

20-4001
16 cm



20-4002-20-4003
Weitlaner-Wullstein
13 cm

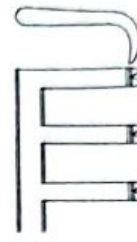

20-4002
40 mm

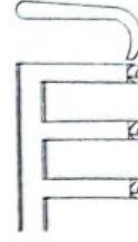

20-4003
40 mm



20-4004
Mollison
15.5 cm

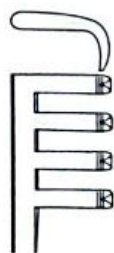

20-4004
80 mm



20-4005-20-4006
Plester
13 cm

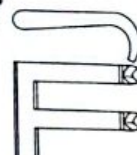

20-4005
37 mm



20-4006
37 mm



20-4007
Plester
10.5 cm

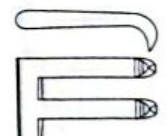

20-4007
37 mm



Wound Spreaders, self-retaining



20-4008
37 mm

20-4008
Plester
10.5 cm

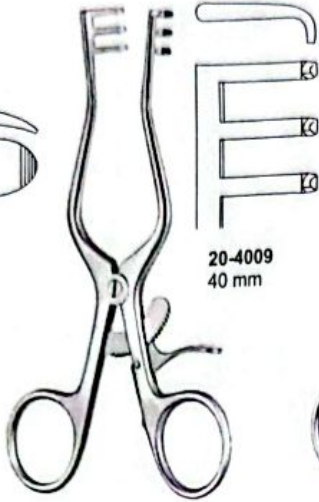

20-4009
40 mm

20-4009
Milligan
13.5 cm

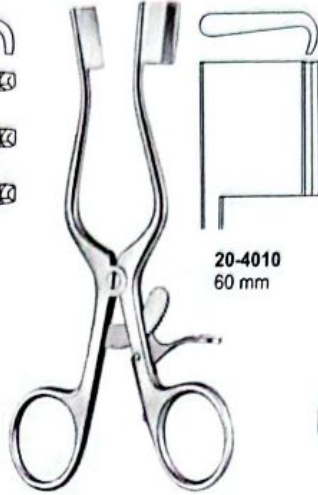

20-4010
60 mm

20-4010
Weitlaner-Baby
13.5 cm



20-4011
18.5 cm

20-4012
16.5 cm

20-4011-20-4012
Henley
16.5 cm



20-4012-20-4019
Adson
14 cm

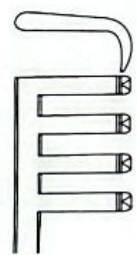

20-4012
14 cm

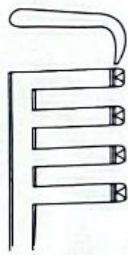

20-4013
16.5 cm

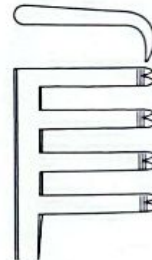

20-4014
21 cm

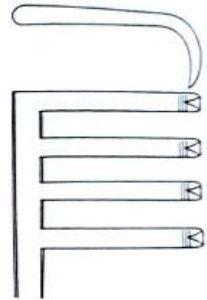

20-4015
24.5 cm

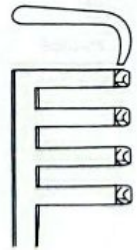

20-4016
14 cm

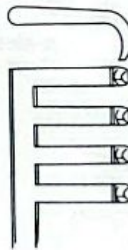

20-4017
16.5 cm

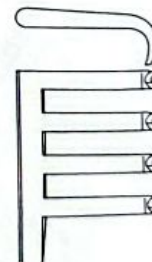

20-4018
21 cm

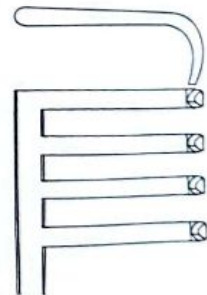

20-4019
24.5 cm



Wound Spreaders, self-retaining



20-4020
Cloward



20-4020
4 cm



20-4021
4.5 cm



20-4022
5 cm



20-4023
5.5 cm



20-4024
6 cm



20-4025-20-4029
Cloward



20-4025
6 cm



20-4026
5.5 cm



20-4027
5 cm



20-4028
4.5 cm



20-4029
4 cm



20-4030
Beckmann
32 cm



20-4030



20-4031
Adson
33 cm

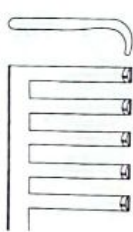

20-4031



20-4032-20-4035
Beckman-Adson



20-4032
31 cm

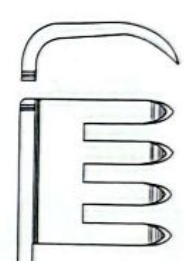

20-4033
31 cm



20-4034
30.5 cm

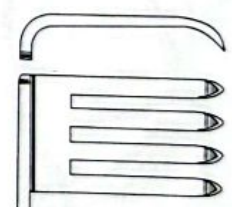

20-4035
30.5 cm



Wound Spreaders, self-retaining



20-4036
Beckman-Eaton
32 cm



20-4037-20-4038
Martin

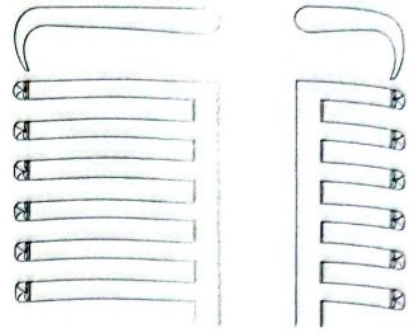

20-4037
28.5 cm

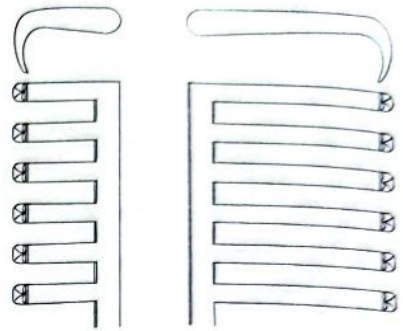

20-4038
28.5 cm



20-4039
Gelpi
13 cm

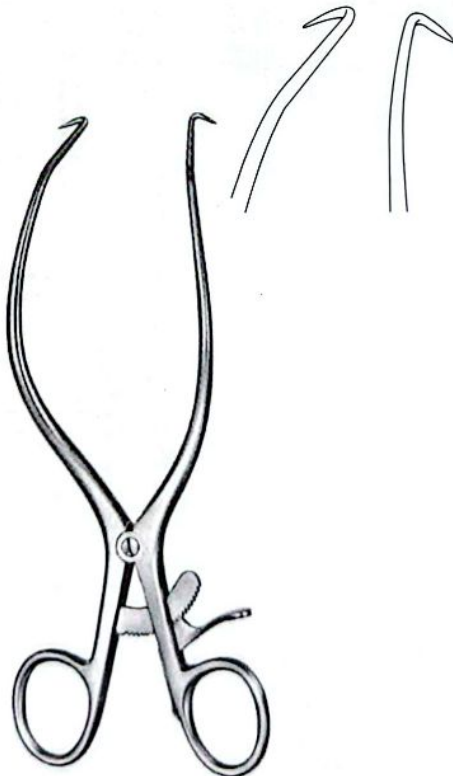

20-4040
Gelpi
18 cm



20-4041
Gelpi
18.5 cm



Wound Spreaders, self-retaining,
Abdominal Retractors



20-4042
Collin, Baby
20 cm
80 mm



20-4043
Collin
22.5 cm
80 mm



20-4044
Collin
24 cm
80 mm



20-4045
Collin
31 cm
130 mm



20-4046-20-4047
Ricard
55 x 70 mm
80 x 90 mm

20-4046

20-4047

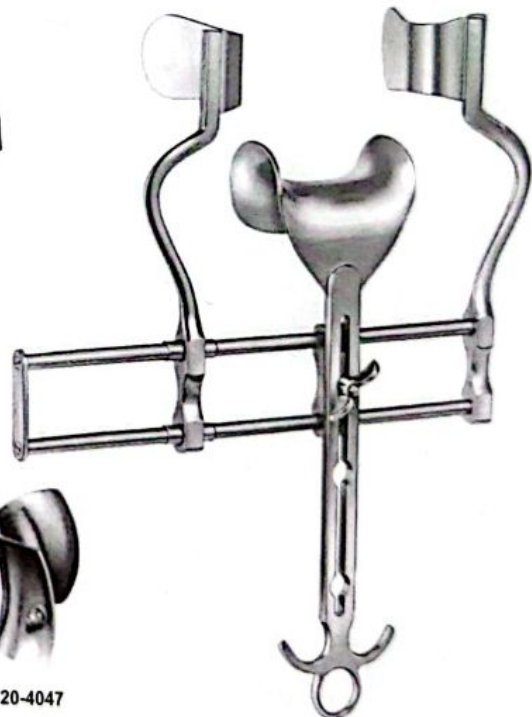

20-4048
Balfour
20 cm



Abdominal Retractors



20-4049
Balfour
20 cm
200 mm



20-4050
Balfour
20 cm
180 mm

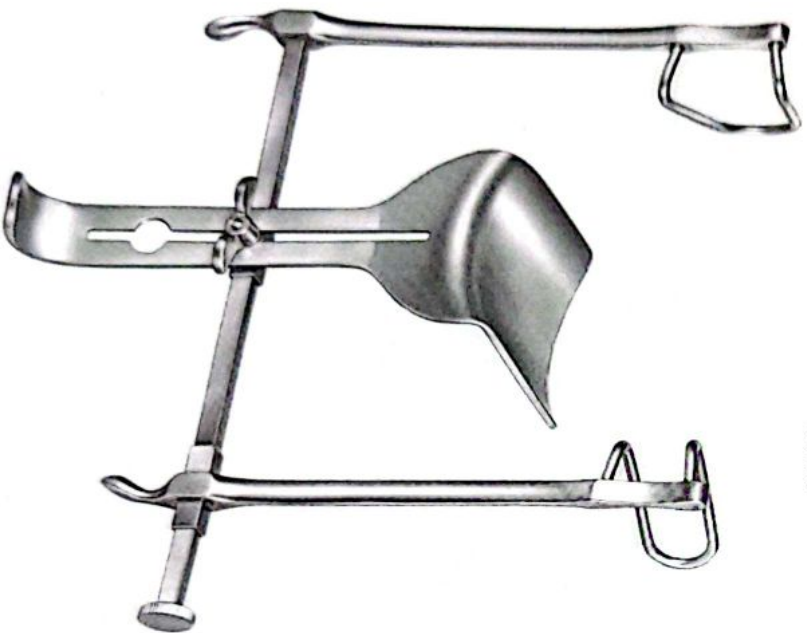

20-4051
Gossel
16,5 cm
160 mm



20-4052
Gossel-Baby
12,5 cm
120 mm



Abdominal Retractors

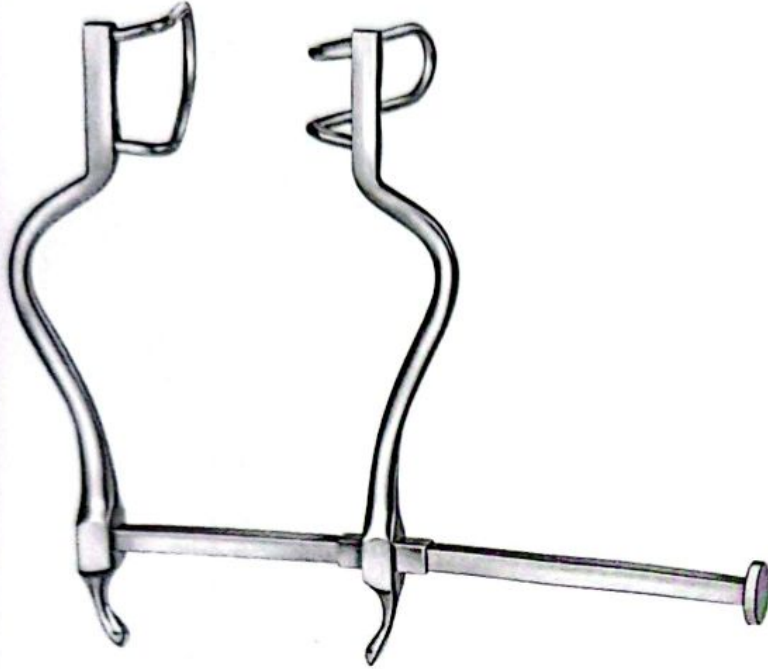

20-4053
Gosset
18.5 cm
140 mm



20-4054
Balfour-Baby
18.5 cm
95 mm

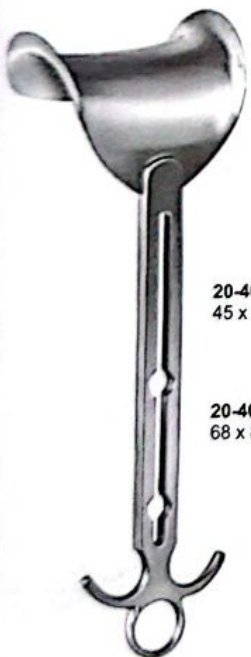

20-4055
45 x 80 mm

20-4056
68 x 85 mm

20-4055-20-4056
Balfour



20-4057
40 x 68 mm

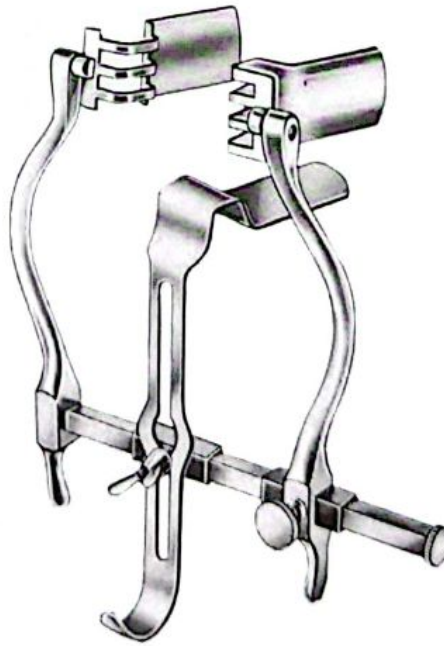

20-4058
Judd-Masson

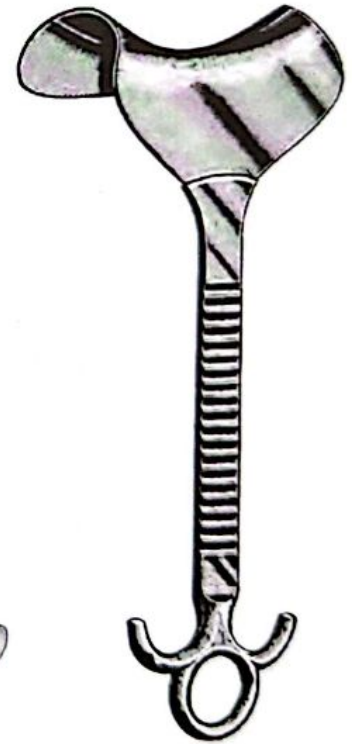

20-4059
Doyen
45 x 95 mm
55 x 105 mm



Abdominal Retractors

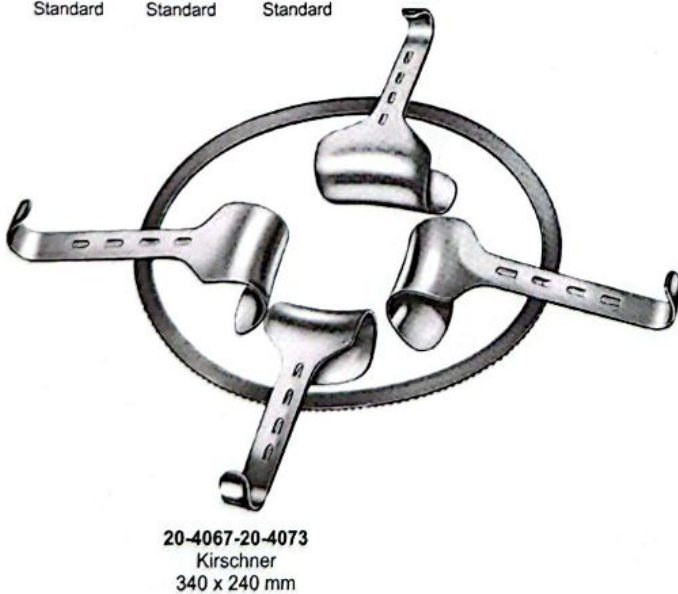
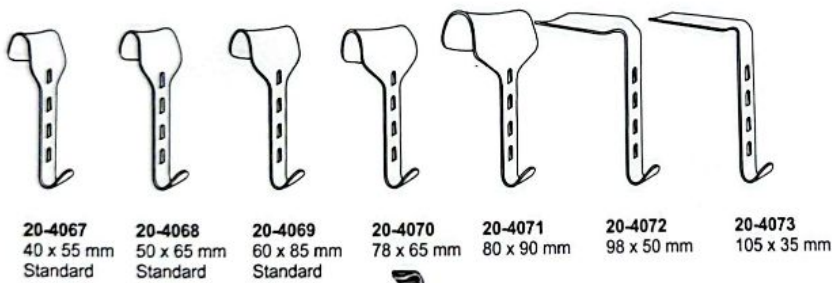
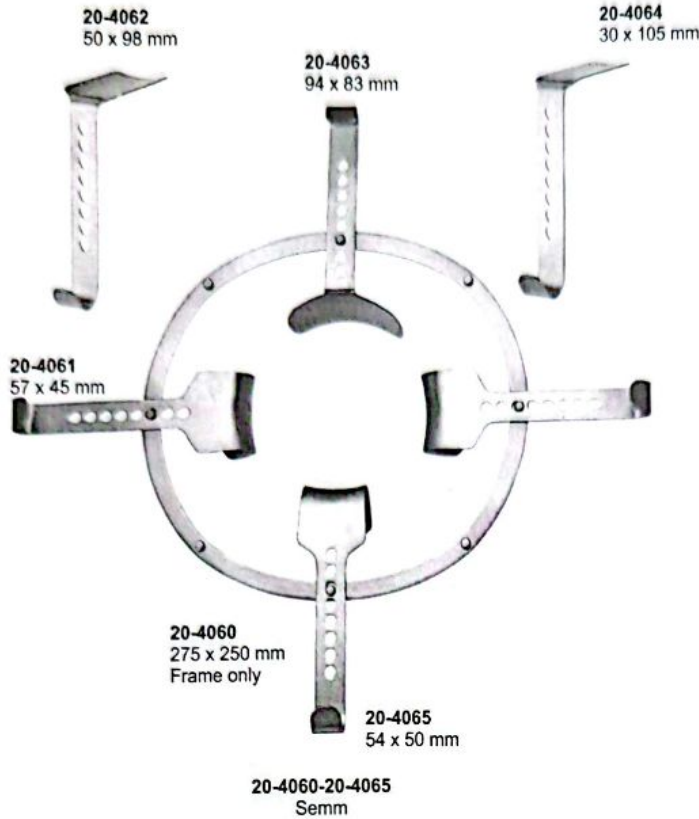

Milium Knife, Lupus Instruments



21-4100
13 cm



21-4101



21-4100-21-4101
Moncorps



21-4102
Vidal
13 cm



21-4103
Fig. 1



21-4104
Fig. 2



21-4105
Fig. 3



21-4106
Fig. 4

21-4103-21-4106
Fox
14 cm



21-4107-21-4112
Wolff
14 cm



21-4107
Fig. 1



21-4108
Fig. 2



21-4109
Fig. 3



21-4110
Fig. 4



21-4111
Fig. 5



21-4112
Fig. 6

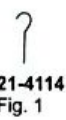

21-4114
Fig. 1

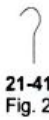

21-4115
Fig. 2



21-4113
Kilner
14.5 cm



21-4114-21-4115
Gillies
18 cm



21-4116-21-4122
Keyes
11 cm



21-4116
Ø 2.0 mm



21-4117
Ø 3.0 mm



21-4118
Ø 4.0 mm



21-4119
Ø 5.0 mm



21-4120
Ø 6.0 mm



21-4121
Ø 7.0 mm



21-4122
Ø 8.0 mm



21-4123
Unna
14.5 cm



Milium Knife, Lupus Instruments



21-4124
Unna
14 cm



21-4125
Saalfeld
11 cm

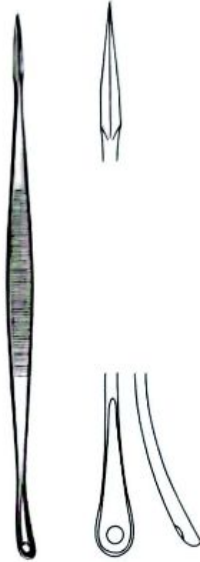

21-4126
Saalfeld
14.5 cm



21-4127
Schamberg
9.5 cm



21-4128
Katsch
16 cm

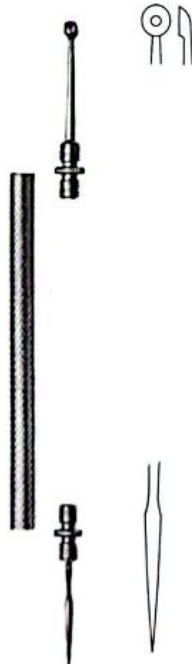

21-4129
Unna-Vidal
11 cm



21-4130
Gillesberger
14.5 cm



21-4130-21-4132
Piffard
14.5 cm

21-4130
Fig. 1

21-4131
Fig. 2

21-4132
Fig. 3

Tracheal Dilators

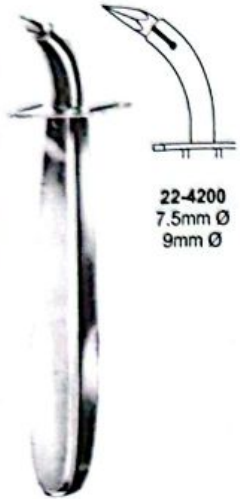

22-4200
7.5mm Ø
9mm Ø

22-4200
Uckermann
13 cm

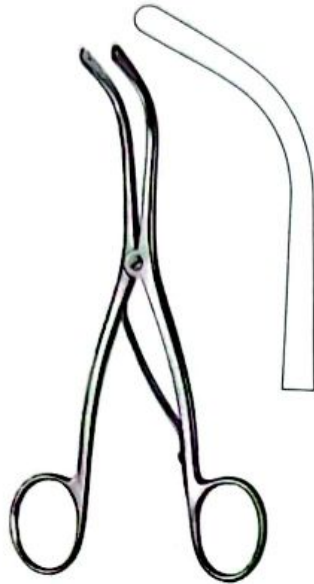

22-4201
Trousseau
14.5 cm



22-4202
Laborde
14 cm



22-4203
Weerda
19 cm



22-4204
Bose
7 cm

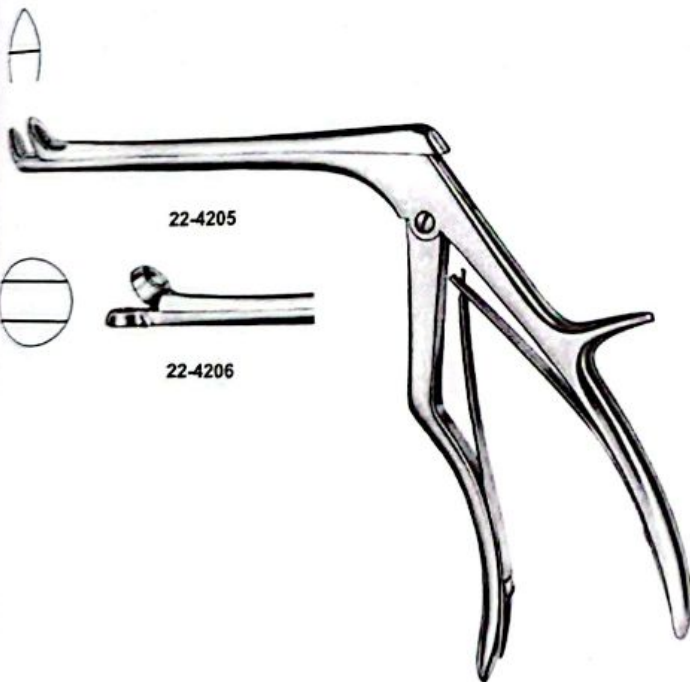

22-4205

22-4206



22-4207
Rose
15.5 cm

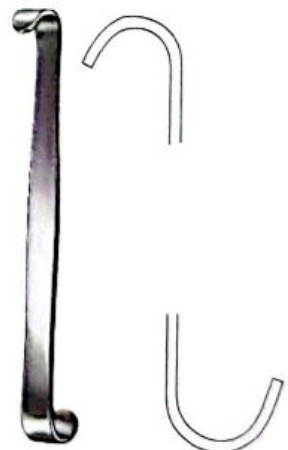

22-4208
Luer
11 cm

Tracheal Dilators, Tracheal Hooks, Tracheal Tubes



22-4209
Jackson
15 cm



22-4210
15 cm



22-4211-22-4212
Iterson

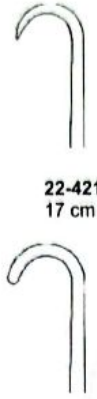

22-4211
17 cm



22-4212
17 cm



22-4213
Bose
16 cm



left



22-4214
Bose
16 cm



right



22-4215
Lukens
17.5 cm



22-4216
26 cm

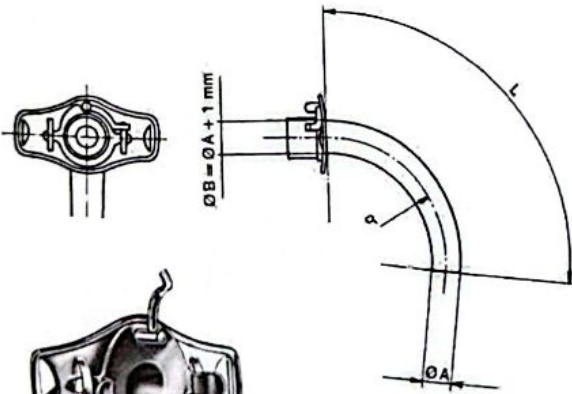

22-4217
Luer

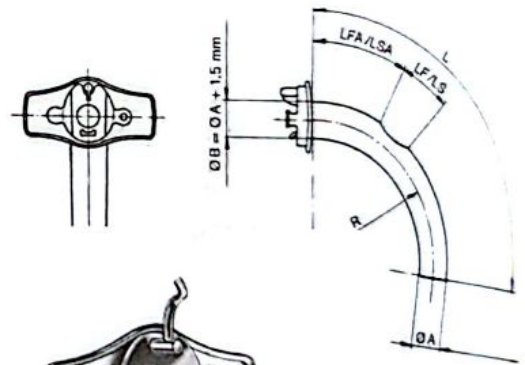

22-4218
Luer



Tracheal Tubes, Speaking Tubes

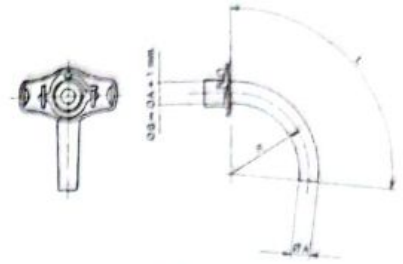
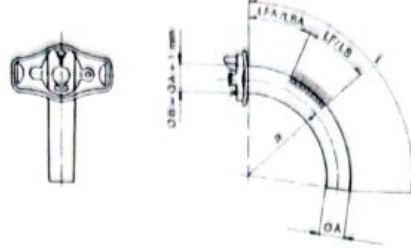
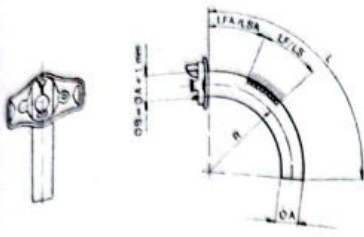

22-4219
Luer

22-4220
Luer

22-4221
Luer

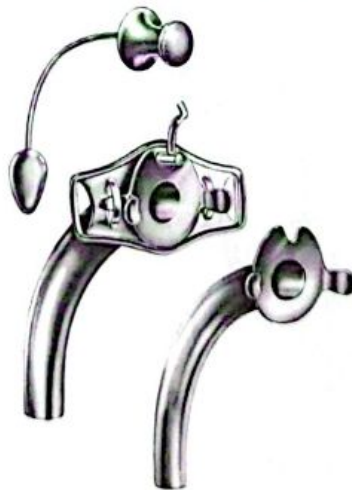
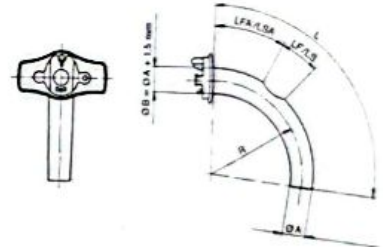
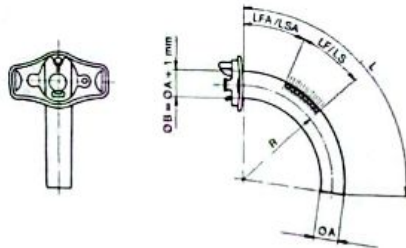
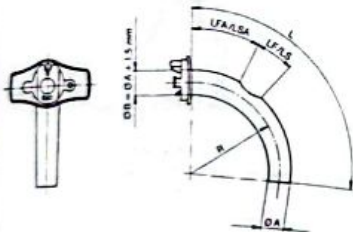

22-4222
Chevalier-Jackson

22-4223
Chevalier-Jackson

22-4224
Speaking Tubes



Eye Speculas



23-4300
Children
7 cm
Weiss



23-4301
Children
9 cm



23-4302
Children
7 cm
Weiss



23-4303
Children
9 cm

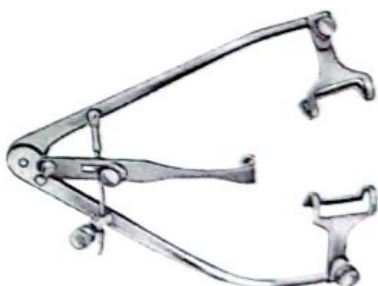

23-4304
Park
8 cm



23-4305
Park-Guyton
8 cm

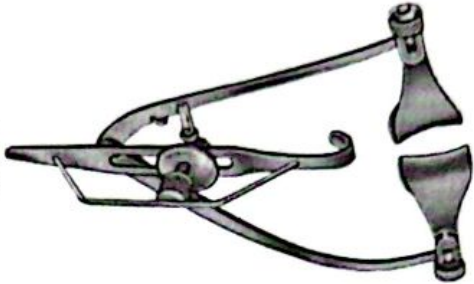

23-4306
Park-Maumenee
8 cm



Barraquer (Colibri)
23-4307 23-4308
Children Adults
3 cm 4 cm



23-4309
Barraquer
4 cm

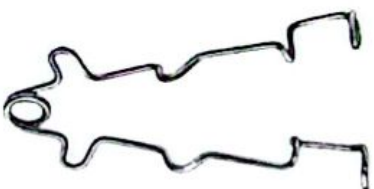

23-4310
Bowman
7 cm



23-4311
Sauer
3 cm



23-4312
Goldstein
3 cm



23-4313
Pley
41 cm

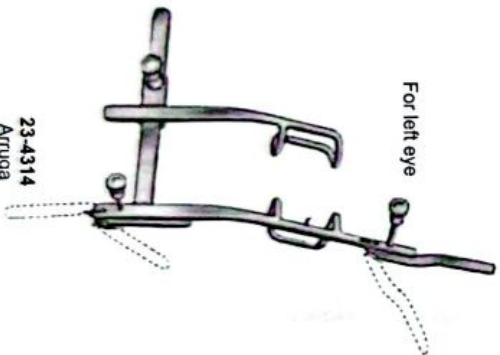

23-4314
Arruga
7 cm

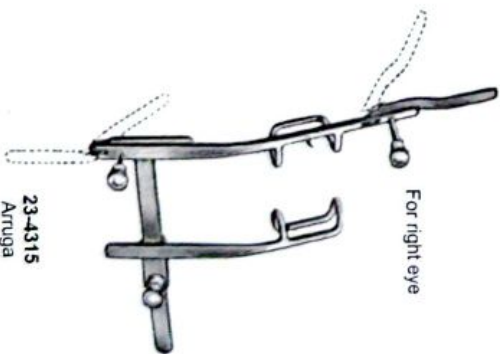

23-4315
Arruga
7 cm



Eye Speculals



23-4316
Mellinger-Axenfeld
7 cm



23-4317
Mellinger-Axenfeld
7 cm



23-4318 Mellinger
Children
5 cm



23-4320 Mellinger Beard
Adults
7 cm



23-4322
Mellinger-Axenfeld
7 cm

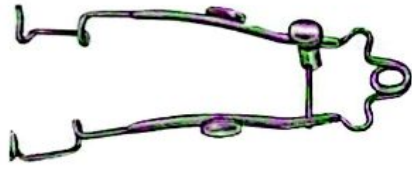

23-4323 Mellinger
Children
6 cm



23-4325
Lancaster
8 cm



23-4326 Williams
Adults
8 cm



23-4328
Lister-Burch
8 cm

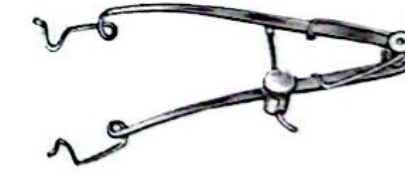

23-4329
Weiss
8 cm



23-4330
Murdock
5 cm



23-4331
Mueller
7 cm



23-4332
Critchett
6 cm



23-4333
Castroviejo
8 cm



Eye Speculas



23-4334
Graefe
0.8 mm



23-4335



23-4336
Weber



23-4337



23-4338
Bowman
0.4 mm



23-4339
Bowman
0.5 mm



23-4340
Bowman
0.6 mm



23-4341
Ziegler
0.7 mm



23-4334-23-4349
Mod. Hamburg



23-4342
Bowman
0.8 mm

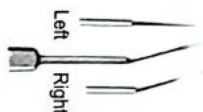

23-4343
Bowman



23-4344
Knapp



23-4345
Knapp



23-4346
Knapp



23-4347
Ziegler
5 mm



23-4348
Ziegler
6 mm



23-4349
Ziegler
7 mm



23-4350
Ziegler
3 1/2 mm



23-4351
Sato



23-4352
Sichel



23-4353
Graefe



23-4354
Graefe



23-4355



23-4356
Kuhnert



23-4357



23-4350-23-4365
Mod. Hamburg



23-4358



23-4359
Paton



23-4360
Eisching



23-4361
Took



23-4362
Desmarres



23-4363
Desmarres



23-4364
Desmarres



23-4365
Gill



Calipers, Markers, Punches Chisels



23-4366
Castroviejo



23-4367
Castroviejo
20 cm



23-4368
Holth



23-4369
Hartz



23-4370
West
16 cm



23-4371
West
16 cm



23-4372
Connin-Amsler
13 cm



23-4373
Wilder



23-4374
Wilder



23-4375
Wilder



Suture Forceps, Trochoma and Chalazion Forceps



23-4376
Tuebinger
10 cm



23-4377
8.5 cm



23-4378
Paufigue
10 cm



23-4379
Barraguer
10.5 cm



23-4380
McPherson
10 cm



23-4381
McPherson
7.5 cm



23-4382
Knapp
11 cm



23-4383
Ayer
9 cm

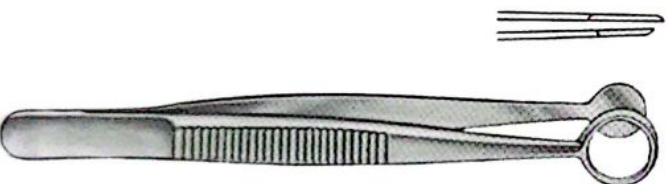

23-4384
Ayer
9 cm



23-4385
Lambert
9 cm



23-4386-23-4388
Desmarres
9 cm



23-4386

23-4387

23-4388



Iridectomy Scissors

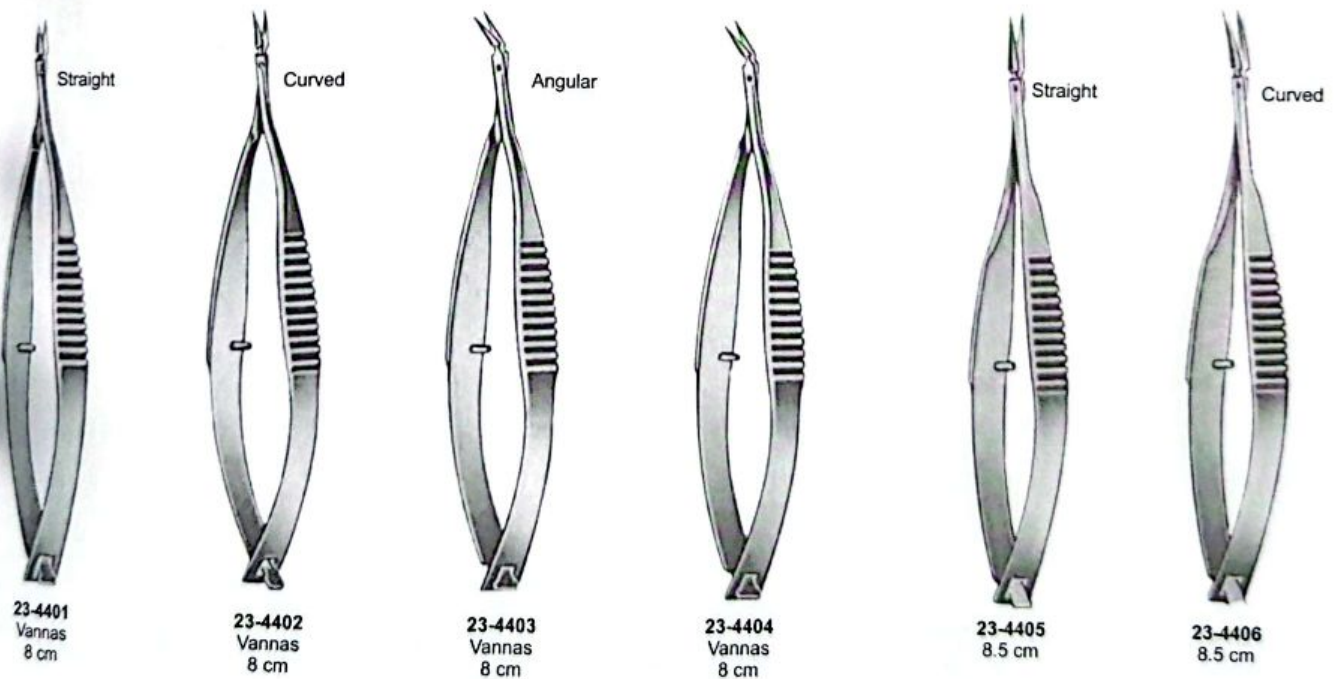
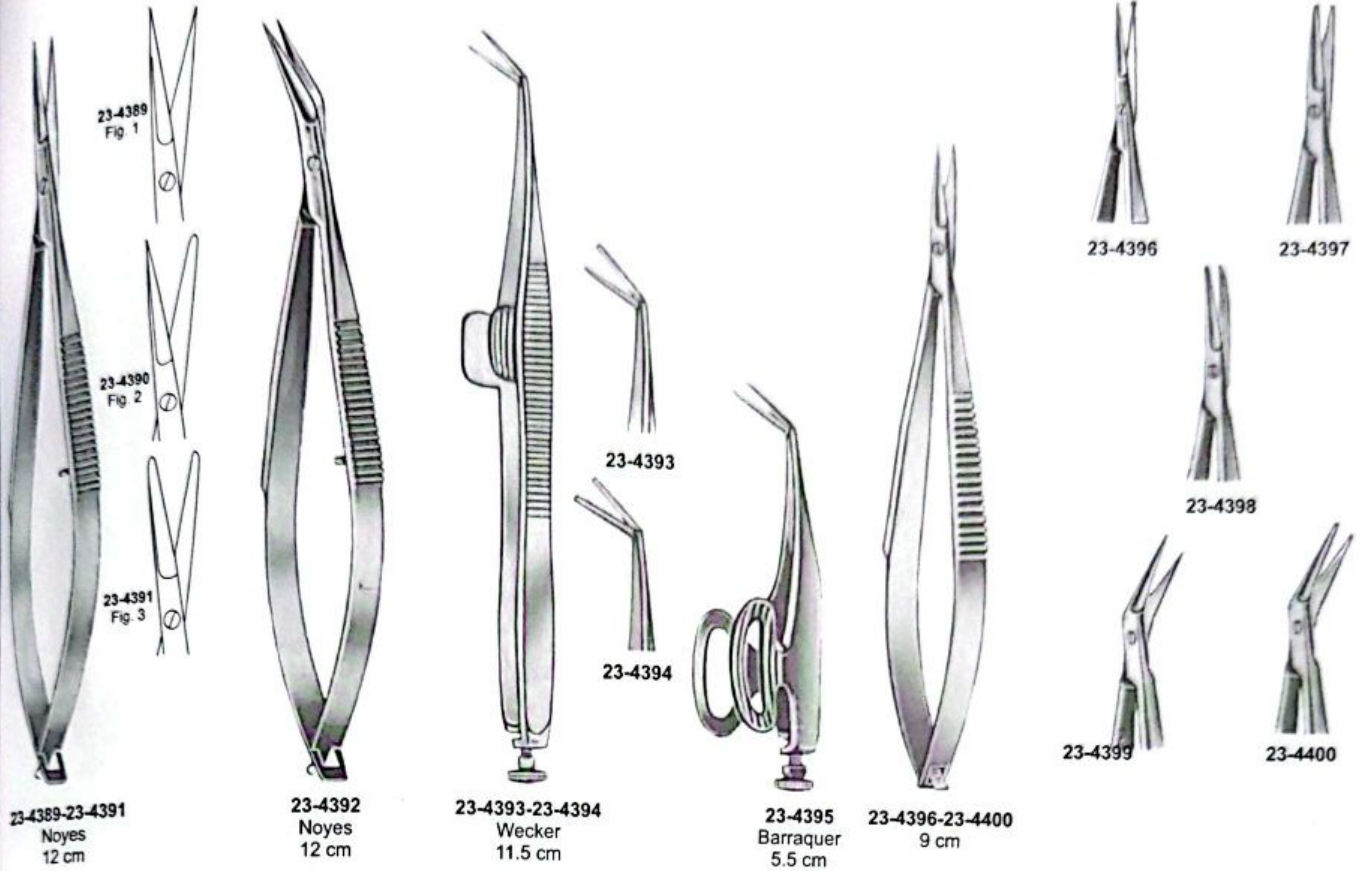

Iridectomy Scissors

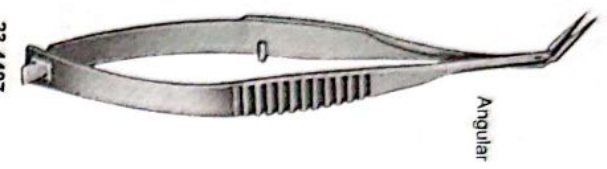

23-4407
8.5 cm

Angular

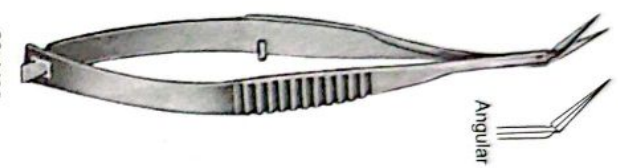

23-4408
8.5 cm

Angular



23-4409
10 cm



23-4410
10 cm



23-4411
10 cm



23-4412
10 cm

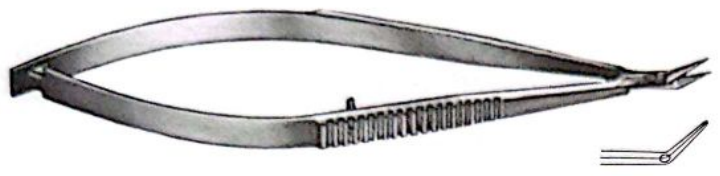

23-4413
10 cm

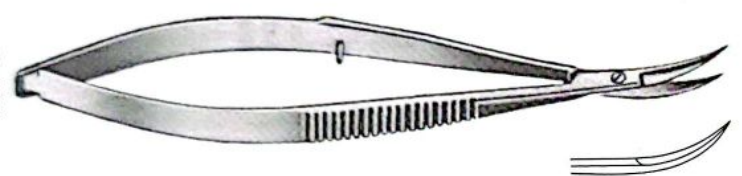

23-4414
10 cm

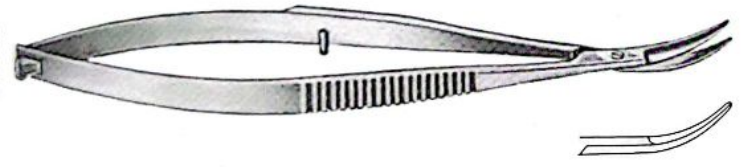

23-4415
10 cm

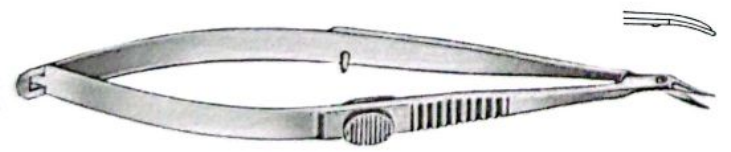

23-4416
10 cm



23-4417
10 cm



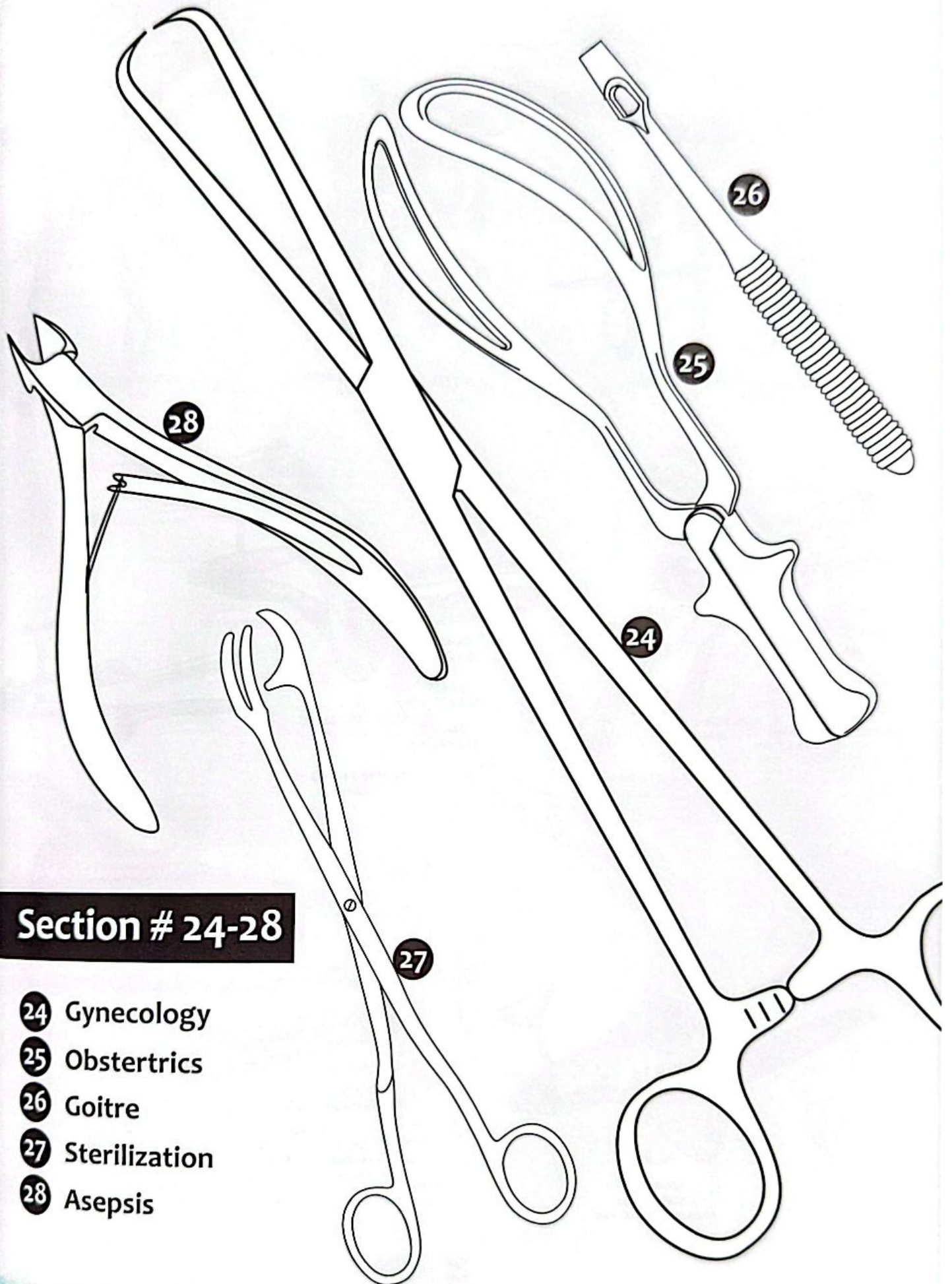

Section # 24-28

- 24** Gynecology
- 25** Obstetrics
- 26** Goitre
- 27** Sterilization
- 28** Asepsis

Vaginal Specula

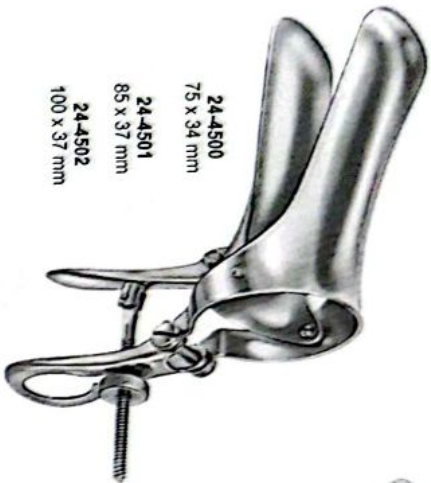

24-4500
75 x 34 mm
24-4501
85 x 37 mm
24-4502
100 x 37 mm

24-4500-24-4502
Cusco

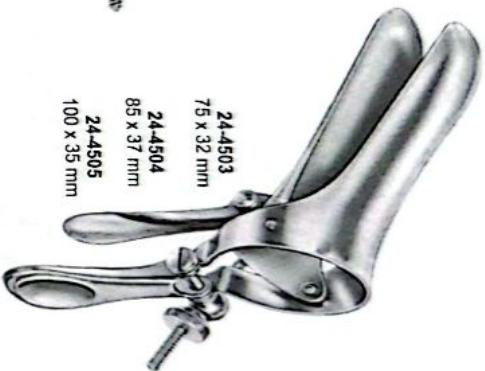

24-4503
75 x 32 mm
24-4504
85 x 37 mm
24-4505
100 x 35 mm

24-4503-24-4505
Cusco



24-4506
Cusco
75 x 18 mm

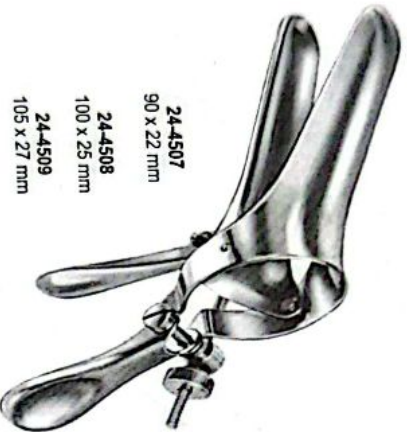

24-4507
90 x 22 mm
24-4508
100 x 25 mm
24-4509
105 x 27 mm

24-4507-24-4509
Cusco

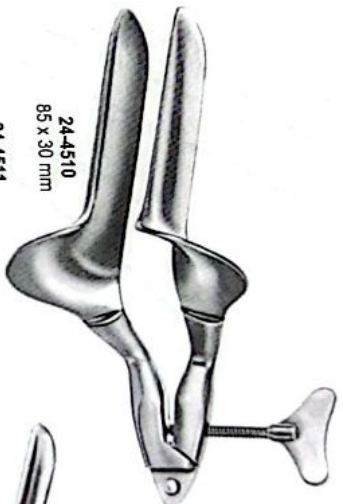

24-4510
85 x 30 mm
24-4511
100 x 35 mm
24-4512
110 x 40 mm

24-4510-24-4512
Collin



24-4513
Collin
65 x 20mm



for children
24-4517
Collin
55 x 10mm

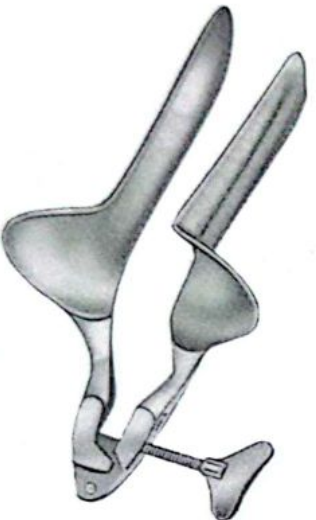

24-4514
Collin-Landau
Medium 35 x 100 mm



24-4515
Small 30 x 85 mm
Medium 35 x 100 mm
Large 40 x 110 mm

24-4516
Collin



Vaginal Specula

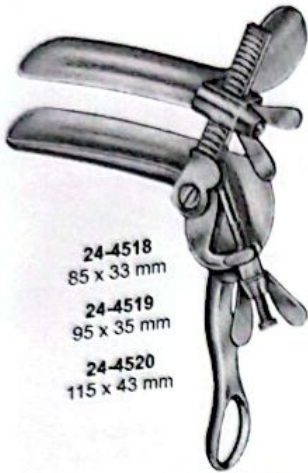

24-4518
85 x 33 mm
24-4519
95 x 35 mm
24-4520
115 x 43 mm

24-4518-24-4520
Trelat



24-4521
75 x 20 mm
24-4522
95 x 35 mm
24-4523
115 x 35 mm

24-4521-24-4523
Grave

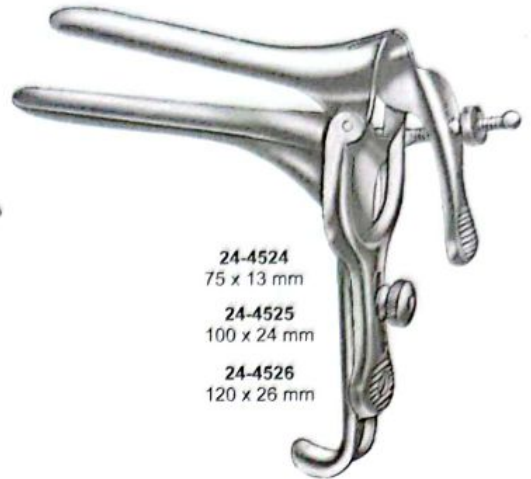

24-4524
75 x 13 mm
24-4525
100 x 24 mm
24-4526
120 x 26 mm

24-4524-24-4526
Pederson



24-4527
100 x 20-25 mm
24-4528
100 x 27-35 mm

24-4527-24-4528
Semm

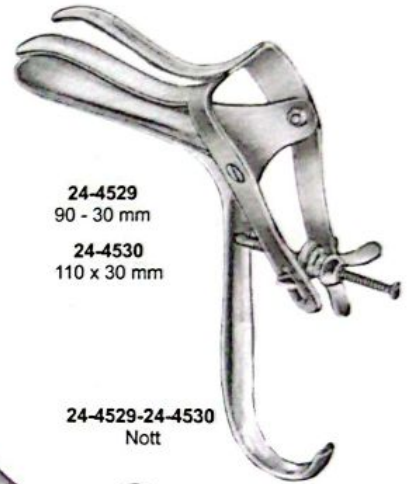

24-4529
90 - 30 mm
24-4530
110 x 30 mm

24-4529-24-4530
Nott

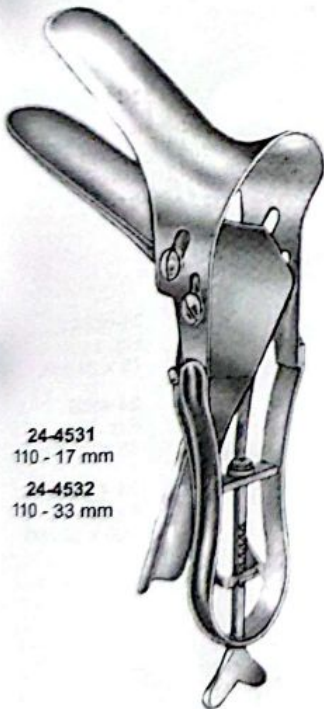

24-4531
110 - 17 mm
24-4532
110 - 33 mm

24-4531-24-4532
Seyffert



24-4533
Sakurai's

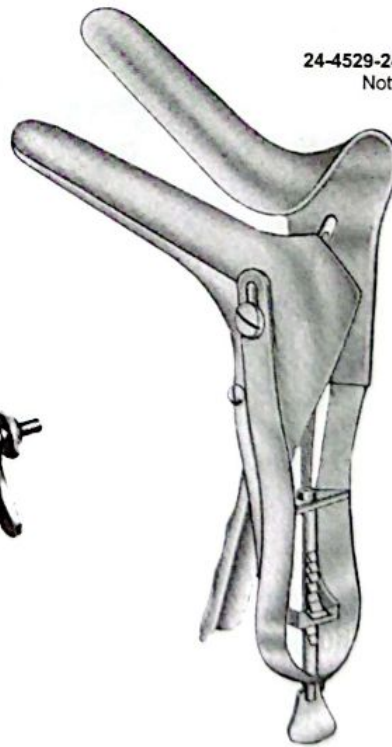

24-4534
110 - 33 mm

24-4534
Seyffert



Vaginal Specula, Vaginal Retractors



24-4535
63 x 32 mm

24-4536
76 x 32 mm

24-4537
89 x 38 mm

24-4535-24-4537
Sims (single ended)



24-4538-24-4540
Sims

24-4538
65 x 25 mm

24-4539
70 x 30 mm

24-4540
85 x 35 mm



24-4541
75 x 38 mm

24-4542
90 x 38 mm

24-4543
100 x 38 mm

24-4541-24-4543
Jackson



24-4544
Fig. 1
75 X 35 mm

24-4545
Fig. 2
90 X 35 mm

24-4546
Fig. 3
100 X 35 mm

24-4547
Fig. 4
100 X 35 mm

24-4548
Fig. 4
75 X 40 mm

24-4549
Fig. 5
90 x 40 mm

24-4550
Fig. 5
100 x 40 mm

24-4544-24-4550
Eastman

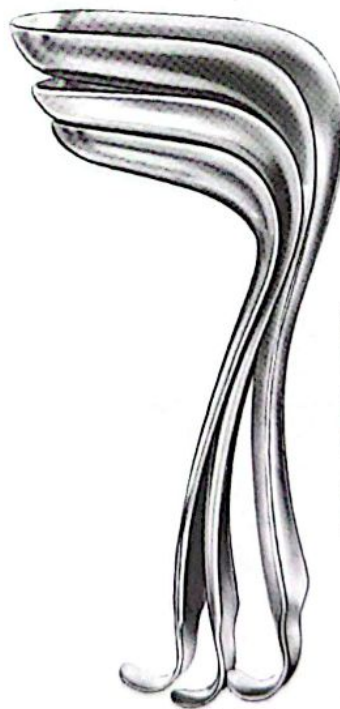

24-4551-24-4553
Kristeller

24-4551
Fig. 1
70 x 27 mm

24-4552
Fig. 2
80 x 30 mm

24-4553
Fig. 3
90 x 36 mm



24-4554-24-4556
Kristeller

24-4554
Fig. 1
75 x 23 mm

24-4555
Fig. 2
85 x 26 mm

24-4556
Fig. 3
100 x 32 mm



Vaginal Specula, Vaginal Retractors



24-4557
Fig. 1

24-4558
Fig. 2

24-4559
Fig. 3

24-4557-24-4559
Kristeller



24-4560
Fig. 1
105 x 18 mm

24-4561
Fig. 2
110 x 21 mm

24-4560-24-4561
Kristeller



24-4562
Fig. 1
110 x 14 mm

24-4563
Fig. 2
115 x 17 mm

24-4562-24-4563
Kristeller



24-4564
Fig. 1

24-4565
Fig. 2

24-4564-24-4565
Kristeller

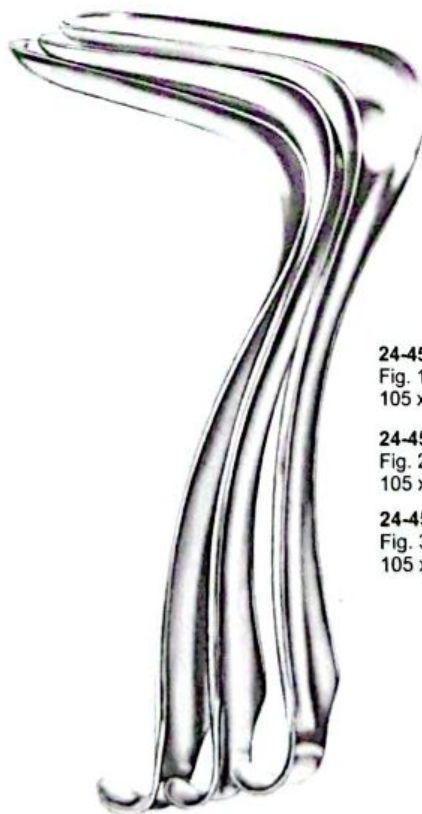

24-4566
Fig. 1
105 x 26 mm

24-4567
Fig. 2
105 x 28 mm

24-4568
Fig. 3
105 x 33 mm

24-4566-24-4568
Kristeller

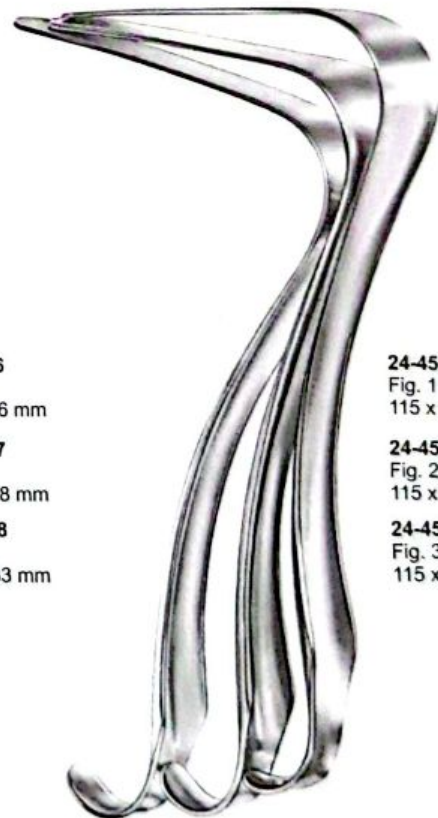

24-4569
Fig. 1
115 x 22 mm

24-4570
Fig. 2
115 x 24 mm

24-4571
Fig. 3
115 x 29 mm

24-4569-24-4571
Kristeller



Vaginal Specula, Vaginal Retractors



24-4572
Fig. 1

24-4573
Fig. 2

24-4574
Fig. 3

24-4572-24-4574
Kristeller



24-4575
Fig. 1
110 x 28 mm

24-4576
Fig. 2
110 x 30 mm

24-4577
Fig. 3
110 x 36 mm

24-4575-24-4577
Kristeller

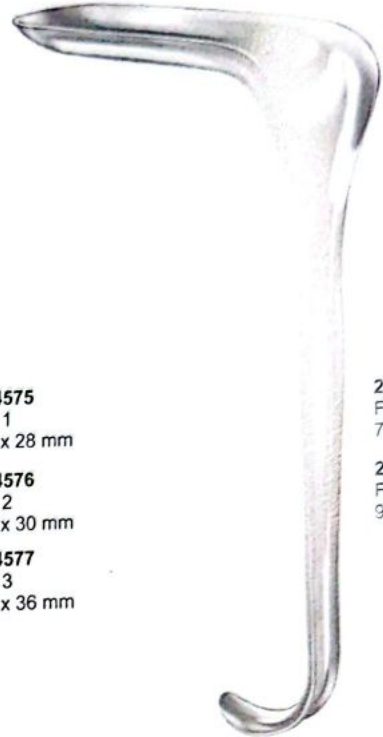

24-4578
Fig. 1
70 x 40 mm

24-4579
Fig. 2
90 x 40 mm

24-4578-24-4579
Kallmorgen



24-4580
Fig. 1
70 x 37 mm

24-4581
Fig. 2
90 x 37 mm

24-4580-24-4581
Kallmorgen



24-4582
Fig. 1

24-4583
Fig. 2

24-4582-24-4583
Kallmorgen



24-4584
Fig. 1
58 x 35 mm

24-4585
Fig. 2
88 x 35 mm

24-4586
Fig. 3
118 x 35 mm

24-4587
Fig. 1
60 x 47 mm

24-4588
Fig. 2
78 x 47 mm

24-4589
Fig. 3
120 x 47 mm

24-4590
Fig. 4
165 x 47 mm

24-4591
Fig. 1
55 x 60 mm

24-4592
Fig. 2
85 x 60 mm

24-4593
Fig. 3
115 x 60 mm

24-4584-24-4593
Doyen

Vaginal Specula, Vaginal Retractors,
Uterine Dilators



24-4594
Auvard
23.5 cm

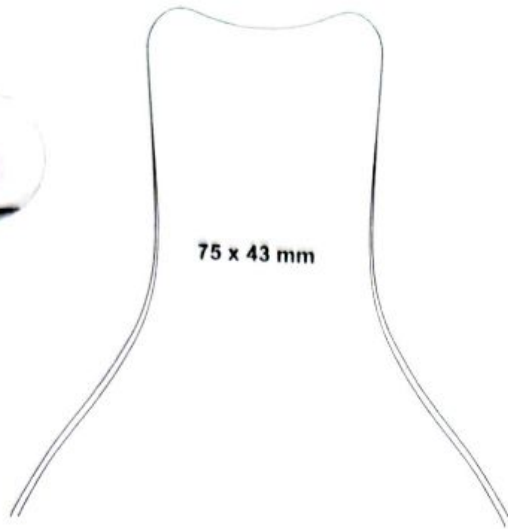

75 x 43 mm



24-4595
Auvard
80 x 38 mm



- 24-4596
29.5 cm
100 x 20 mm
- 24-4597
29.5 cm
100 x 25 mm
- 24-4598
29.5 cm
100 x 30 mm
- 24-4599
29.5 cm
100 x 35 mm
- 24-4600
29.5 cm
100 x 40 mm

24-4596-24-4600
Breisky



24-4601
Doyen
25 cm



24-4602
Hegar
18.5 cm



Vaginal Specula, Vaginal Retractors,
Uterine Dilators



24-4603
Hegar
20 cm



24-4604
Hegar

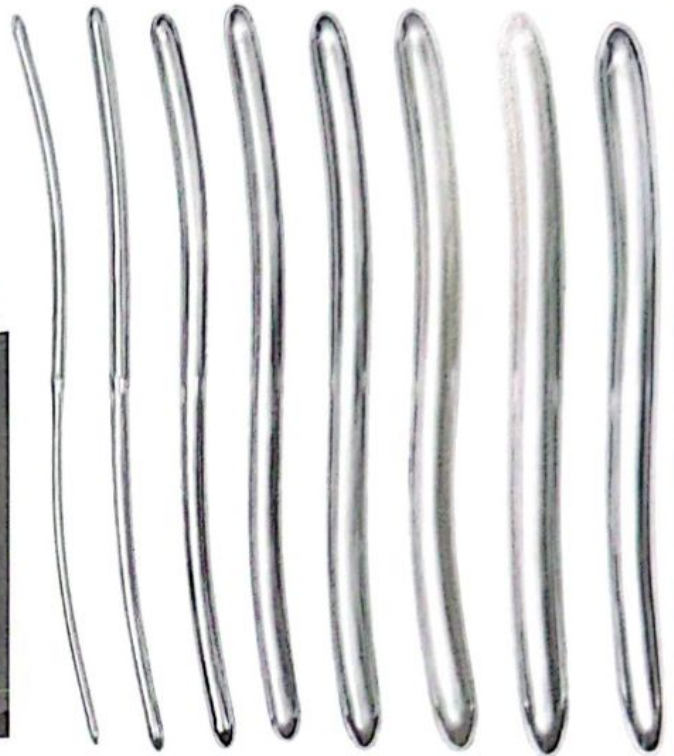

24-4605
Hegar



24-4606
Hank
26.5 cm



24-4607
Hank



Fistula Hooks, Myoma Screws, Myoma Knife



24-4608
Ayre
23.5 cm



24-4609
Simon
21.5 cm



24-4610
Simon
21.5 cm



24-4611
Emmett
Fig. 3
23 cm



24-4612
Doyen
17 cm
Ø 20 mm



24-4613
Doyen
15 cm
Ø 29 mm



24-4614
Segond
28 cm



Uterine Biopsy Forceps, IUP Grasping Forceps

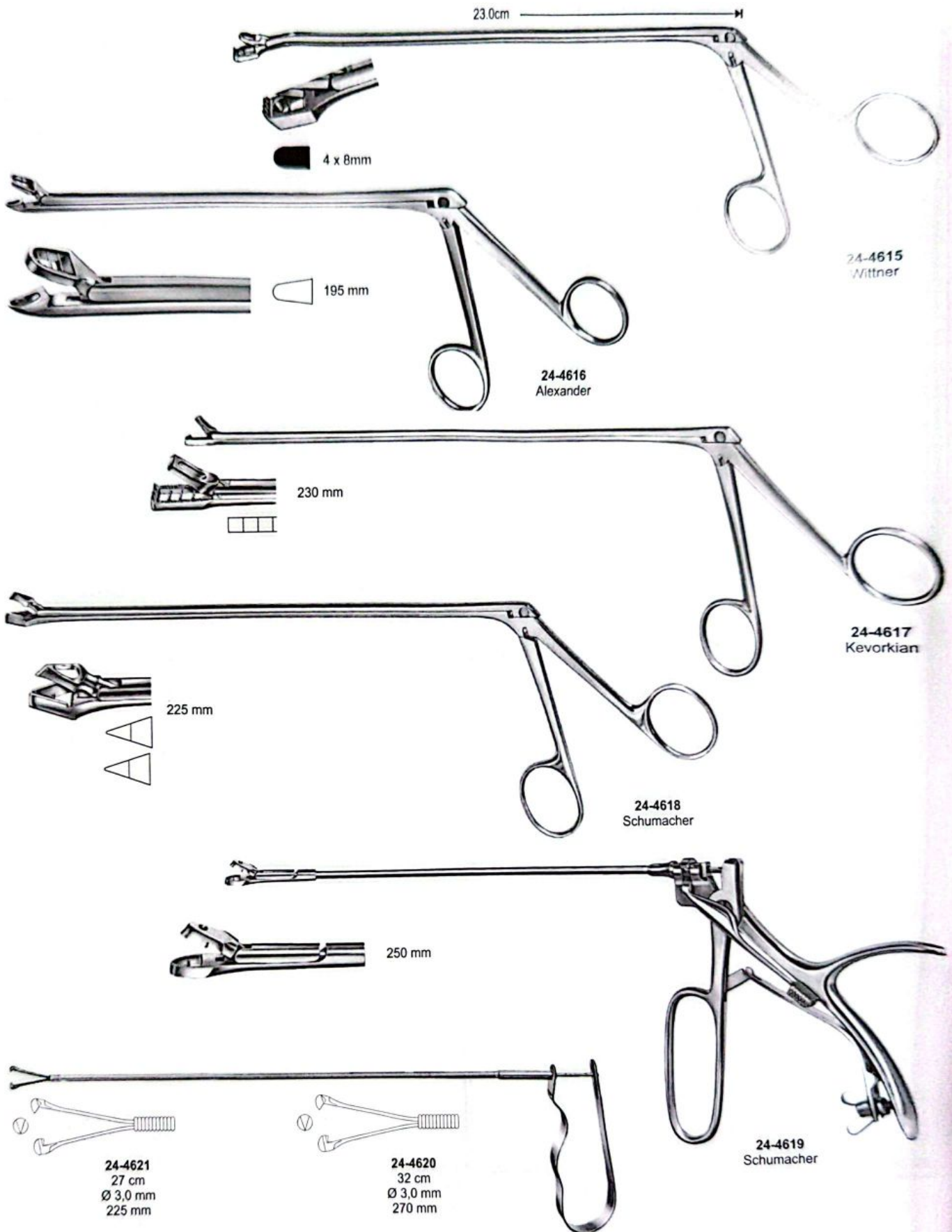

Uterine Scoops, Uterine Curettes, Uterine Tenaculum Forceps, Amniotome

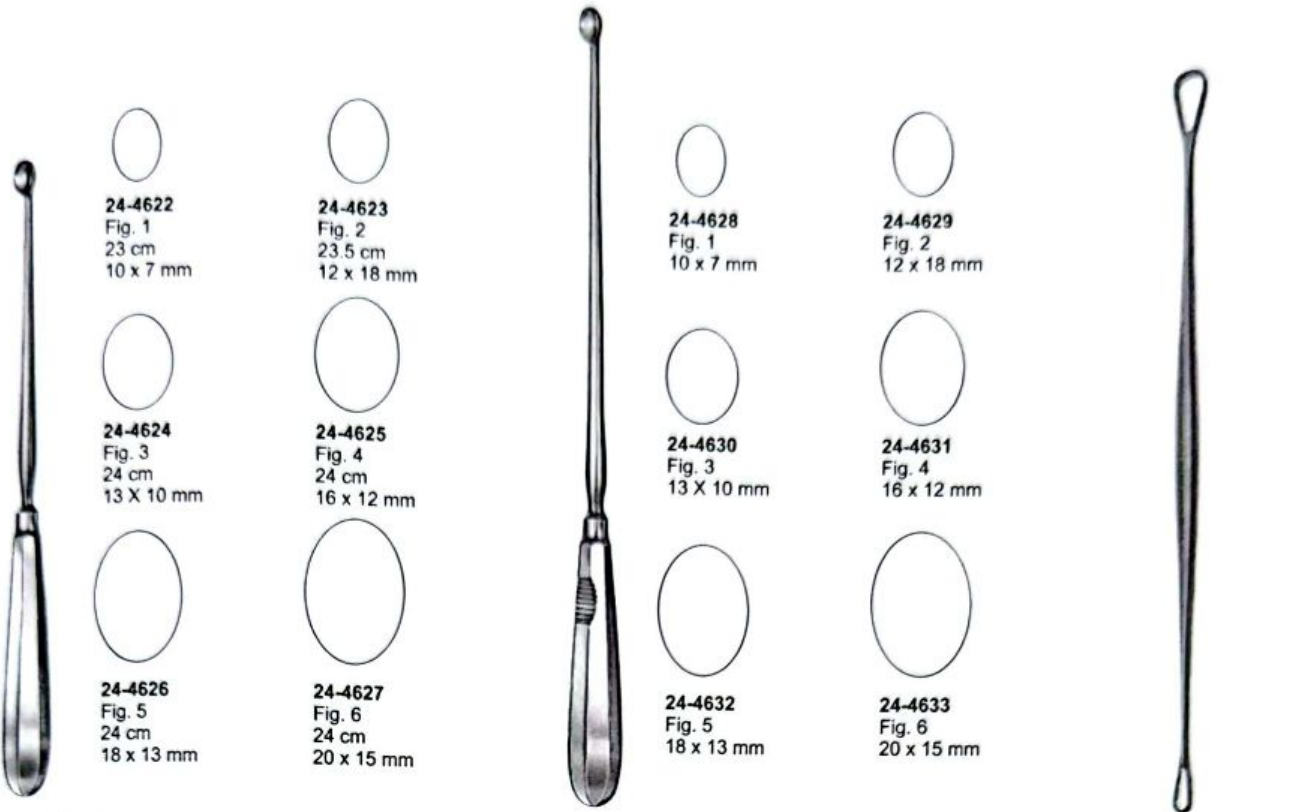

24-4622
Fig. 1
23 cm
10 x 7 mm

24-4623
Fig. 2
23.5 cm
12 x 18 mm

24-4628
Fig. 1
10 x 7 mm

24-4629
Fig. 2
12 x 18 mm

24-4624
Fig. 3
24 cm
13 X 10 mm

24-4625
Fig. 4
24 cm
16 x 12 mm

24-4630
Fig. 3
13 X 10 mm

24-4631
Fig. 4
16 x 12 mm

24-4626
Fig. 5
24 cm
18 x 13 mm

24-4627
Fig. 6
24 cm
20 x 15 mm

24-4632
Fig. 5
18 x 13 mm

24-4633
Fig. 6
20 x 15 mm

24-4622-24-4627
Simon

24-4628-24-4633
Simon
30 cm

24-4634
Blake
27.5 cm
8 mm



24-4635
Schröder
25.5 cm

24-4636
Braun
26 cm

24-4637
Duplay
28 cm

24-4638
Schröder
25 cm

24-4638



Uterine Tenaculum Forceps

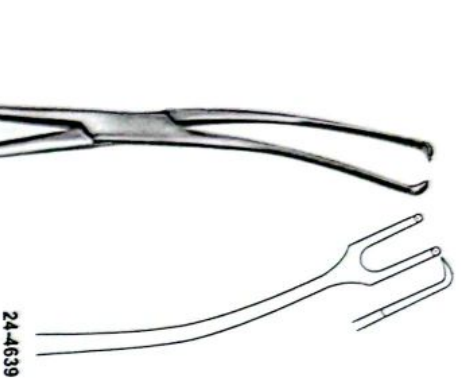

24-4639
Teale
23 cm

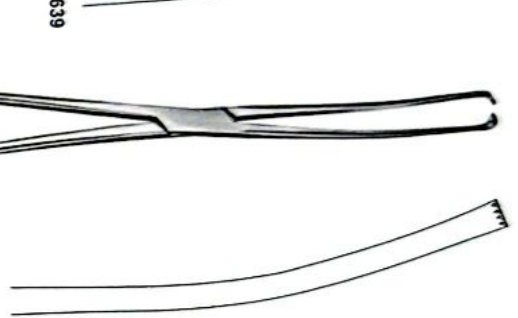

24-4640
Iowa
26 cm

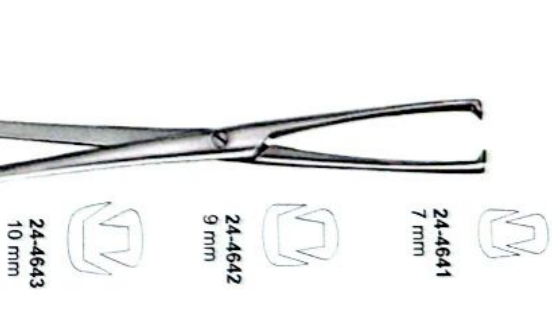

24-4641-24-4643
Museux
24 cm



24-4644
Jacobs
21 cm

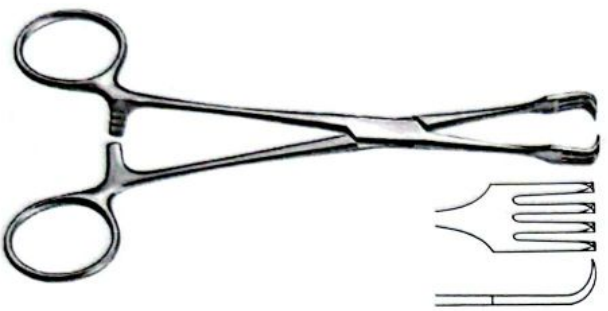

24-4645
Braun
16 cm

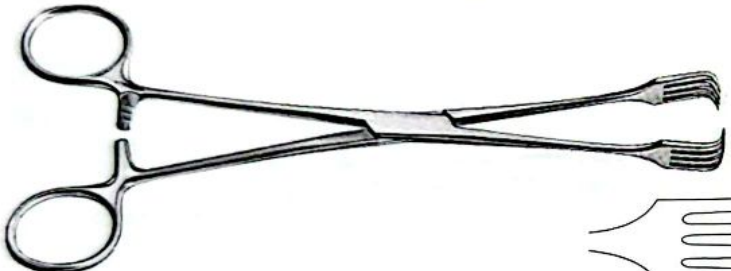

24-4646
Czerny
21 cm

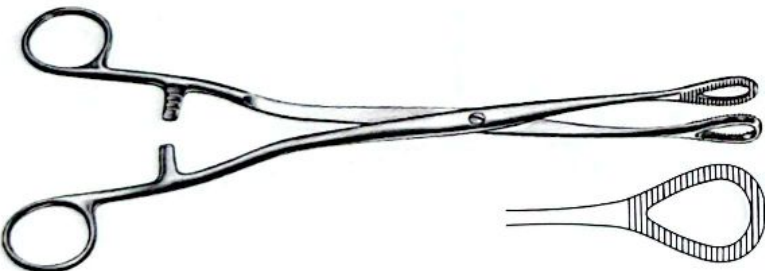
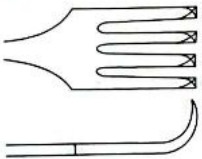

24-4647
Kelly
31.5 cm

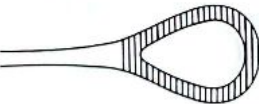

24-4648
Heywood-Smith
26 cm



Uterine Curettes

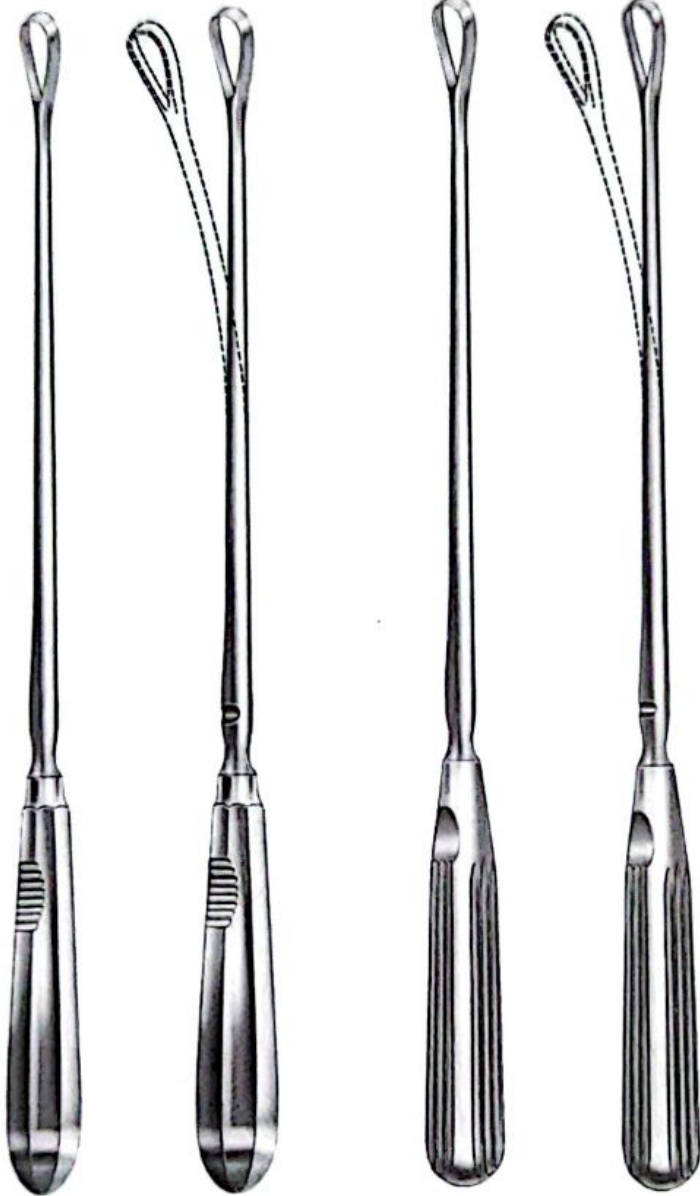

24-4649
Recamier

24-4650
Recamier

24-4651
Sims

24-4652
Sims

sharp, rigid	Fig	width	sharp, malleable
24-4649	Fig. 00	5 mm	24-4650
24-4649-A	Fig. 0	6 mm	24-4650-A
24-4649-B	Fig. 1	7 mm	24-4650-B
24-4649-C	Fig. 2	8 mm	24-4650-C
24-4649-D	Fig. 3	9 mm	24-4650-D
24-4649-E	Fig. 4	11 mm	24-4650-E
24-4649-F	Fig. 5	12 mm	24-4650-F
24-4649-G	Fig. 6	14 mm	24-4650-G
24-4649-H	Fig. 7	15 mm	24-4650-H
24-4649-I	Fig. 8	16 mm	24-4650-I
24-4649-J	Fig. 9	19 mm	24-4650-J
24-4649-K	Fig. 10	20 mm	24-4650-K
24-4649-L	Fig. 11	21 mm	24-4650-L
24-4649-M	Fig. 12	23 mm	24-4650-M
24-4649-N	Fig. 13	25 mm	24-4650-N
24-4649-O	Fig. 14	30 mm	24-4650-O
24-4649-P	Fig. 15	35 mm	24-4650-P
24-4649-Q	Fig. 16	40 mm	24-4650-Q

sharp, rigid	Fig	width	sharp, malleable
24-4651	Fig. 00	5 mm	24-4652
24-4651-A	Fig. 0	6 mm	24-4652-A
24-4651-B	Fig. 1	7 mm	24-4652-B
24-4651-C	Fig. 2	8 mm	24-4652-C
24-4651-D	Fig. 3	9 mm	24-4652-D
24-4651-E	Fig. 4	11 mm	24-4652-E
24-4651-F	Fig. 5	12 mm	24-4652-F
24-4651-G	Fig. 6	14 mm	24-4652-G
24-4651-H	Fig. 7	15 mm	24-4652-H
24-4651-I	Fig. 8	16 mm	24-4652-I
24-4651-J	Fig. 9	19 mm	24-4652-J
24-4651-K	Fig. 10	20 mm	24-4652-K
24-4651-L	Fig. 11	21 mm	24-4652-L
24-4651-M	Fig. 12	23 mm	24-4652-M
24-4651-N	Fig. 13	25 mm	24-4652-N
24-4651-O	Fig. 14	30 mm	24-4652-O
24-4651-P	Fig. 15	35 mm	24-4652-P
24-4651-Q	Fig. 16	40 mm	24-4652-Q



Obstetrical Forceps



25-4700
Wrigley
23 cm
28 cm



25-4701
De-lee
30 cm



25-4702
De-lee
36 cm



25-4703
Simpson
23 cm str
23 cm cvd



25-4704
Simpson
23 cm
30 cm



25-4705
Simpson-braun
23 cm
30 cm



25-4706
Kielland
41 cm

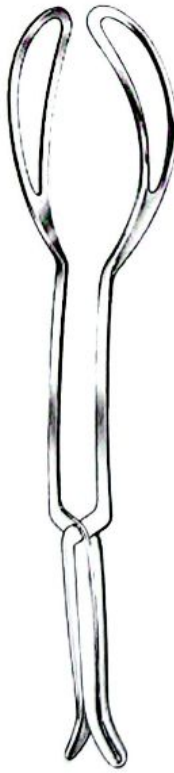

25-4707
Piper
44 cm



25-4708
Elliot
32 cm, 38 cm



25-4709
Naegele
36 cm, 40 cm



25-4710
Kedar Nath Das
33 cm



25-4711
Boerma
33 cm



Obstetrical Forceps, Uterine Haemostasis Forceps and Umbilical Cord Clamps



25-4712
Lafe-piper
30 cm

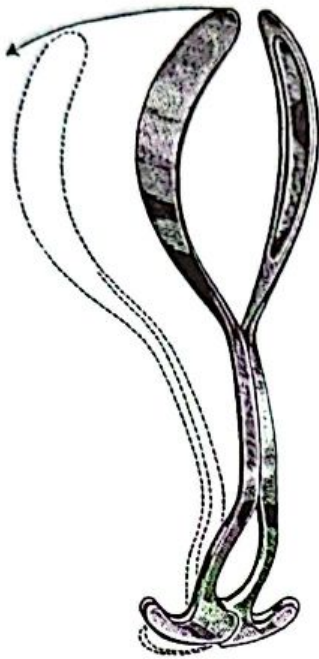

25-4713
Lafe Divergent Outlet
31 cm



25-4714
Green-armytage
21 cm



25-4715
Green-armytage
19.5 cm



25-4716
Gauss
26 cm



25-4717
Saenger
27 cm



25-4718
Sellheim
28 cm

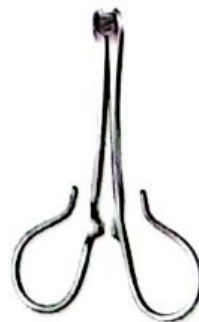

25-4719
Kane
8.5 cm



25-4720
Collin
9 cm



Placenta and Ovum forceps, Ovum Curettes, Abortion Scoops



25-4721
Heywood-smith
25 cm



25-4722
Corey
24 cm



25-4723
Willet
19 cm



25-4724-25-4726
Winter
28 cm



25-4724
Fig. 1



25-4725
Fig. 2



25-4726
Fig. 3



25-4727
Winter-nassauer
28 cm



25-4728
Spackmann
35 cm



25-4729
Spackmann
35 cm



25-4730
Leech-wilkinson
26.5 cm



25-4730
Ø 10 x 25mm
small



25-4731
Ø 13 x 30mm
medium



25-4732
Ø 16 x 30mm
large



toothed back



25-4733-25-4735
Cuzzi
30 cm, blunt



25-4733
14.5 mm



25-4734
18 mm



25-4735
21 mm



Ovum Currettes, Abortion Scoops, Aspirating Currettes, Pelvimeters

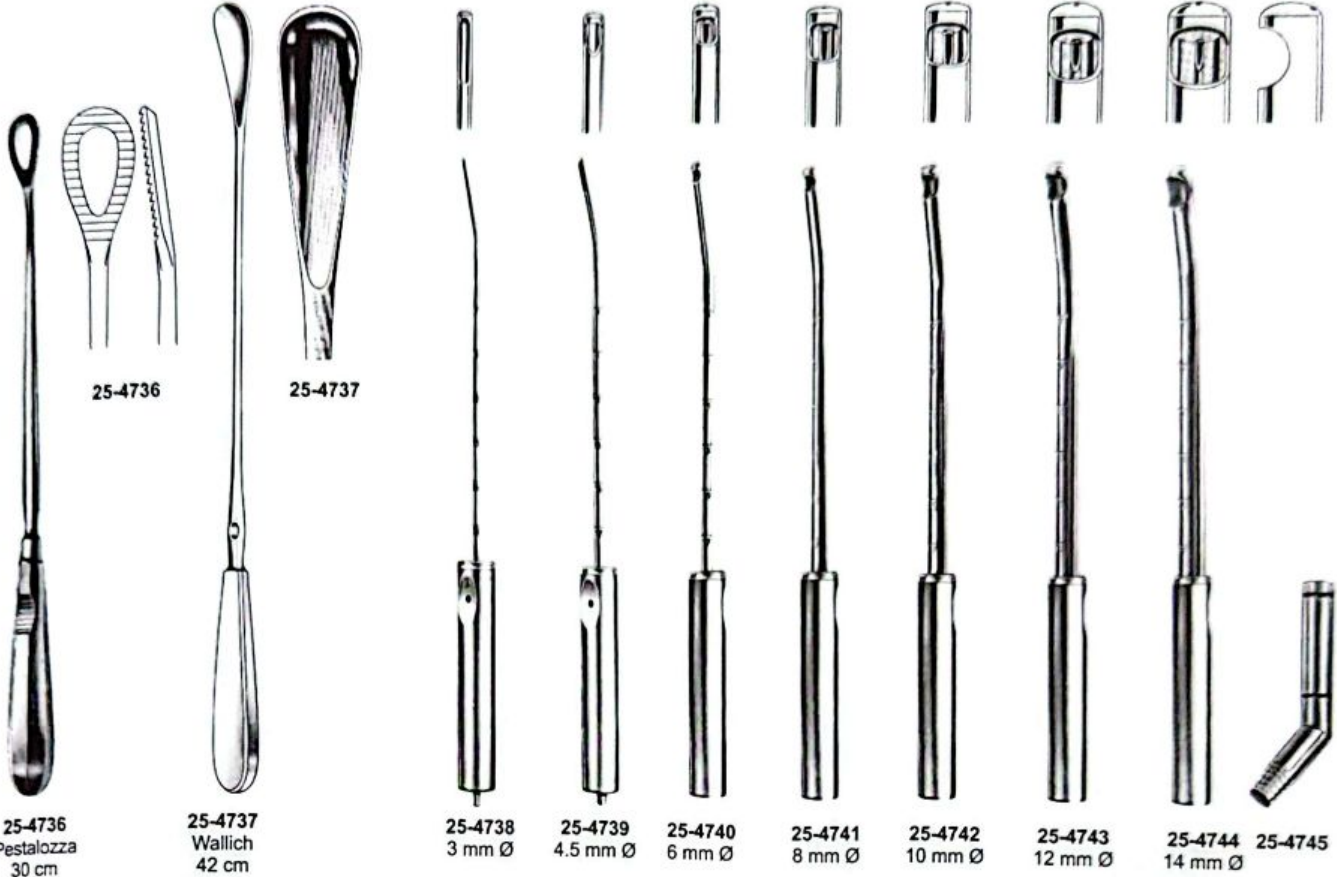

25-4736
Pestalozza
30 cm

25-4736

25-4737
Wallich
42 cm

25-4737

25-4738
3 mm Ø

25-4739
4.5 mm Ø

25-4740
6 mm Ø

25-4741
8 mm Ø

25-4742
10 mm Ø

25-4743
12 mm Ø

25-4744
14 mm Ø

25-4745

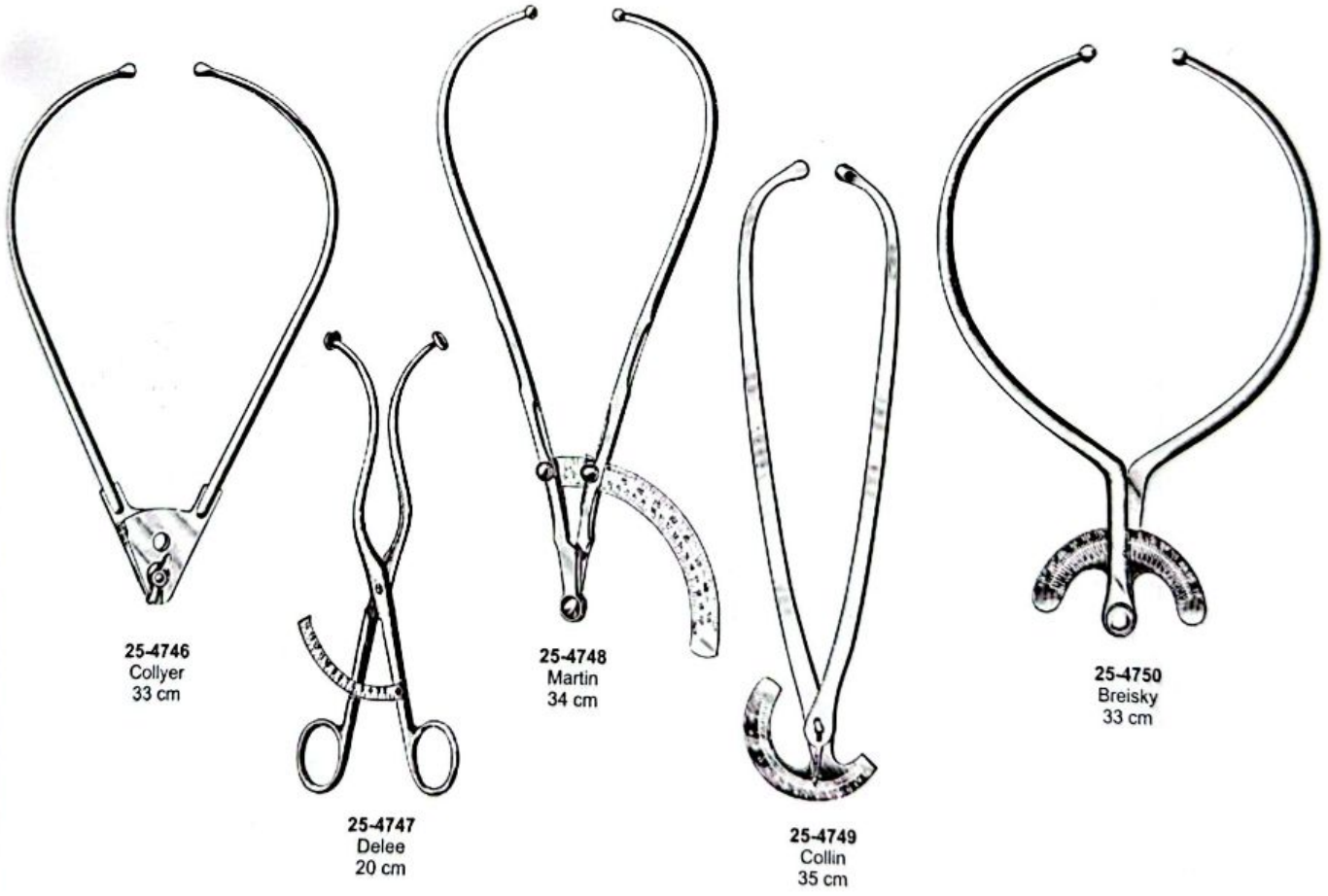

25-4746
Collyer
33 cm

25-4747
Delee
20 cm

25-4748
Martin
34 cm

25-4749
Collin
35 cm

25-4750
Breisky
33 cm



Goitre Enucleator, Goitre Grasping Forceps



26-4800
SCHOEMAKER
15 cm

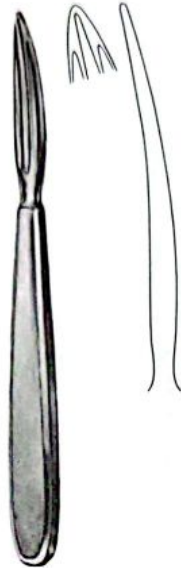

26-4801
Kocher
15 cm

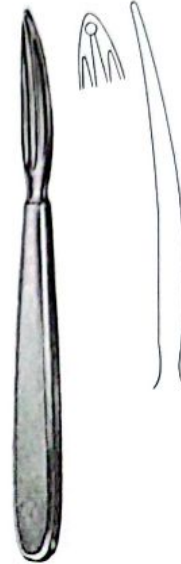

26-4802
Kocher
15 cm

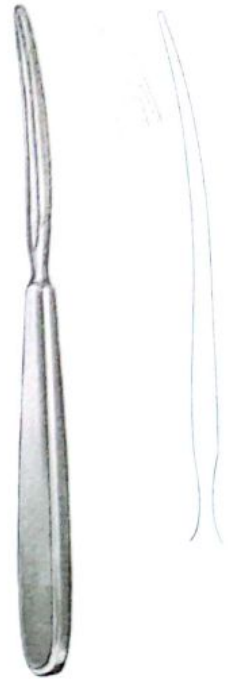

26-4803
Kocher
18 cm

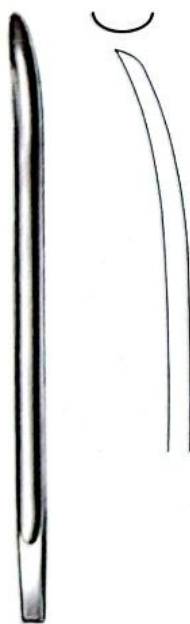

26-4804
Hofmeister
21 cm



26-4805
Lahey
15 cm



26-4806
Mastin
17 cm



Sterilizing Forceps



27-4900
Cheattle
27 cm



27-4901
Cheattle
26.5 cm



27-4902
Cheattle
28 cm



27-4903
20 cm, 30 cm



27-4904
Rogge
23 cm



27-4905
16 cm
27-4906
20 cm
27-4907
24 cm

27-4905-27-4907
Davis



**Nail Scissors, Nail Nippers, Cuticle Scissors,
Nail Files**



28-5000
10.5 cm
11.5 cm



28-5001
10.5 cm
11.5 cm



28-5004
14 cm



28-5005
14 cm
16 cm



28-5006
Turnbull
12 cm, 13 cm



28-5007
13 cm



28-5008
12 cm



28-5009
10 cm, 13 cm
15 cm



28-5010
11 cm, 13 cm



28-5011
10 cm



28-5012
11 cm



28-5013
16 cm



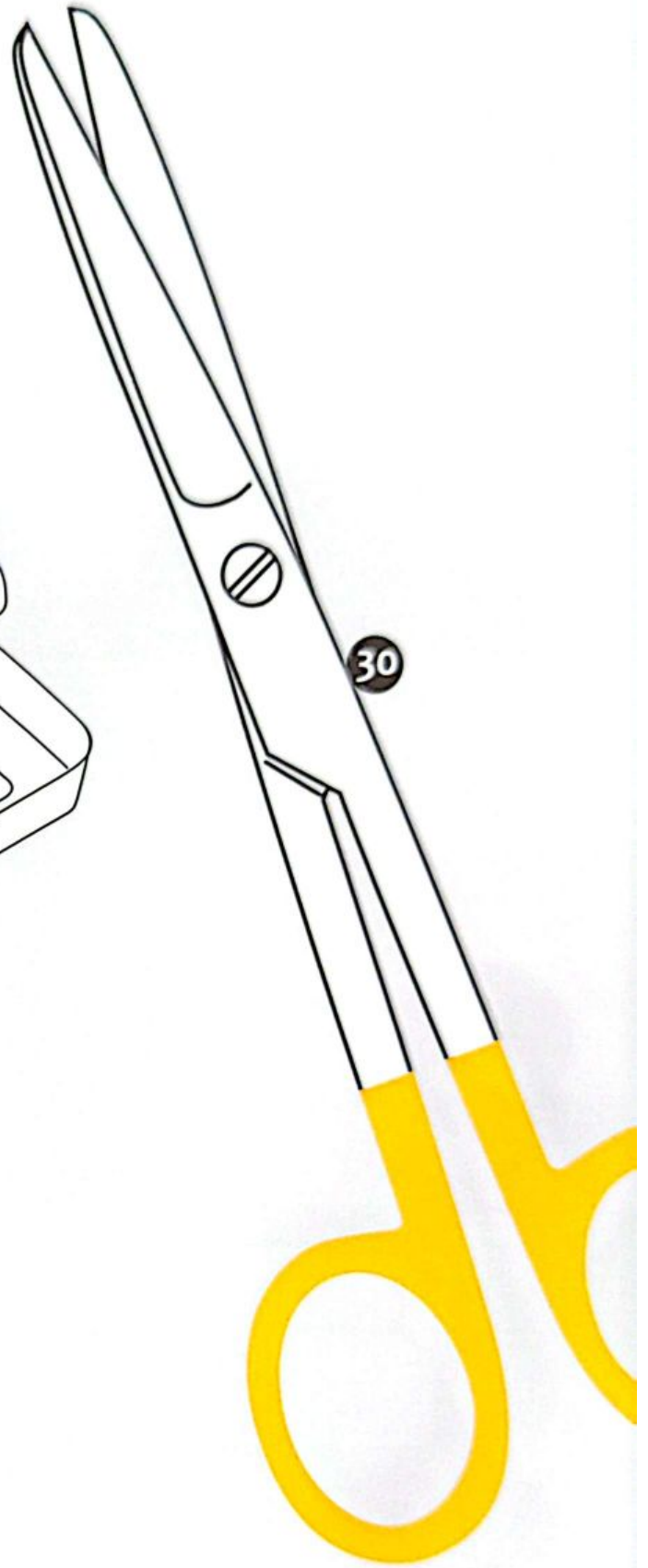
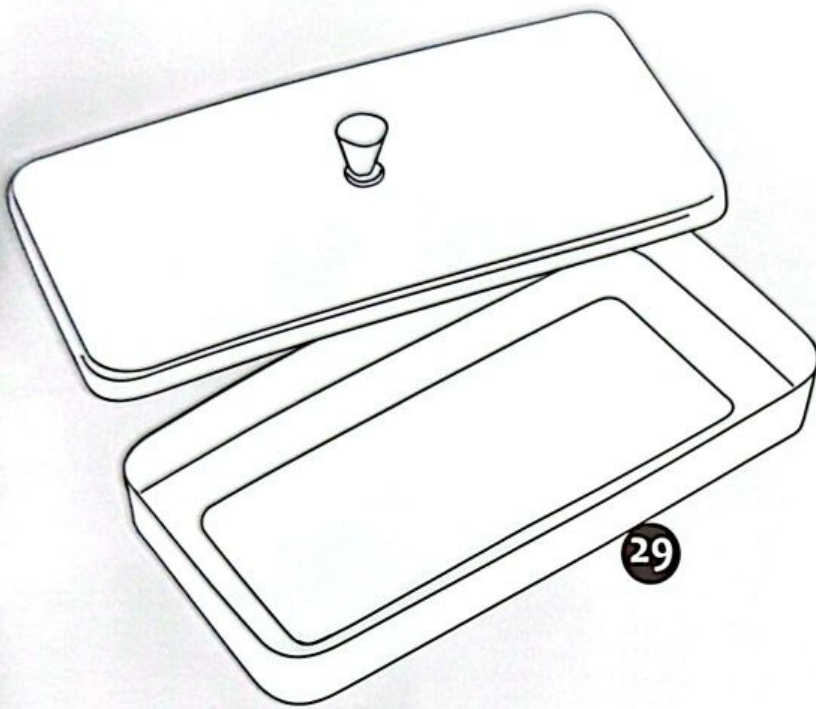

Section # 29-30

- 29 Hollowware
- 30 TC Instruments

Needle Case, Endodontic Box, Tube Rack,
Cotton Holder, Jars, Jallipot, Bowls, Cups



29-5100
Needle Case Round with Cover
65x15mm



29-5101
Needle Case Round
80x20mm



29-5102
Needle Case Rectangle
80x20mm



29-5103
Endodontic Box
100x40x50mm



29-5104-29-5106
Tube Rack

- 29-5104**
6.35x15.25x5cm for 12 tubes
- 29-5105**
6.35x17.75x7.5cm for 27 tubes
- 29-5106**
7.50x17.75x6.35cm for 36 tubes



29-5107
Spirit Lamp
Standard Size



29-5108
Spirit Lamp
Standard Size



- 29-5109**
75x80mm
- 29-5110**
100x50mm
- 29-5111**
100x80mm



- 29-5112**
80x60mm
- 29-5113**
80x80mm
- 29-5114**
100x100mm
- 29-5115**
120x120mm
- 29-5116**
150x150mm
- 29-5117**
180x180mm
- 29-5118**
200x200mm



- 29-5119**
80x60mm
- 29-5120**
80x80mm
- 29-5121**
100x100mm
- 29-5122**
120x120mm
- 29-5123**
150x150mm
- 29-5124**
180x180mm
- 29-5125**
200x200mm

29-5109-29-5111
Sputum Cup

29-5112-29-5118
Dressing Jar

29-5119-29-5125
Dressing Jar



- 29-5126**
100mm Ø
- 29-5127**
120mm Ø
- 29-5128**
150mm Ø
- 29-5129**
200mm Ø



29-5126-29-5129
Funnel

29-5130
Cotton Holder

29-5131
Cotton Holder

29-5132-29-5140
Forceps Jar

- 29-5132**
30x30mm
- 29-5133**
50x125mm
- 29-5134**
50x170mm
- 29-5135**
50x200mm
- 29-5136**
40x230mm
- 29-5137**
70x110mm
- 29-5138**
80x150mm
- 29-5139**
100x200mm
- 29-5140**
150x300mm

Bowls, Cups, Kedney Trays



29-5141-29-5156
Gallipot

- | | |
|---------|---------|
| 29-5141 | 29-5149 |
| 01 oz | 09 oz |
| 29-5142 | 29-5150 |
| 02 oz | 10 oz |
| 29-5143 | 29-5151 |
| 03 oz | 11 oz |
| 29-5144 | 29-5152 |
| 04 oz | 12 oz |
| 29-5145 | 29-5153 |
| 05 oz | 13 oz |
| 29-5146 | 29-5154 |
| 06 oz | 14 oz |
| 29-5147 | 29-5155 |
| 07 oz | 15 oz |
| 29-5148 | 29-5156 |
| 08 oz | 16 oz |



29-5157-29-5159
Sponge Bowl

- | |
|---------|
| 29-5157 |
| 12 cm |
| 29-5158 |
| 15 cm |
| 29-5159 |
| 20 cm |



29-5160-29-5162
Medicine Cup

- | |
|---------|
| 29-5160 |
| 50ml |
| 29-5161 |
| 60ml |
| 29-5162 |
| 70ml |



29-5163-29-5176
Lotion Bowl without spout

- | | |
|----------|-----------|
| 29-5163 | 29-5170 |
| 40x19mm | 150x65mm |
| 29-5164 | 29-5171 |
| 50x25mm | 180x85mm |
| 29-5165 | 29-5172 |
| 60x30mm | 200x100mm |
| 29-5166 | 29-5173 |
| 80x40mm | 250x120mm |
| 29-5167 | 29-5174 |
| 100x50mm | 300mm |
| 29-5168 | 29-5175 |
| 120x60mm | 350mm |
| 29-5169 | 29-5176 |
| 140x60mm | 400mm |



29-5176-29-5180
Wash Basin

- | |
|-----------|
| 29-5176 |
| 300x80mm |
| 29-5177 |
| 320x85mm |
| 29-5178 |
| 330x90mm |
| 29-5179 |
| 350x110mm |
| 29-5180 |
| 400x115mm |



29-5181
Kick Bucket with Trolley
390x280x180mm



29-5182-29-5184
Kidney Tray Shallow

- | |
|---------|
| 29-5182 |
| 17cm |
| 29-5183 |
| 22cm |
| 29-5184 |
| 24 cm |

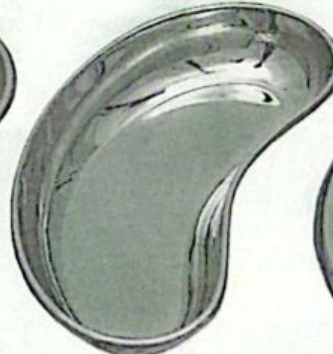

29-5185-29-5191
Kidney Tray

- | | |
|---------|---------|
| 29-5185 | 29-5189 |
| 12 cm | 25 cm |
| 29-5186 | 29-5190 |
| 15 cm | 28 cm |
| 29-5187 | 29-5191 |
| 18 cm | 30 cm |
| 29-5188 | |
| 20 cm | |



29-5192
Kidney Tray (with cover)

- | |
|---------|
| 29-5192 |
| 12 cm |
| 29-5193 |
| 15 cm |
| 29-5194 |
| 18 cm |
| 29-5195 |
| 20 cm |

Wire Mesh Trays, Instruments Trays



29-5196-29-5202
Wire Mesh Tray

- 29-5196 29-5200 480x250x7mm
- 240x250x5mm 29-5201 240x250x10mm
- 480x250x5mm 29-5198 29-5202 480x250x10mm
- 550x250x5mm 29-5199 240x250x7mm



29-5203-29-5209
Wire Mesh Tray with Lid

- 29-5203 29-5207 480x250x7mm
- 240x250x5mm 29-5204 29-5208 240x250x10mm
- 480x250x5mm 29-5205 29-5209 480x250x10mm
- 550x250x5mm 29-5206 240x250x7mm



29-5210-29-5214
Perforated Tray

- 29-5210 29-5213 350x170x50mm
- 200x100x40mm 29-5211 29-5214 400x200x50mm
- 250x120x50mm 29-5212 300x150x50mm



29-5215-29-5222
Instruments Tray without Lid

- 29-5215 29-5219 300x350x50mm
- 100x150x25mm 29-5216 29-5220 150x300x50mm
- 150x200x40mm 29-5217 29-5221 200x300x50mm
- 200x250x45mm 29-5218 29-5222 230x150x50mm
- 250x300x50mm



29-5223-29-5230
Instruments Tray with Lid

- 29-5223 29-5227 300x350x50mm
- 100x150x25mm 29-5224 29-5228 150x300x50mm
- 150x200x40mm 29-5225 29-5229 200x300x50mm
- 200x250x45mm 29-5226 29-5230 230x150x50mm
- 250x300x50mm



29-5231
Burr Tray
190x100x20mm

29-5232-29-5234
Catheter Tray with Lid

- 29-5232 300x80x40mm
- 29-5233 350x90x45mm
- 29-5234 400x100x50mm



29-5235-29-5242
Instruments Box with Hooks

- 29-5235 29-5239 250x125x50mm
- 170x70x30mm 29-5236 29-5240 300x150x50mm
- 180x80x40mm 29-5237 29-5241 350x170x50mm
- 200x100x40mm 29-5238 29-5242 500x200x120mm
- 230x120x50mm



29-5243-29-5250
Instruments Box

- 29-5243 29-5247 250x125x50mm
- 170x70x30mm 29-5244 29-5248 300x150x50mm
- 180x80x40mm 29-5245 29-5249 350x170x50mm
- 200x100x40mm 29-5246 29-5250 500x200x120mm
- 230x120x50mm



29-5251
Scaler Tray with cover
200x100x16mm



Instruments Box, Sterilization Box



29-5252-29-5254
Instruments Box Perforated

29-5252 200x100x40mm	29-5254 300x150x40mm
29-5253 250x150x40mm	



29-5255-29-5260
Electric Sterilizer

29-5255 200x100x120mm	29-5258 350x170x170mm
29-5256 250x120x140mm	29-5259 400x200x180mm
29-5257 300x150x150mm	29-5260 450x230x190mm



29-5261-29-5265
Non Electric Sterilizer

29-5261 200x100x65mm	29-5264 350x170x65mm
29-5262 250x125x65mm	29-5265 400x200x100mm
29-5263 300x150x100mm	

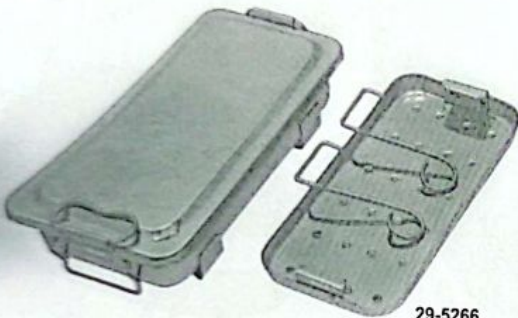

29-5266-29-5269
Electric Sterilizer

280x125x65mm

29-5266
170x70x30mm

29-5267
180x80x40mm

29-5268
200x100x40mm

29-5269
230x120x50mm



29-5270-29-5287
Sterilizer Drum

29-5270 125x80mm	29-5279 240x240mm
29-5271 125x120mm	29-5280 290x140mm
29-5272 150x100mm	29-5281 290x240mm
29-5273 150x150mm	29-5282 290x290mm
29-5274 180x180mm	29-5283 340x160mm
29-5275 190x140mm	29-5284 340x340mm
29-5276 190x190mm	29-5285 390x150mm
29-5277 200x200mm	29-5286 390x200mm
29-5278 240x120mm	29-5287 390x290mm



29-5288
Bedpan Hand Made
Standard



29-5289-29-5290
Bedpan Hand Made

29-5289 Adult	29-5290 Child
-------------------------	-------------------------



29-5291
Bedpan Hand Made
Standard

Urinal, Bedpan, Bucket, Jug



29-5292-29-5293
Bedpan Sleeper Type

29-5292 Adult
29-5293 Child



29-5294
Bedpan Chamber Port
Standard



29-5295-29-5296
Bedpan Simple
pressed body with handle

29-5295 Adult
29-5296 Child



29-5297
Urinal Female
Standard



29-5298
Urinal Male Vertical
Standard



29-5299
Urinal Male
Standard



29-5300
Bedpan perfection type seamless
350x300mm



29-5301
Bedpan perfection type
370x290mm

29-5302
320x240mm



29-5303-29-5305
Measuring Jug

29-5303 0.5 Ltr
29-5304 1.5 Ltr
29-5304 2.0 Ltr



29-5306-29-5308
Pail/Bucket with Lid

29-5306 0.6 Ltr
29-5307 1.5 Ltr
29-5307 10 Ltr



29-5309-29-5311
Douch Can/ringator

29-5309 1.0 Ltr
29-5310 2.0 Ltr
29-5311 1.5 Ltr



Nasal Scissors, Aquila-Scissors



Dissecting Scissors

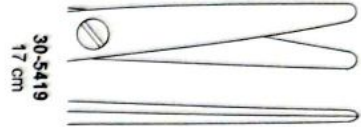

30-5418
Mayo-Sille
17 cm

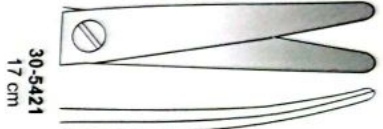

30-5420
Mayo-Sille
17 cm

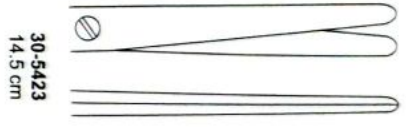

30-5422
Mayo-Sille
14.5 cm

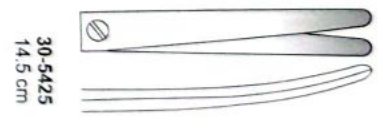

30-5425
Mayo-Sille
14.5 cm

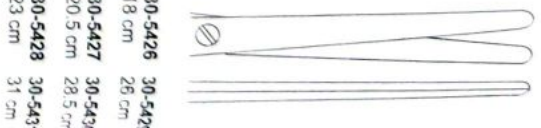

30-5426
Mayo-Sille
26 cm



30-5419
Mayo-Sille
17 cm



30-5421
Mayo-Sille
17 cm



30-5423
Mayo-Sille
14.5 cm



30-5424
Mayo-Sille
11.5 cm



30-5427
Mayo-Sille
20.5 cm

30-5418
Mayo-Sille
14.5 cm

30-5420
Mayo-Sille
14.5 cm

30-5422
Metzenbaum
11.5 cm

30-5424
Metzenbaum
11.5 cm

30-5426-30-5431
Metzenbaum

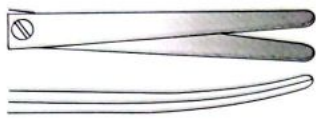

30-5432
18 cm



30-5438
20 cm



30-5441
14.5 cm



30-5444
21 cm



30-5433
20.5 cm

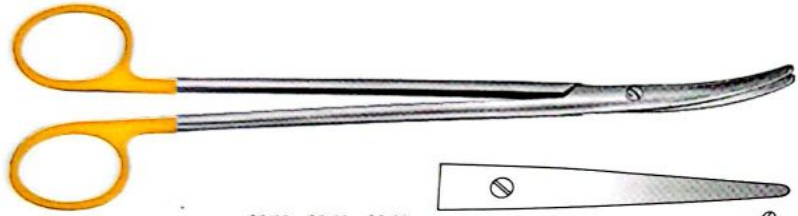

30-5439
23 cm

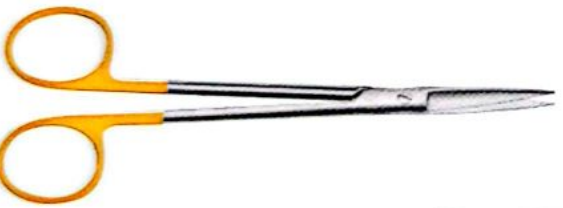

30-5442
14.5 cm



30-5443
Lexer
16 cm

30-5432-30-5437
Metzenbaum

30-5438-30-5440
Metzenbaum-Thorek

30-5441-30-5442
Joseph



Dissecting Scissors, Operating Scissors,
Delicate Dissecting Scissors

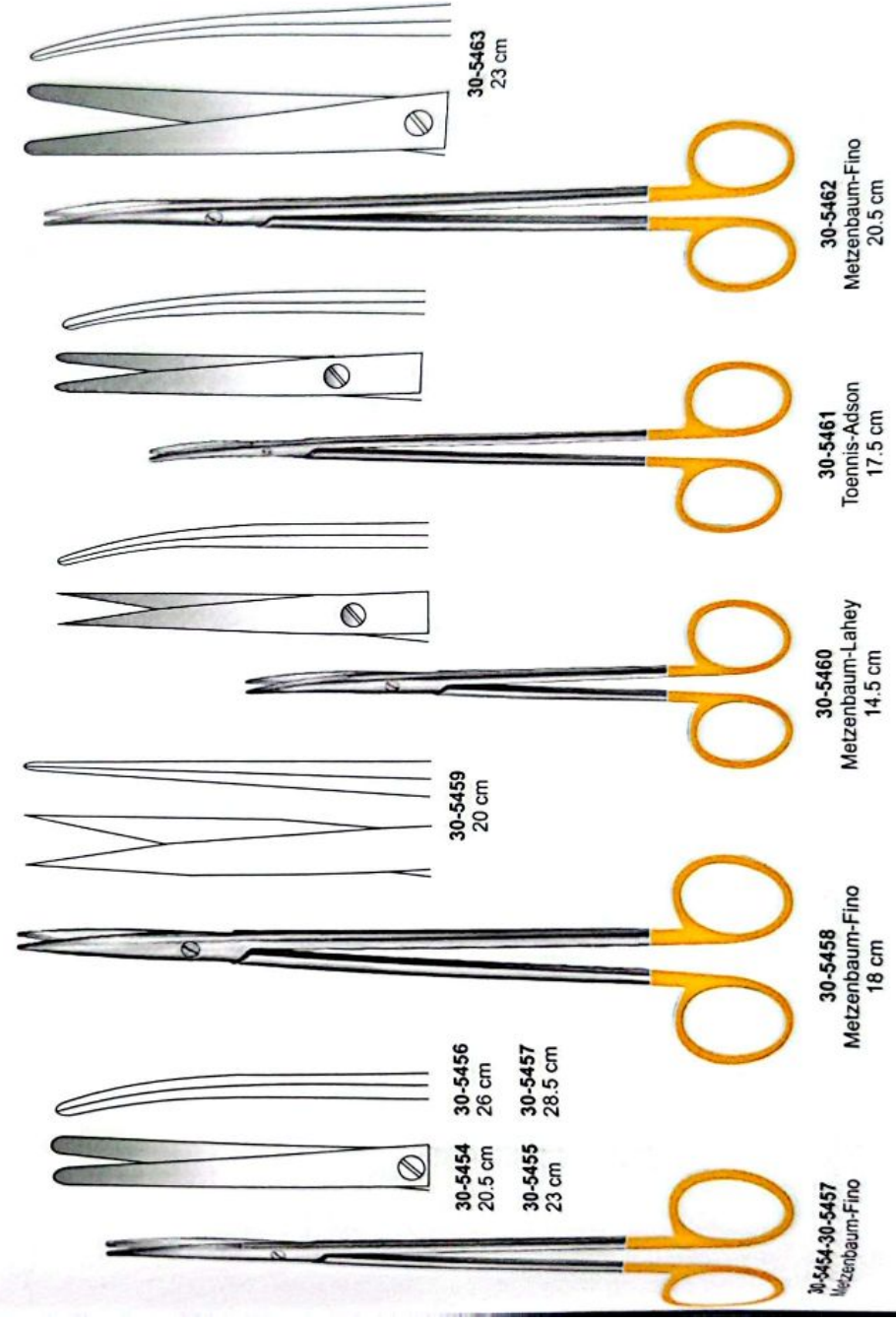
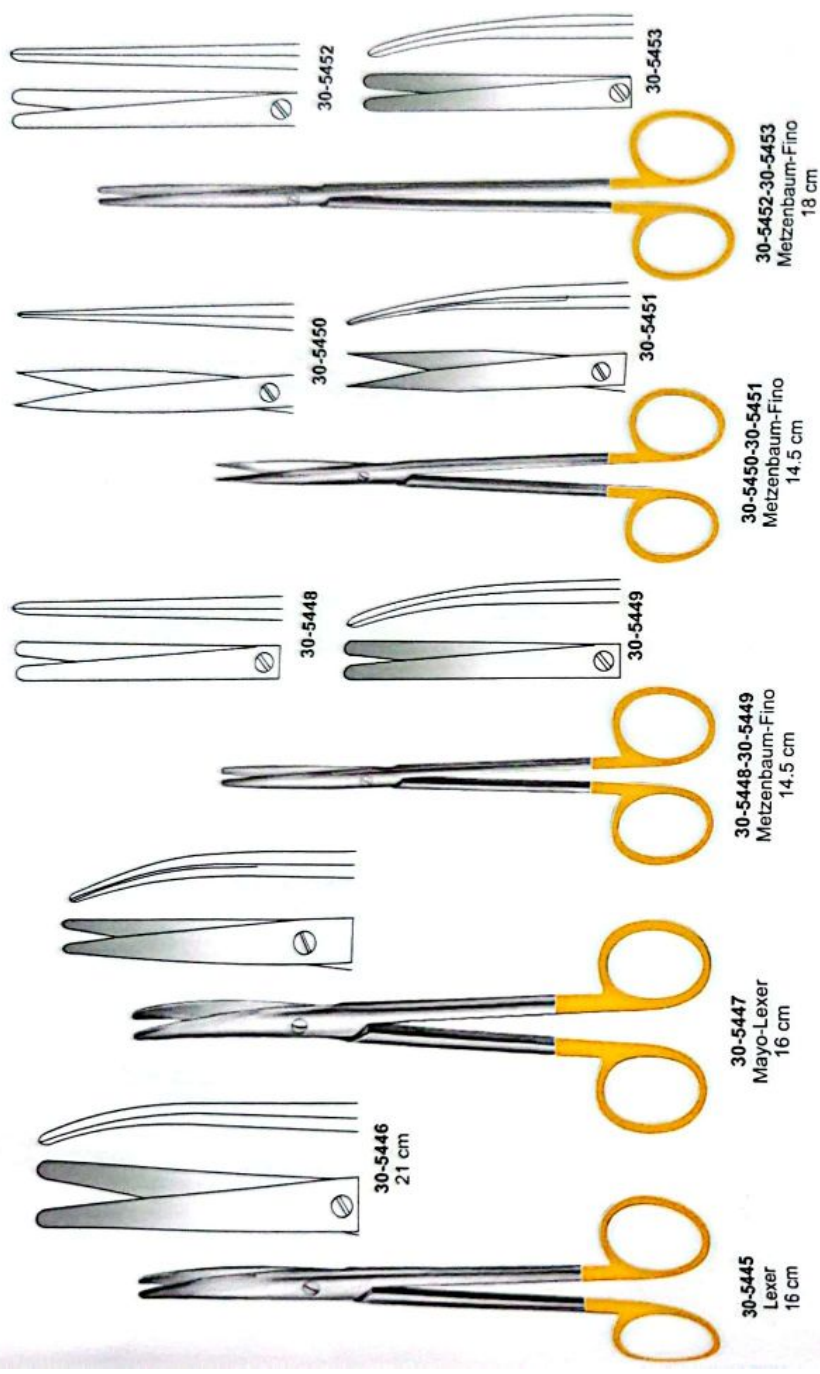

**Delicate Dissecting Scissors, Face-lift Scissors,
Aquila Scissors, Uterine Scissors**



30-5464-30-5466
Meizenbaum-Fino

30-5467
Gorney
20 cm

30-5469
Rees
17 cm

30-5470
Sims-Aquila
20 cm

30-5472
22 cm

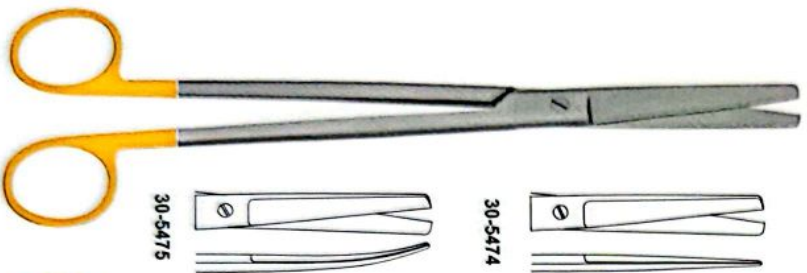

30-5474-30-5475
Sims
23 cm

30-5476
Goldmann-Fox
13 cm

30-5478
11.5 cm

30-5480
11.5 cm

30-5481
11 cm



Ligature Scissors, Iris Scissors, Angled Scissors

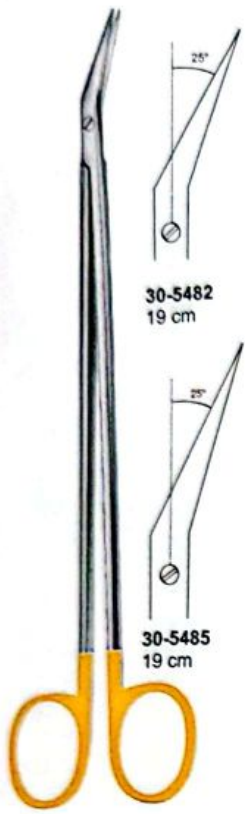

30-5482
19 cm

30-5485
19 cm

30-5482-30-5487
De Bakey

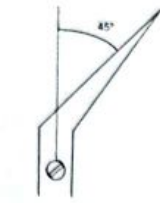

30-5483
18.5 cm

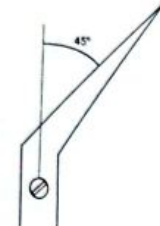

30-5486
23 cm

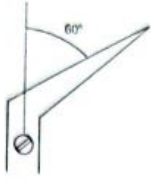

30-5484
18 cm

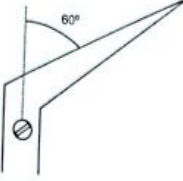

30-5487
22 cm

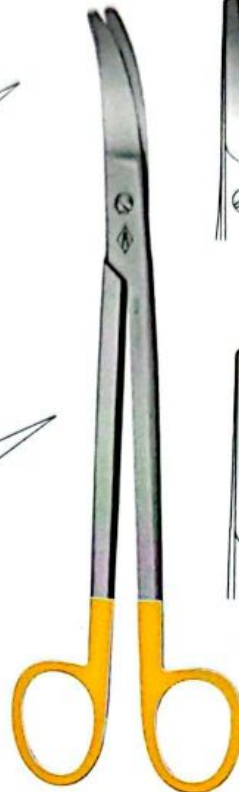

30-5488
22 cm

30-5489
23 cm

30-5488-30-5489



30-5490
Ragnell
12.5 cm

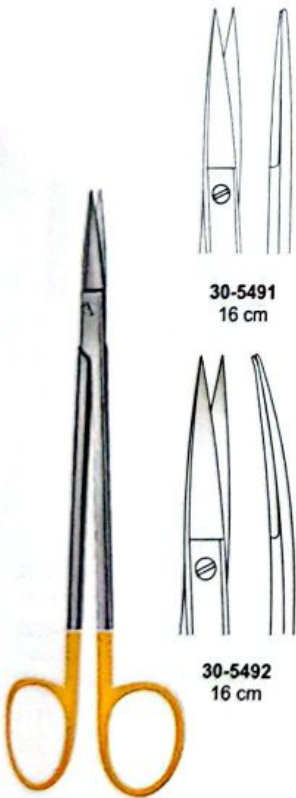

30-5491
16 cm

30-5492
16 cm

30-5491-30-5492
Kelly



30-5493
Dean
17.5 cm



30-5494
Locklin
16 cm

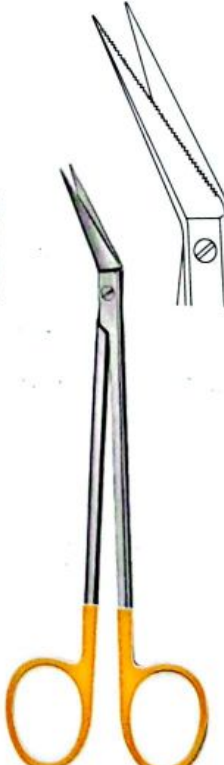

30-5495
Locklin
16 cm

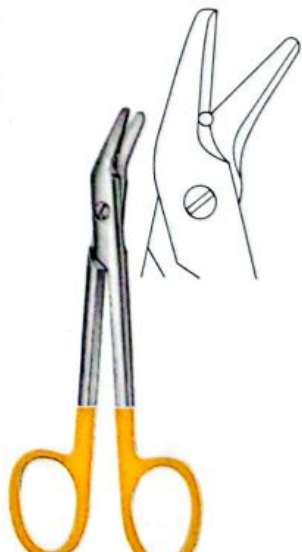

30-5496
Universal
12.5 cm



Tissue Forceps, Dissecting Forceps

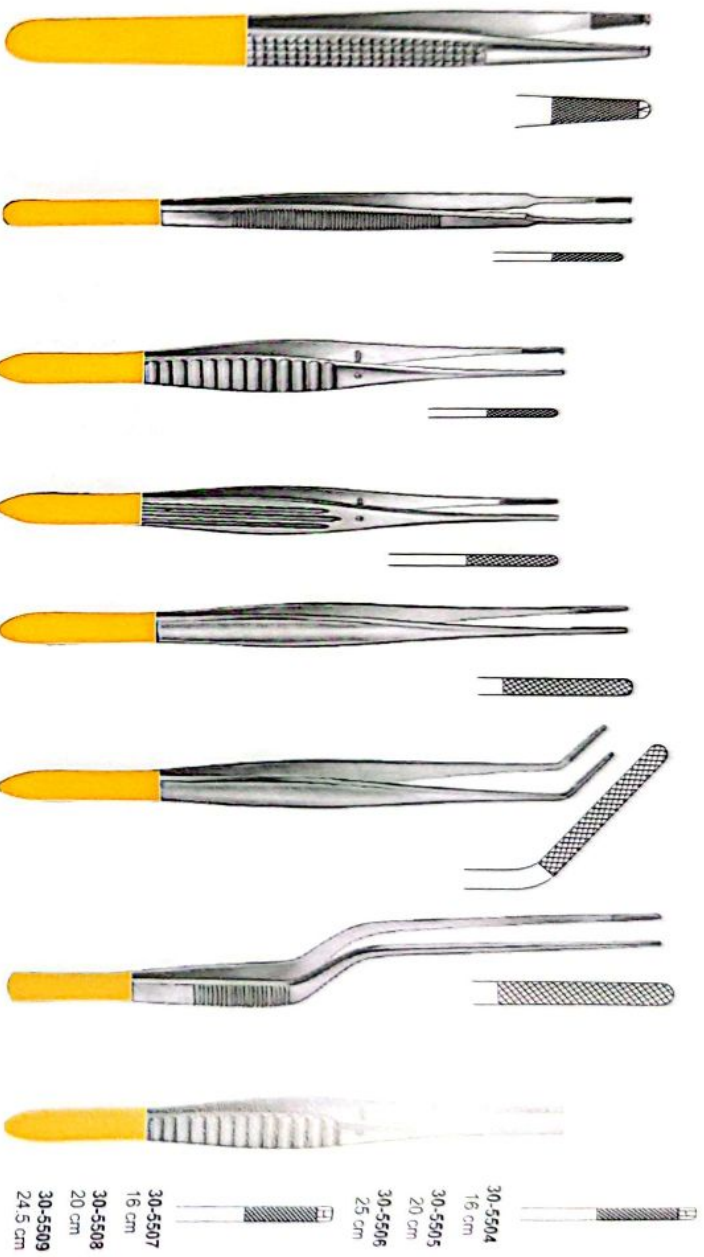

30-5497
Bonney
17.5 cm

30-5498
Gerard
17.5 cm

30-5499
Gillies
15.5 cm

30-5500
McIndoe
15 cm

30-5501
Cushing

30-5502
Bonney
17.5 cm

30-5503
Cushing-Taylor
18.5 cm

30-5504-30-5509
De Bakery

30-5504
16 cm
30-5505
20 cm
30-5506
25 cm
30-5507
16 cm
30-5508
20 cm
30-5509
24.5 cm

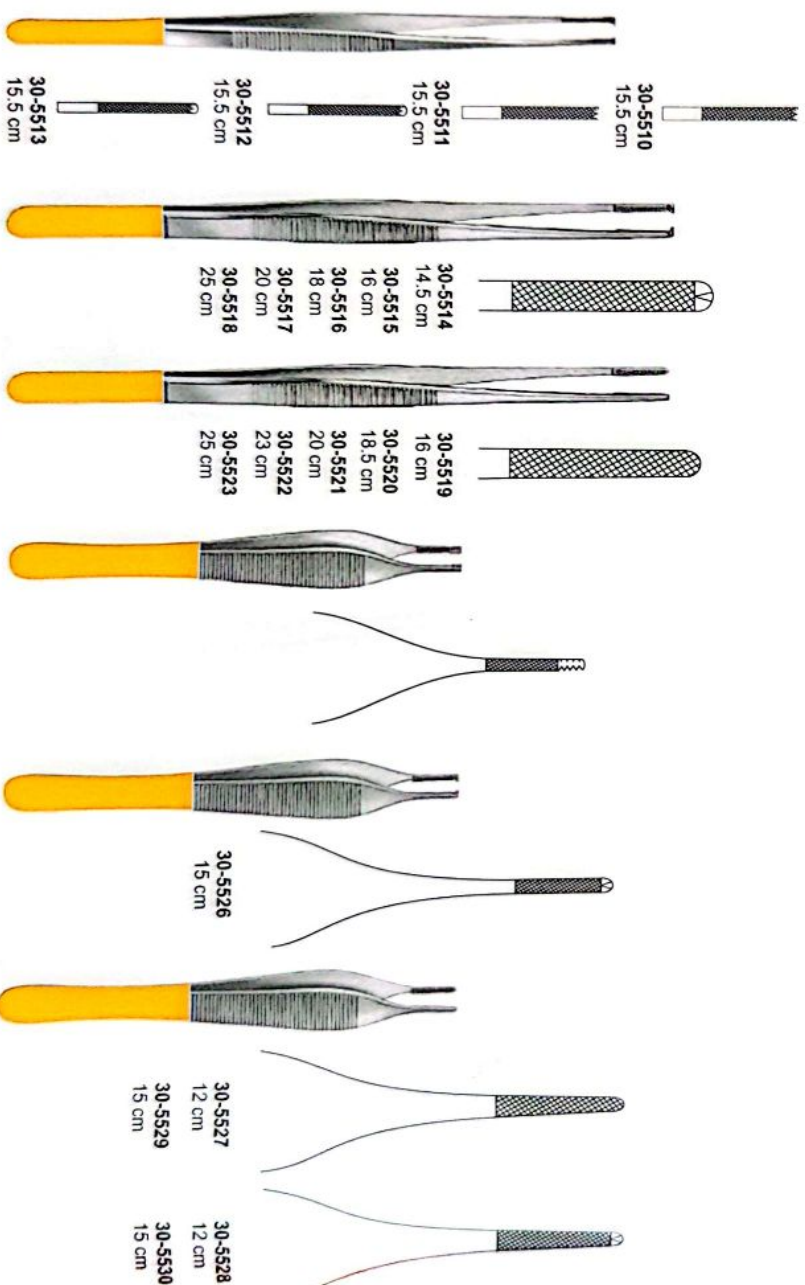

30-5510
15.5 cm

30-5511
15.5 cm

30-5512
15.5 cm

30-5513
15.5 cm

30-5514
14.5 cm

30-5515
16 cm
30-5516
18 cm
30-5517
20 cm
30-5518
25 cm

30-5519
16 cm

30-5520
18.5 cm
30-5521
20 cm
30-5522
23 cm
30-5523
25 cm



30-5524
Adson-Brown
12 cm



30-5525
Adson
12 cm



30-5526
15 cm



30-5527-30-5530
Adson

30-5527
12 cm
30-5529
15 cm
30-5528
12 cm
30-5530
15 cm

30-5510-30-5513
Semken

30-5514-30-5518
Oehler

30-5519-30-5523
Polis-Smith

Micro Needle Holders

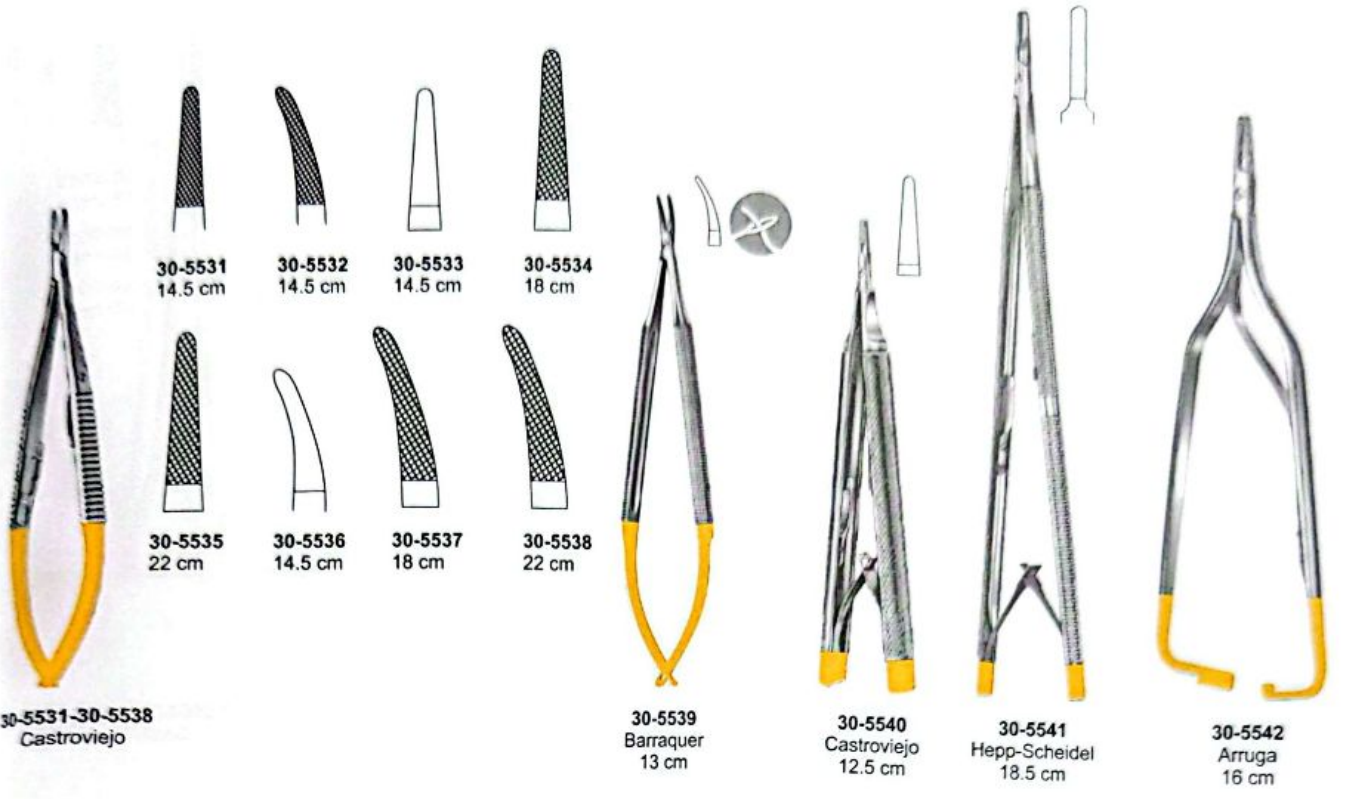

30-5531-30-5538
Castroviejo



Micro Needle Holders, Needle Holders



30-5548
13 cm
30-5549
13 cm

30-5548-30-5549
Halsey

30-5550
Crile-Wood
15 cm

30-5551
Crile-Wood
20 cm

30-5552-30-5554
Sarot

30-5555
20.5 cm
30-5556
24 cm
30-5557
26.5 cm

30-5558
16 cm
30-5561
24 cm

30-5559
20 cm
30-5562
26 cm

30-5560
20 cm
30-5563
30 cm

30-5564
18 cm
30-5565
20 cm
30-5566
23 cm
30-5567
26 cm
30-5568
31 cm

30-5555-30-5557
Heaney

30-5558-30-5563
Mayo-Hegar

30-5564-30-5568
De Bakey



Needle Holders



30-5569
15 cm
30-5570
17 cm
30-5571
20.5 cm

30-5569-30-5571
Martin

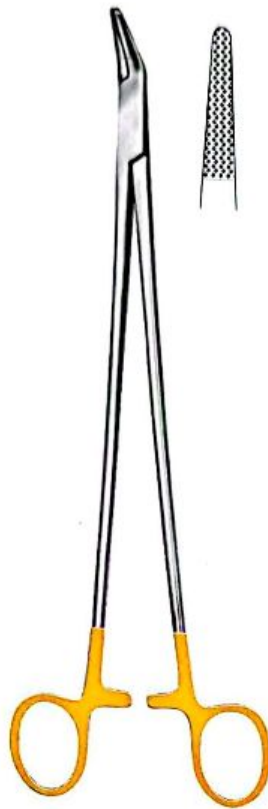

30-5572
27 cm

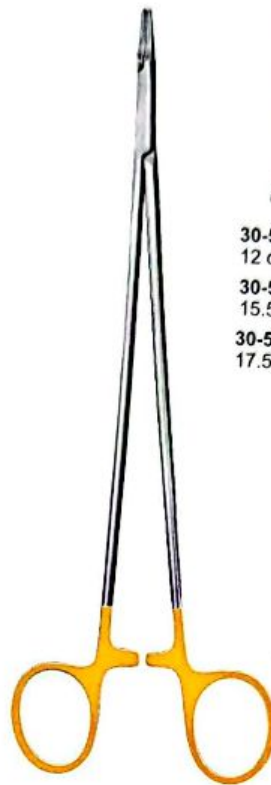

30-5573 30-5576
12 cm 20 cm
30-5574 30-5577
15.5 cm 22.5 cm
30-5575 30-5578
17.5 cm 26 cm

30-5573-30-5578
Ryder-Vascular



30-5579
27 cm



30-5580 30-5582
14 cm 20.5 cm
30-5581 30-5583
18.5 cm 23 cm

30-5580-30-5583
Hegar-Vascular

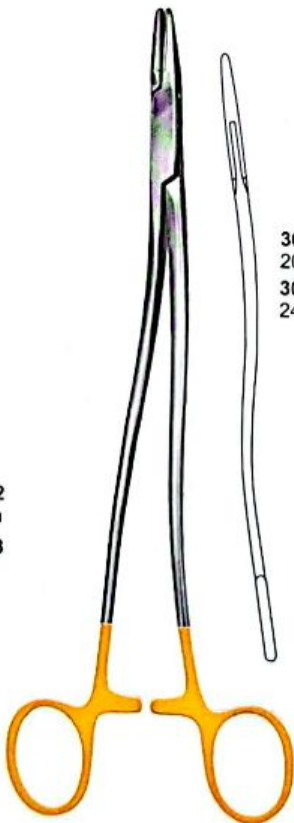

30-5584-30-5587

30-5584 30-5586
20.5 cm 26 cm
30-5585 30-5587
24 cm 29 cm



30-5588
Hegar
20 cm



30-5590
Masson
26.5 cm



Needle Holders



- 30-5591 30-5594
13 cm 20 cm
- 30-5592 30-5595
15 cm 23 cm
- 30-5593 30-5596
18 cm 26 cm

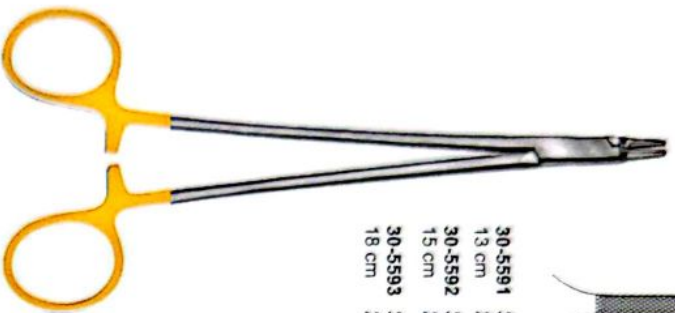

30-5591-30-5596
Ryder



30-5597-30-5598
Stratte
23 cm

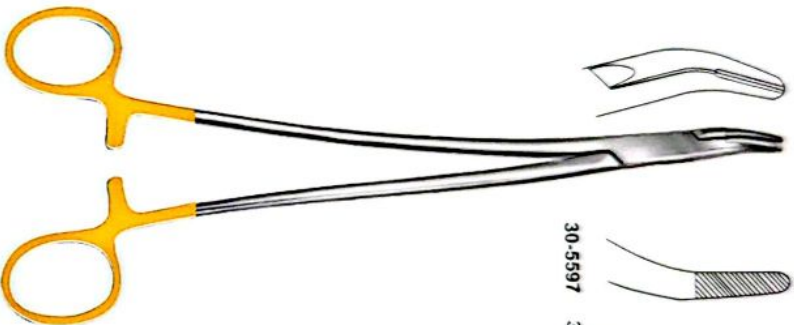

- 30-5599 30-5600
14 cm 20 cm
- 30-5601 30-5602
17.5 cm 23 cm



30-5599-30-5602
Microvascular



- 30-5603 30-5605
14 cm 17.5 cm
- 30-5604 30-5606
16 cm 20 cm

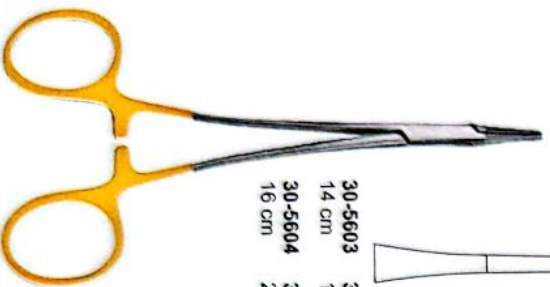

30-5603-30-5606
Martini



- 30-5607 30-5609
14 cm 17.5 cm
- 30-5608 30-5610
15 cm 20 cm

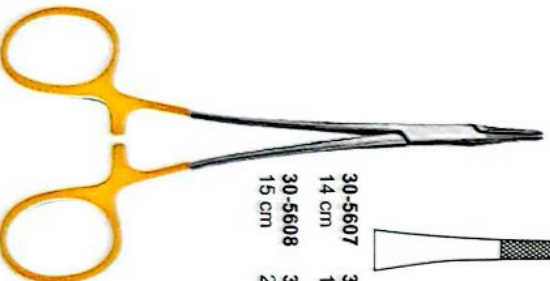

30-5607-30-5610
Martini



- 30-5611 30-5612
14.5 cm 17 cm
- 30-5613

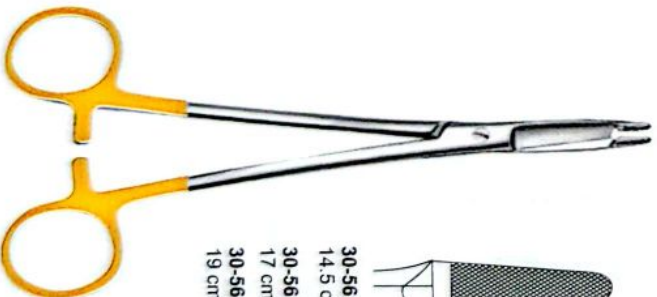

30-5611-30-5613
Olsen Hegar



30-5614
Gillies
16 cm



Needle Holders

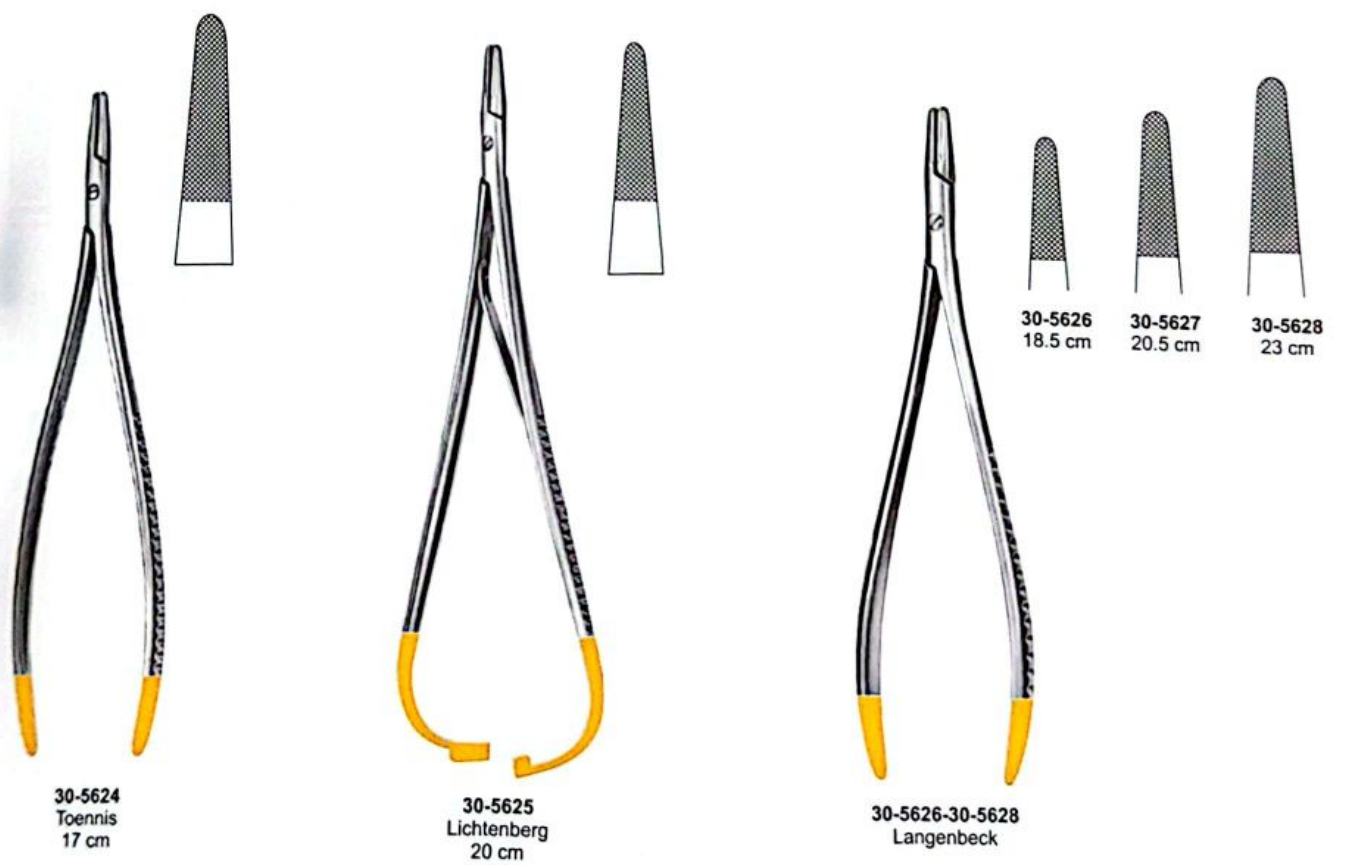
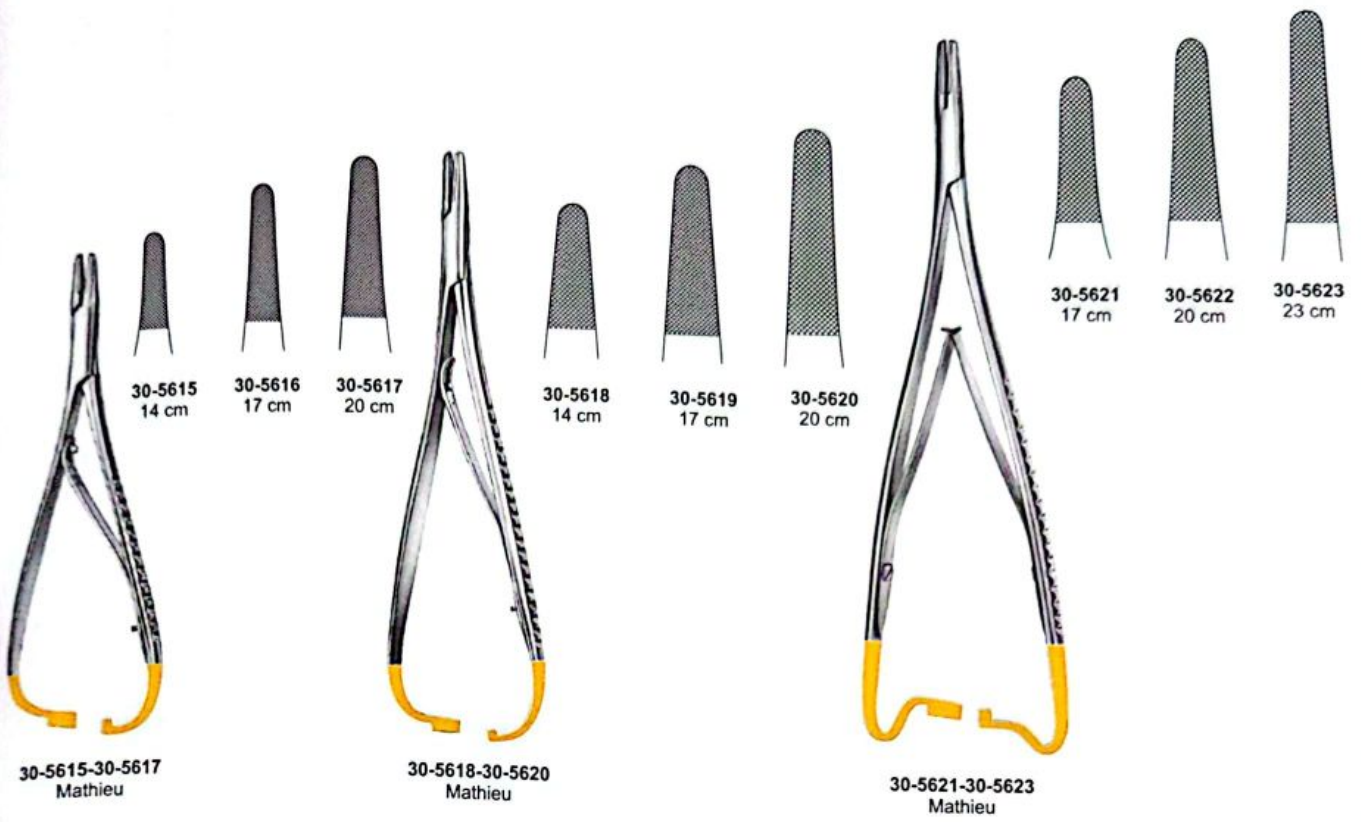

Flat Nose Wire Holding Forceps and Pliers



30-5629
15 cm
30-5630
15 cm

30-5631
15 cm
30-5632
15 cm

30-5629-30-5630
15 cm

30-5631-30-5632
15 cm

30-5633
15 cm

30-5634
20 cm



30-5635
17 cm

30-5636
18.5 cm

30-5637
18.5 cm

30-5638
18.5 cm

30-5639
18.5 cm

30-5637-30-5639
18 cm



Wire Cutting Pliers



For Hard Wire
up to 1.0 mm Ø
For Soft Wire
up to 1.6 mm Ø

30-5640
18.5 cm



For Hard Wire
up to 1.6 mm Ø
For Soft Wire
up to 2.0 mm Ø

30-5641
REILL
16 cm



For Hard Wire
up to 2.0 mm Ø
For Soft Wire
up to 2.0 mm Ø

30-5642
22 cm

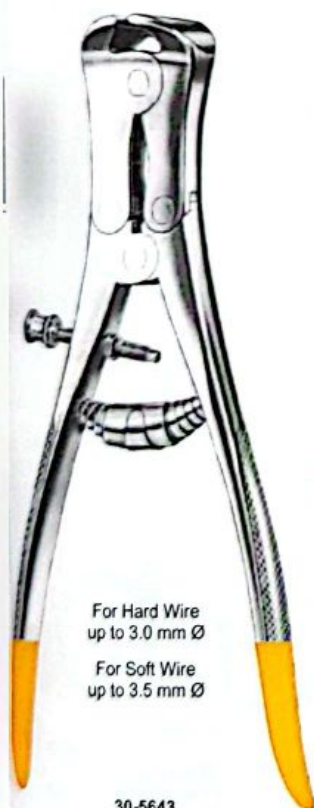

For Hard Wire
up to 3.0 mm Ø
For Soft Wire
up to 3.5 mm Ø

30-5643
23 cm



30-5644
25 cm

For Hard Wire
up to 3.0 mm Ø
For Soft Wire
up to 3.5 mm Ø

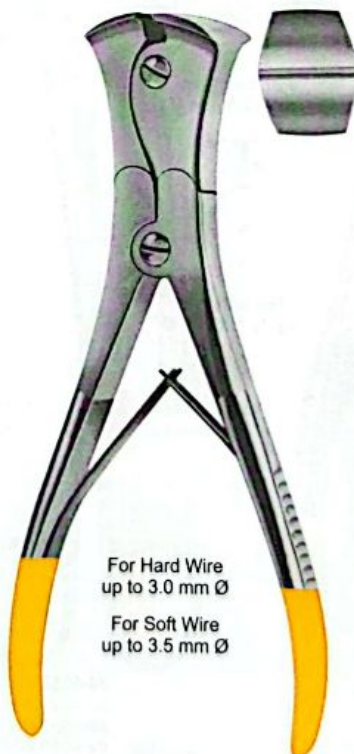

For Hard Wire
up to 3.0 mm Ø
For Soft Wire
up to 3.5 mm Ø

30-5645
22 cm



For Hard Wire
up to 2.5 mm Ø
For Soft Wire
up to 3.0 mm Ø

30-5646
23.5 cm



Wire Cutting Pliers

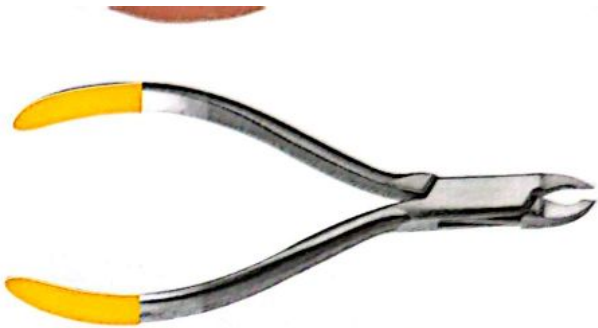

30-5647
Angle
12 cm

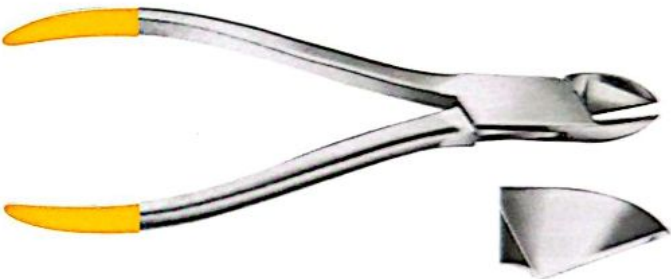

30-5648
14 cm



30-5649
32 cm

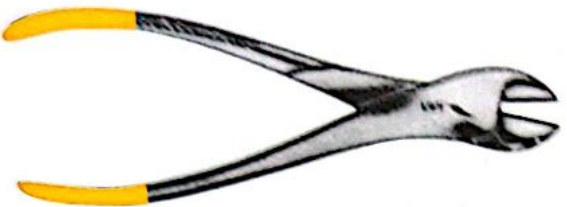

30-5650
14 cm
30-5651
18 cm

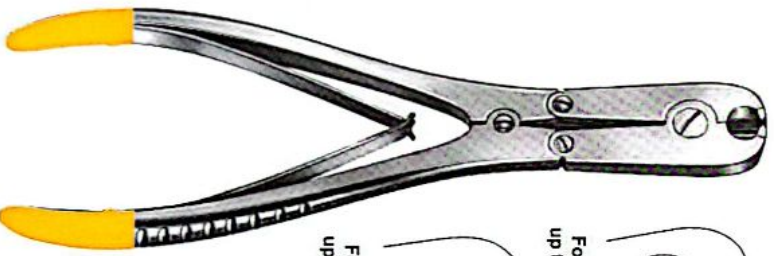

30-5652
18 cm

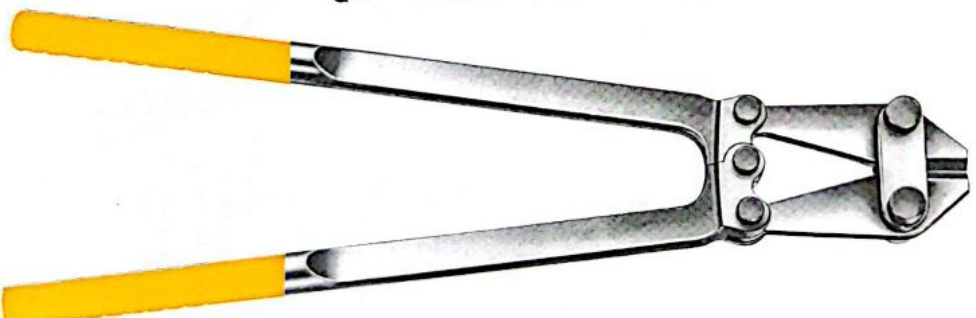
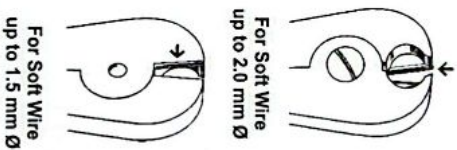

30-5653 - 30cm
for wire up to 4.0 mm Ø
30-5654 - 47cm
for wire up to 5.0 mm Ø
30-5655 - 56cm
for wire up to 6.0 mm Ø



30-5656 - 30cm
for wire up to 4.0 mm Ø
30-5657 - 47cm
for wire up to 5.0 mm Ø
30-5658 - 56cm
for wire up to 6.0 mm Ø



Wire Cutting Pliers



Standard
30-5661
13 cm-Curved
30-5662
14.5 cm-Curved

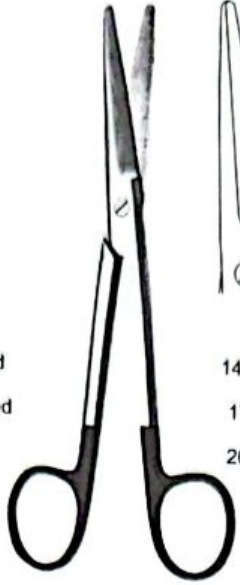

Mayo
30-5666
14.5 cm-Curved
30-5667
17 cm-Curved
30-5668
20 cm-Curved

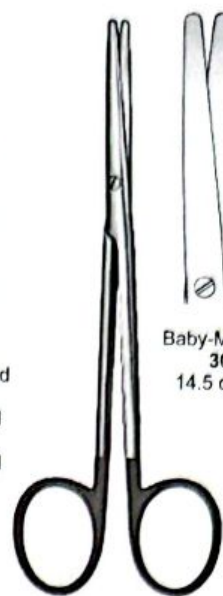

Baby-Metzenbaum
30-5670
14.5 cm-Curved

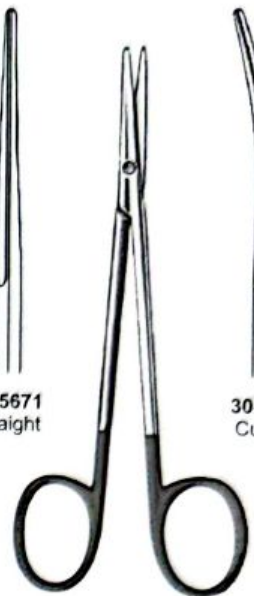

30-5671
Straight

30-5672
Curved

Standard
30-5659
13 cm-Straight
30-5660
14.5 cm-Straight

Mayo
30-5663
14.5 cm-Straight
30-5664
17 cm-Straight
30-5665
20 cm-Straight

Baby-Metzenbaum
30-5669
14.5 cm-Straight

Strabismus
30-5671-30-5672
11.5 cm

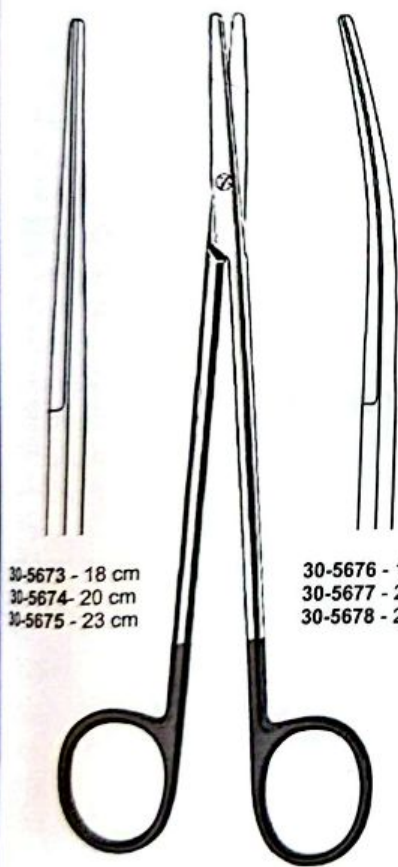

30-5673 - 18 cm
30-5674 - 20 cm
30-5675 - 23 cm

30-5676 - 18 cm
30-5677 - 20 cm
30-5678 - 23 cm

Metzenbaum-Nelson
30-5673 - 30-5678

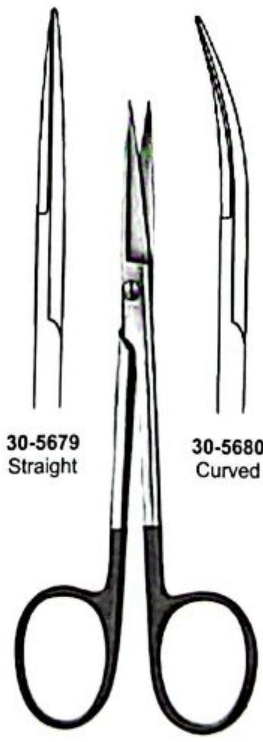

30-5679
Straight

30-5680
Curved

Iris
30-5679-30-5680
11.5 cm

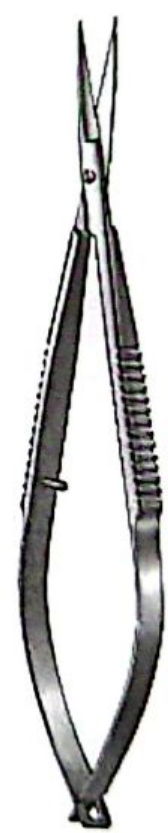

Westcott
30-5681-30-5682
11.5 cm

30-5681
Straight

30-5682
Curved

