



Préparation Scissors
 Scissor dissection
 Forbice per dissezione
 Tijeras para disección
 Ciseaux de dissection

Cockpitteile und außen
 Cutting internal and external
 Taglio interno ed esterno
 Acabados interiores y exteriores
 Garnitures intérieures et extérieures

Gezahnt
 Serrated
 Dentellate
 Dentadas
 Denteles

Kurzen Ende
 Short end
 Punta corta
 Punta corta
 Pointe courte

Fein
 Delicate
 Fine
 Finas
 Fins

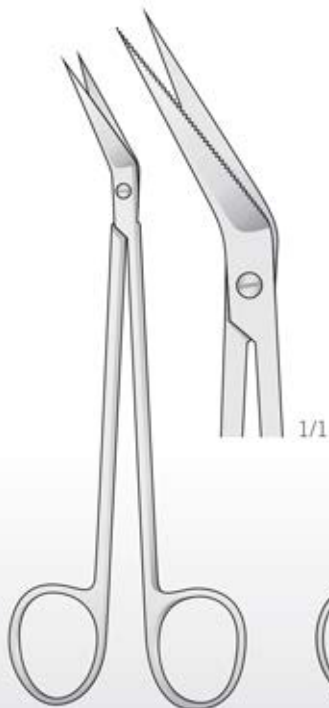

1/1

1/1



1/1

1/1

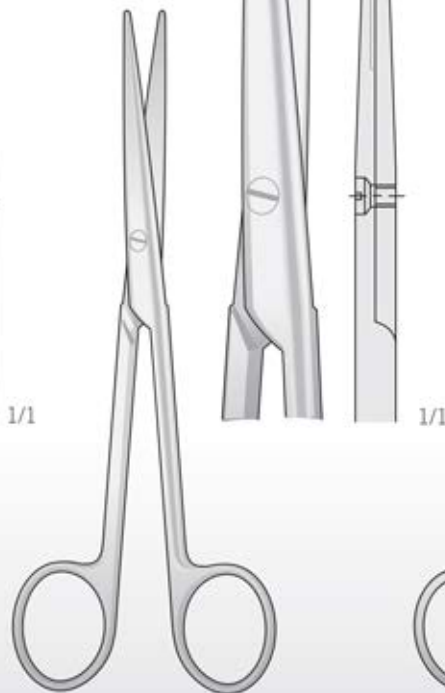

1/1

1/1

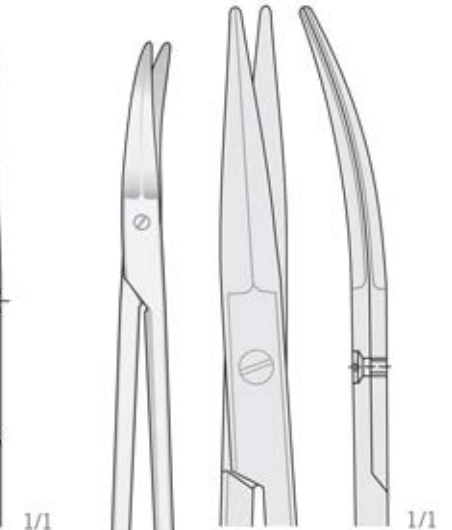

1/1

1/1

LOCKLIN
LK-4
 160 mm

METZENBAUM
FM-12
 150 mm

LEXER
FM-180
 165 mm

FG-10
 185 mm



General Surgery
Allgemeine Chirurgie
Chirurgie générale
Cirugia General
Chirurgia Generale

Fein - Delicate
Fine - Finas
Fins

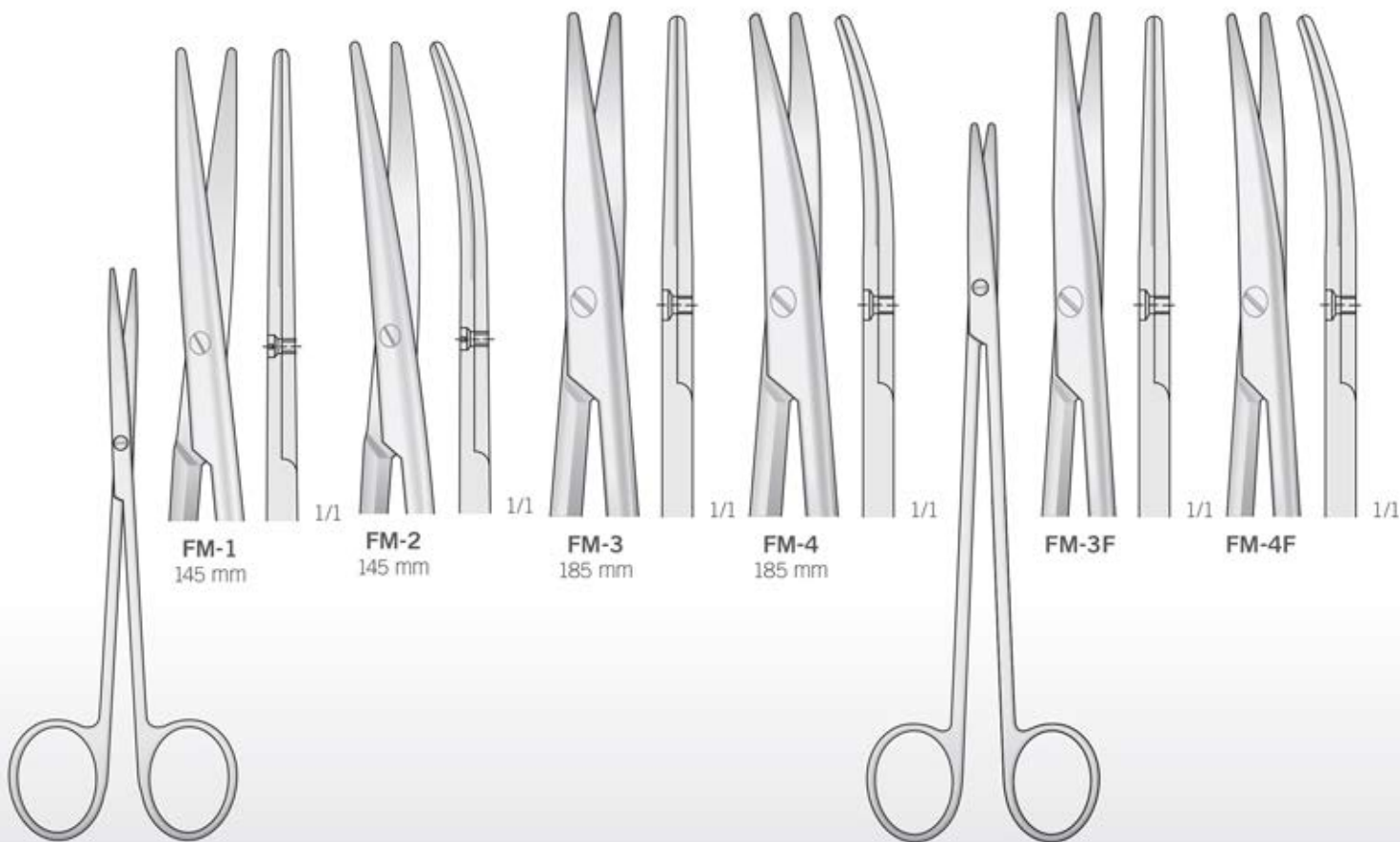

FM-1
145 mm

FM-2
145 mm

FM-3
185 mm

FM-4
185 mm

FM-3F

FM-4F

METZENBAUM
FM-1/FM-2
145 mm

METZENBAUM
FM-3F/FM-4F
185 mm



Scheren für Verbände
 Scissors for bandages
 Forbici per bende
 Tijeras para vendajes
 Ciseaux pour bandages

Schere zu entfernen Nähte
 Scissors to remove sutures
 Forbici per rimuovere suture
 Tijeras para quitar las suturas
 Des ciseaux pour enlever les sutures

Pinzette zum Entfernen von Drähten
 Tweezers for removing wires
 Pinza per rimozione punti metallici
 Pinzas para quitar cables
 Pince à épiler pour enlever les fils

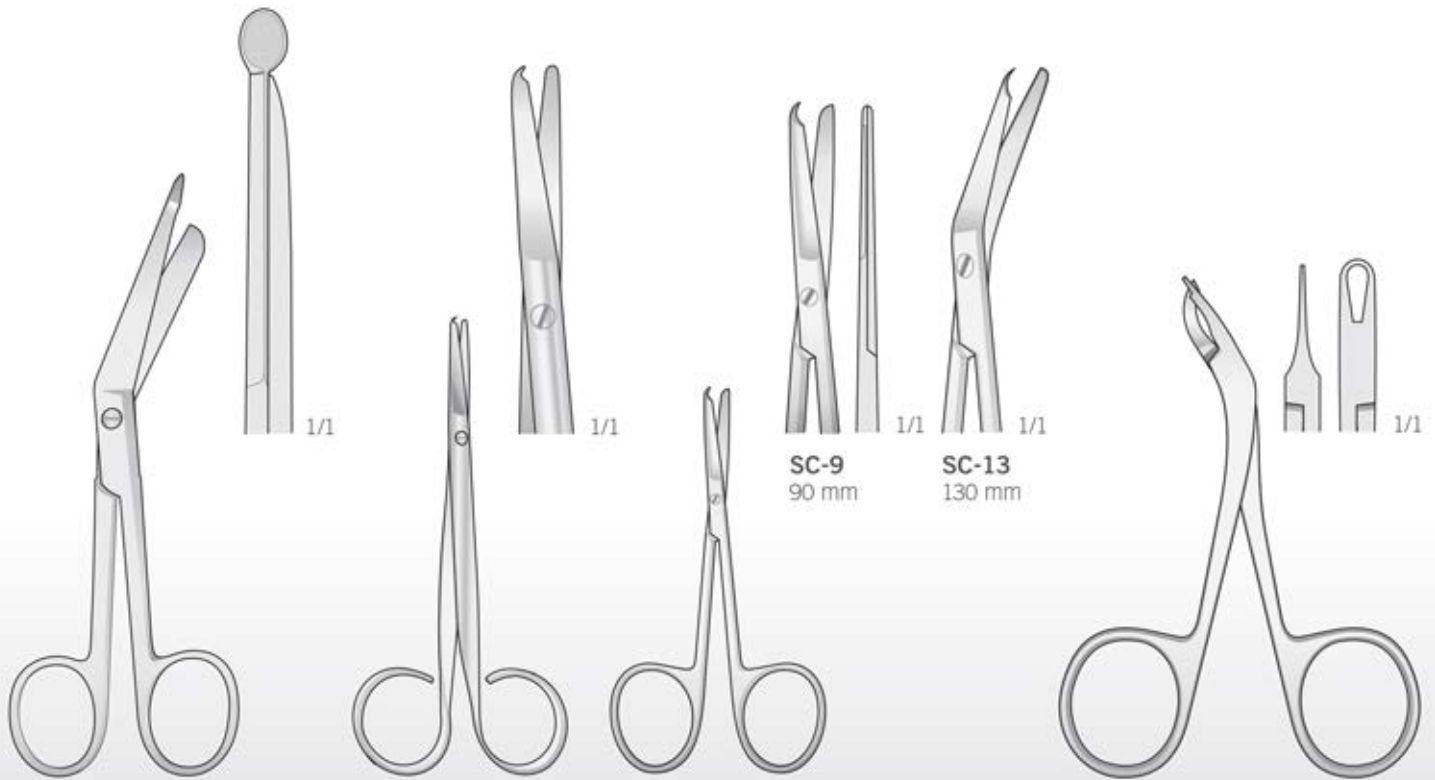

LISTER
FG-31 145 mm
FG-32 180 mm

SPENCER
SC-1
 110 mm

SPENCER
SC-9/SC-13

SC-9
 90 mm

SC-13
 130 mm

BF-64
 115 mm



TC

Mit Hartmetalleinsätzen - Mit einer Schneide gezahnt
 Tungsten-carbide scissors - With one blade serrated
 Forbici con lame al carburo di tungsteno - Con una lama dentellata
 Tijeras con placas de carburo de tungsteno - Con una hoja dentada
 Siseaux vec plaquettes en carbure de tungstène - Avec une lame dentée

Super Cut - TC

Mit Hartmetalleinsätzen - Mit einer Schneide gezahnt
 Tungsten-carbide scissors - With one blade serrated
 Forbici con lame al carburo di tungsteno - Con una lama zigrinata
 Tijeras con placas de carburo de tungsteno - Con una hoja dentada
 Siseaux vec plaquettes en carbure de tungstène - Avec une lame dentée

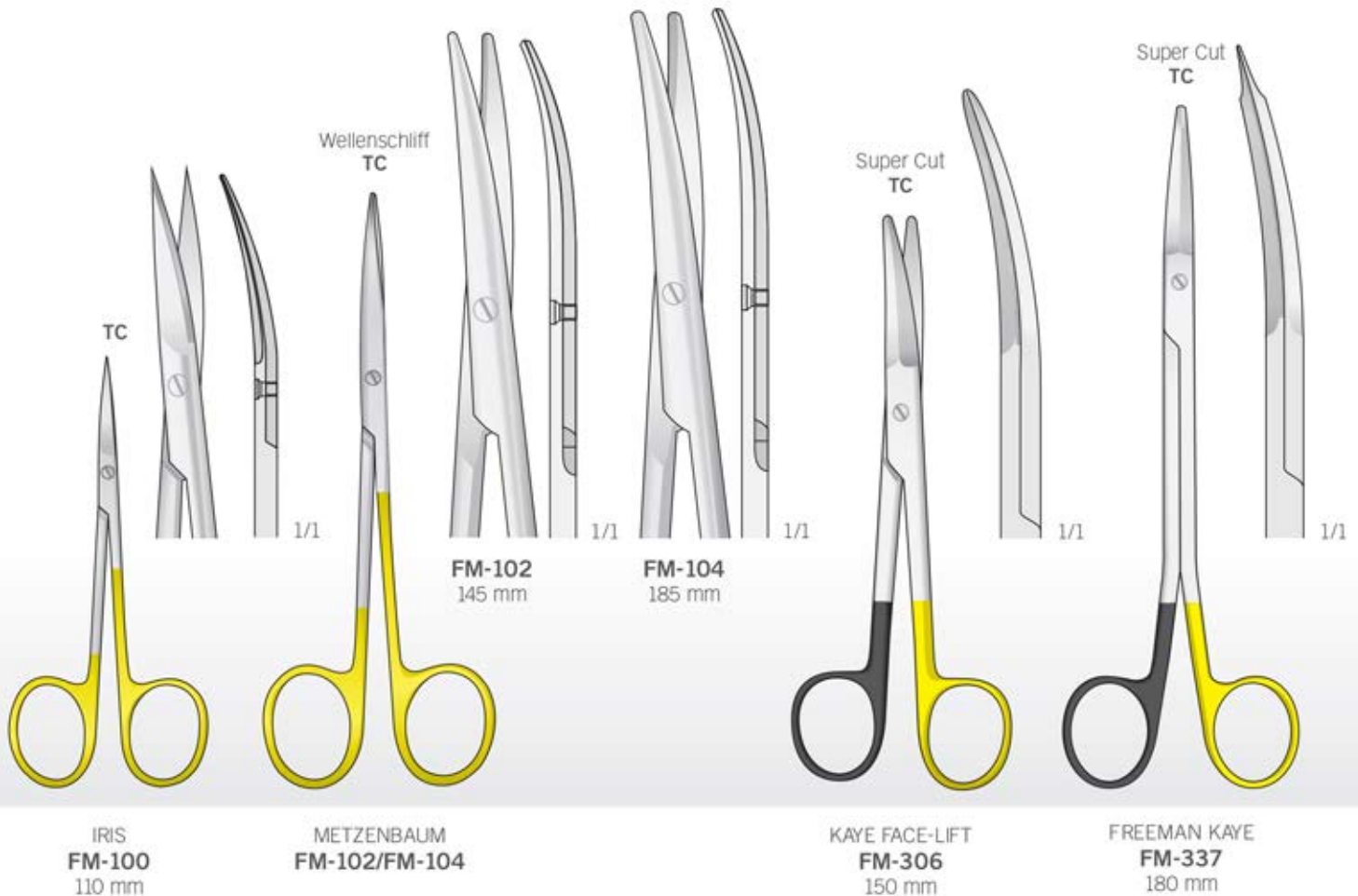



General Surgery
Allgemeine Chirurgie
Chirurgie générale
Cirugia General
Chirurgia Generale

Super Cut

Mit Hartmetalleinsätzen - Mit einer Schneide gezahnt
Tungsten-carbide scissors - With one blade serrated
Forbici con lame al carburo di tungsteno - Con una lama zigrinata
Tijeras con placas de carburo de tungsteno - Con una hoja dentada
Siseaux vec plaquettes en carbure de tungstène - Avec une lame dentée





ADSON

Chirurgische Pinzetten - Tissue Forceps
Pinzette chirurgiche - Pinzas quirúrgicas
Pincès chirurgicaux

Mit Hartmetalleinsätzen
Tungsten-carbide scissors
Con punta al carburo
di tungsteno
Con punta de carburo
de tungsteno
Avec plaquettes
en carbure de tungstène

Mit Fadenplatte
With tying platform
Con piano prendifilo
Con plataforma
Avec plateaux pour monofil

Micro

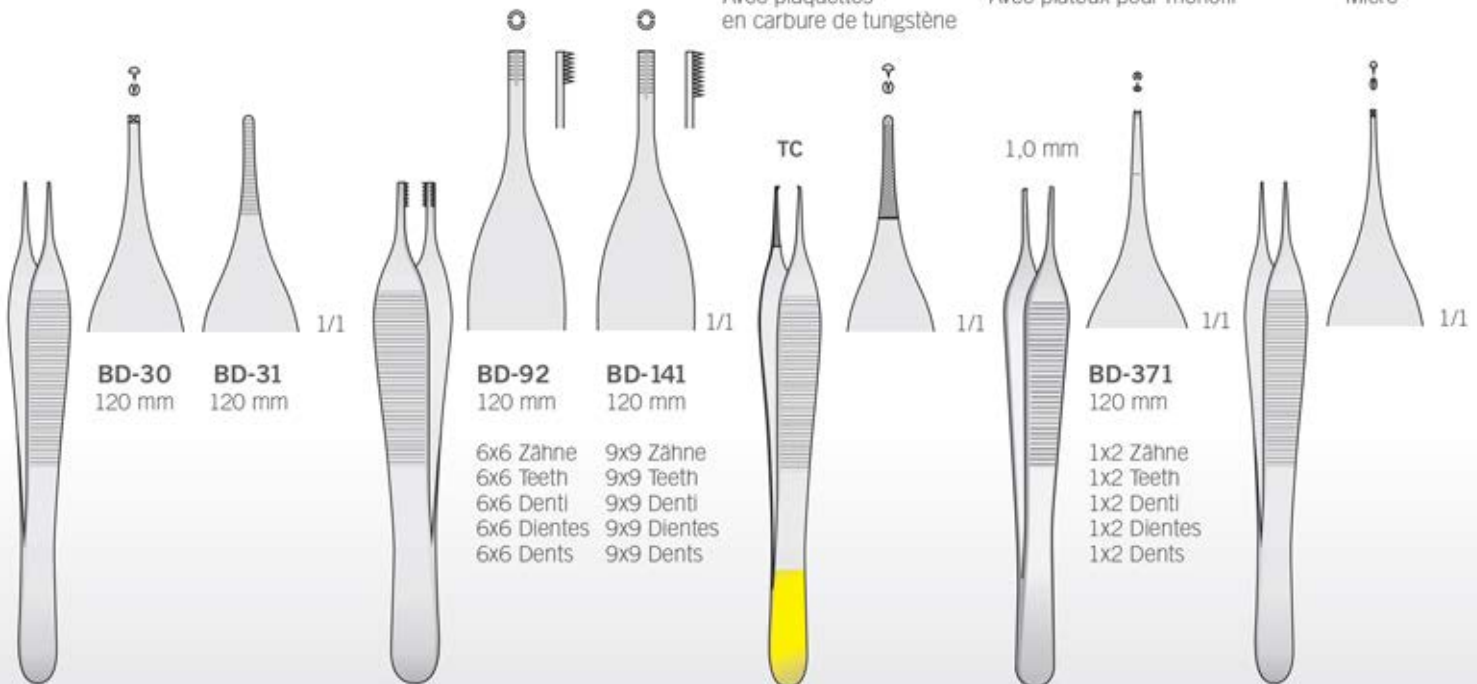

ADSON
BD-30/BD-31

ADSON-BROWN
BD-92/BD-141
120 mm

ADSON
BD-250
120 mm

ADSON
BD-371
120 mm

ADSON
BD-73
120 mm

Atraumatische pinzetten
 Non-traumatic vascular tissue forceps
 Pinzette atraumatische
 Pinzas atraumáticas
 Pincas atraumatiques

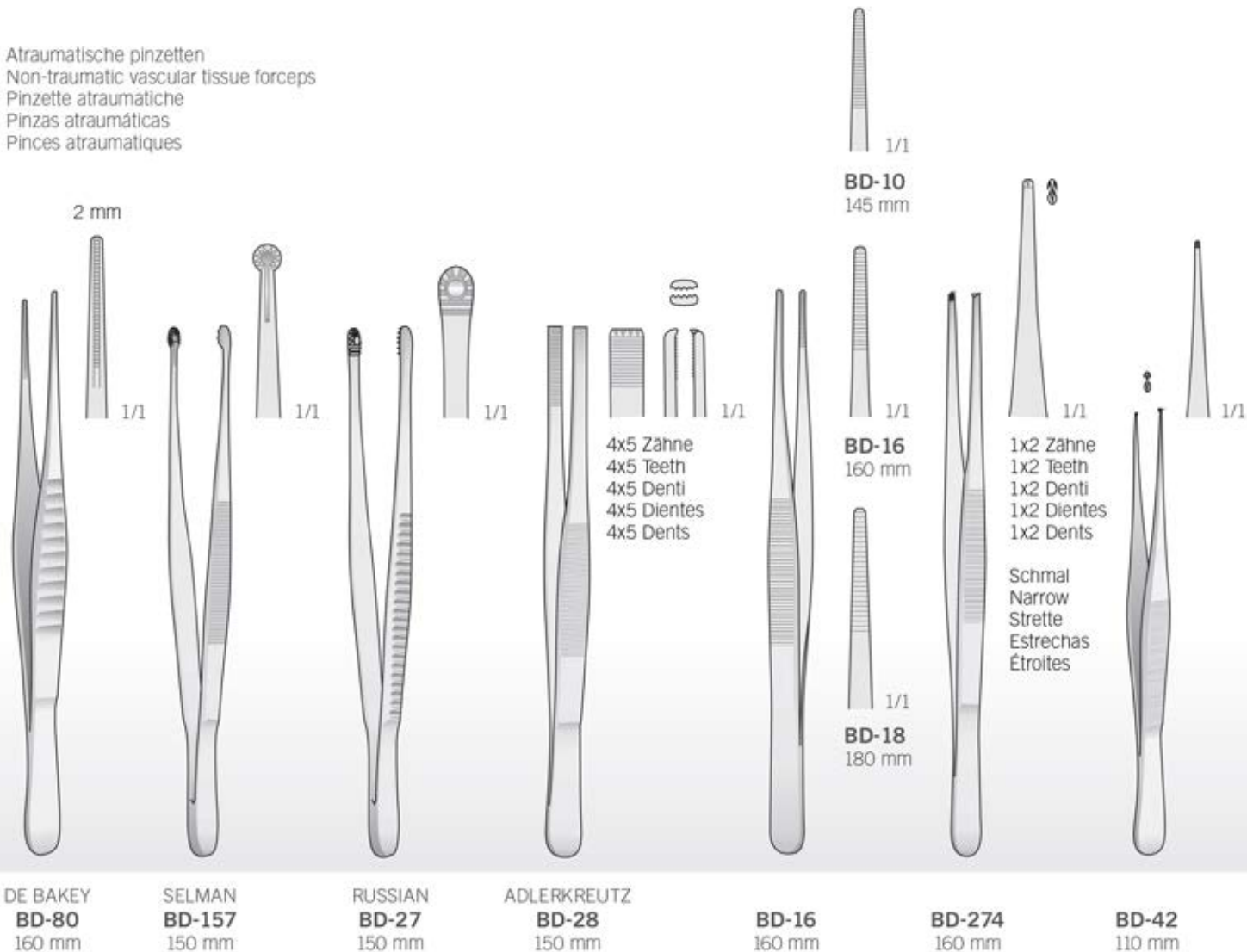

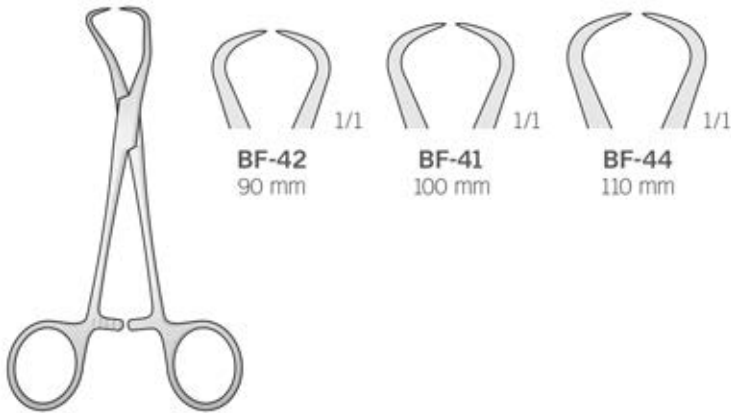

BACKHAUS
 BF-41/BF-44

BF-42 90 mm 1/1
 BF-41 100 mm 1/1
 BF-44 110 mm 1/1

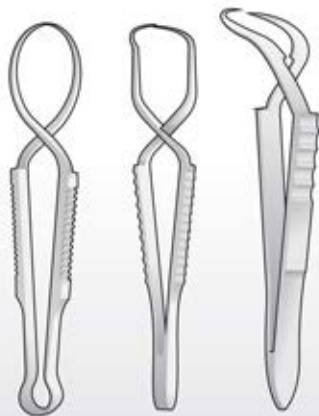

SCHAEDEL BF-38 85 mm
 FAURE BF-40 85 mm
 JONES BF-48 90 mm

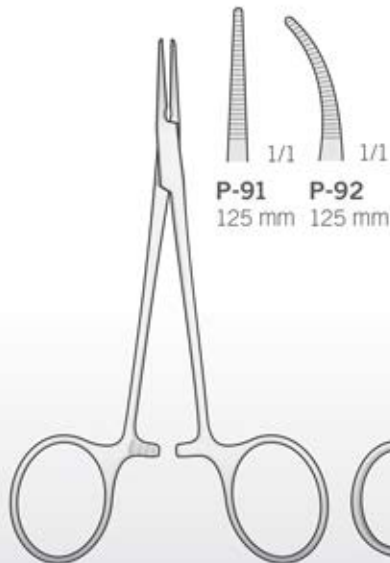

P-91 125 mm 1/1
 P-92 125 mm 1/1

HALSTED P-91/P-92 125 mm

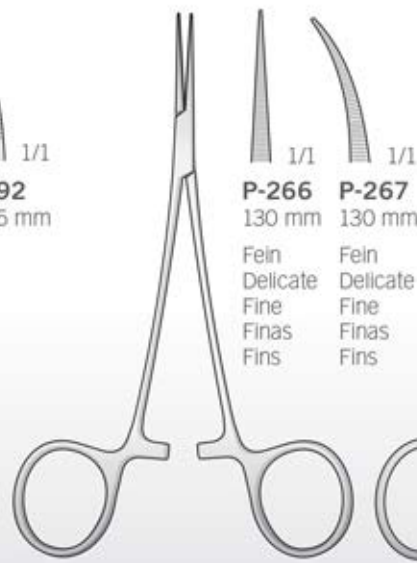

P-266 130 mm 1/1
 P-267 130 mm 1/1
 Fein Delicate
 Fine Fine
 Finas Finas
 Fins Fins

JACOBSON-MICRO P-266/P-267 130 mm

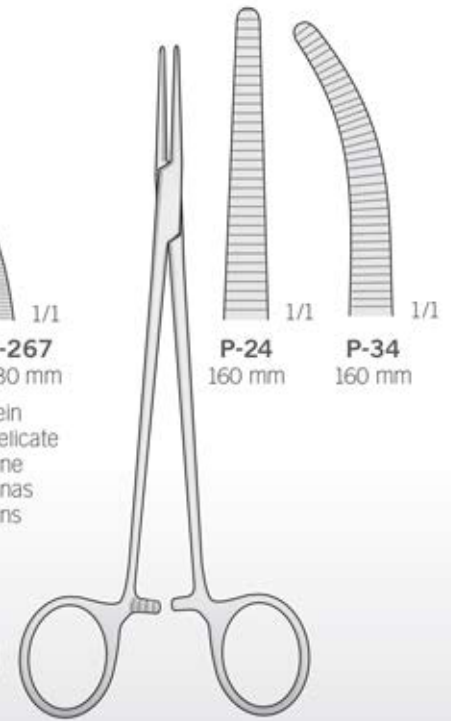

P-24 160 mm 1/1
 P-34 160 mm 1/1

PEAN P-24/P-34 160 mm



General Surgery
 Allgemeine Chirurgie
 Chirurgie générale
 Cirugía General
 Chirurgia Generale

Elastisch
 Elastic
 Elastiche
 Elásticas
 Elastic



Atraumatische
 Atraumatic
 Atraumatiche
 Atraumáticas
 Atraumatiques

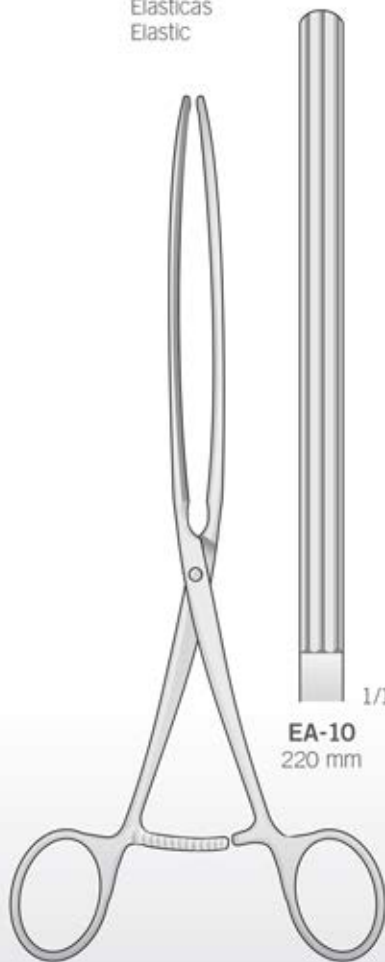

KOCHER
EA-10

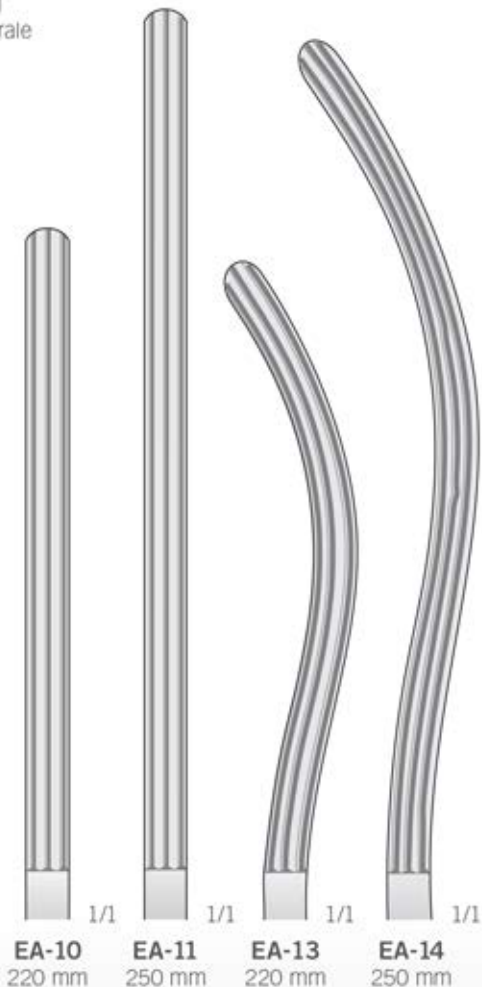

Darklemmen
 Intestinal Clamps
 Pinze intestinali
 Pinzas intestinales
 Pincas intestinales

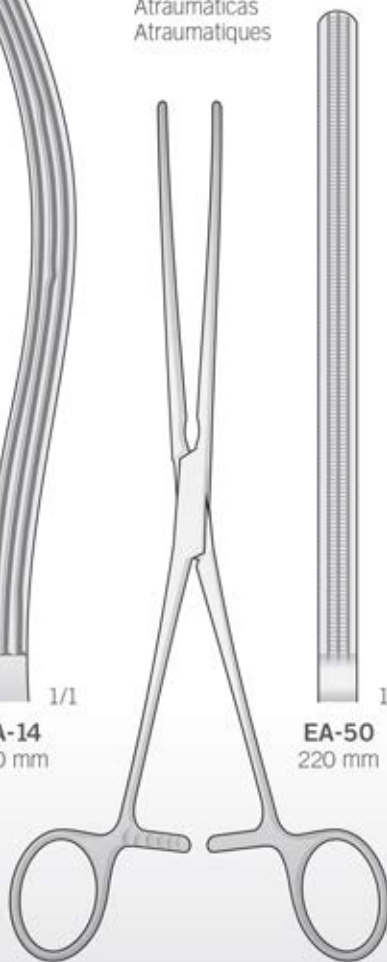

KOCHER
EA-53

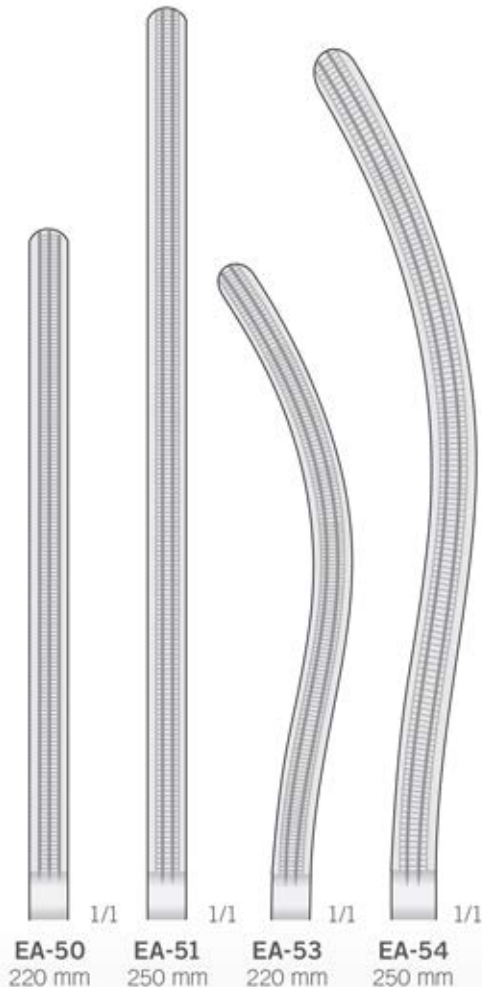

Darklemmen
 Intestinal Clamps
 Pinze intestinali
 Pinzas intestinales
 Pincas intestinales



Atraumatische
 Atraumatic
 Atraumatiche
 Atraumáticas
 Atraumatiques



COOLEY
FB-16
 160 mm

Atraumatische
 Atraumatic
 Atraumatiche
 Atraumáticas
 Atraumatiques

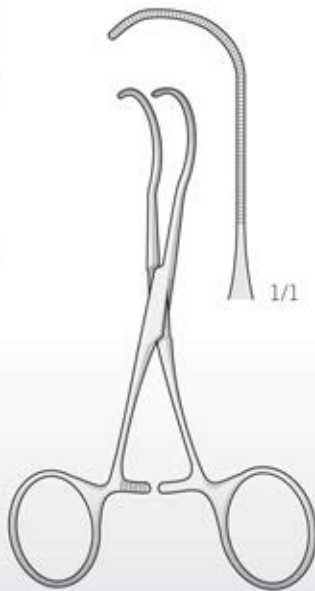

CASTANEDA
FB-256
 120 mm



Atraumatische
 Atraumatic
 Atraumatiche
 Atraumáticas
 Atraumatiques

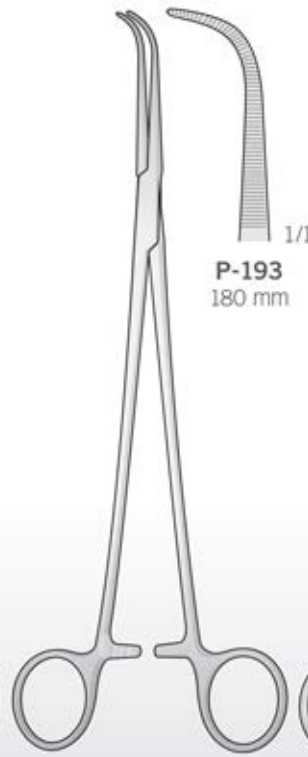

GEMINI
P-193

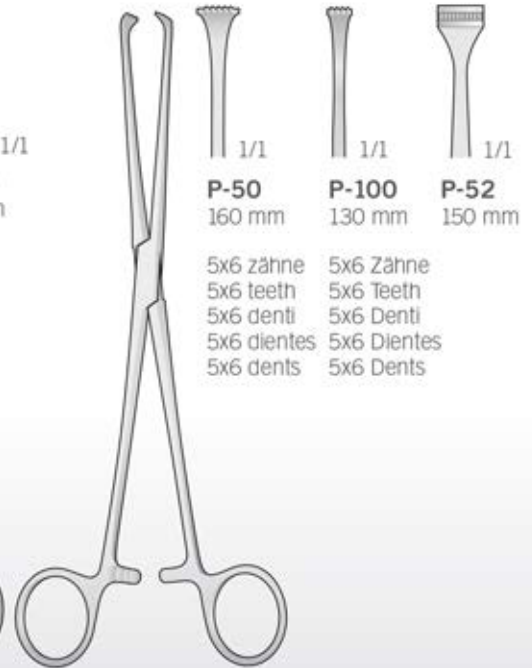

ALLIS
P-50/P-100



General Surgery
 Allgemeine Chirurgie
 Chirurgie générale
 Cirurgia General
 Chirurgia Generale

Absaugkanülen- Vacuums - Aspiratori
 Aspiradoras - Aspirateurs

- GF-75**
5x2 mm
190 mm 1/1
- GF-76**
6x2,5 mm
200 mm 1/1
- GF-77**
7x3 mm
200 mm 1/1

Fein-modell - Delicate Model
 Modello fine - Modelo delgada
 Mince modèle



- DB-120** L.85 mm
- DB-121** L.140 mm
- DB-122** L.165 mm



1/1

Ø 9 mm

Ø 8 mm

Ø 5,5 mm

HARTMANN
DB-120/DB-121/DB-122
 L. 85 mm

HARTMANN
DB-114
 140 mm

GF-75/GF-77
 200 mm

GF-09
 230 mm

POOLE
GF-29
 220 mm

POOLE
GF-22
 190 mm



Saug- und Spülinstrumente
 Aspirating and Irrigating Instruments
 Strumenti per aspirazione e lavaggio
 Instrumentos de aspiración y de lavado
 Instruments à aspiration et à irrigation

Ø 1,5 mm



OL-36
80 mm

Ø 1 mm



OL-22
50 mm

Ø 4 mm



SCHMID OL-31
150 mm

Ø 5 mm



SCHMID OL-32
150 mm

Ø 6 mm



SCHMID OL-33
150 mm

Ø 2 mm



VF-102
170 mm

Ø 4 mm



VF-102M
170 mm



PF-19
180 mm

Ø 1,5 mm



PF-22
145 mm

Knochenmark-Biopsie
 Marrow biopsy
 Biopsia del midollo
 Biopsia de médula
 Biopsie de la moelle

Haut-Trephinen
 Dermal punches
 Punche da biopsia
 Trépanos cutáneos
 Tréphines cutanées

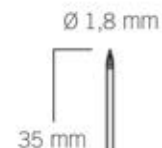

KLIMA-ROSEGGER OL-40
100 mm

Ø 1,8 mm

35 mm

5 mm



KEYES FL-152
100 mm

Ø 1 mm



HEPARIN OL-07
60 mm

Ø 1,5 mm



HEPARIN OL-08
60 mm



General Surgery
 Allgemeine Chirurgie
 Chirurgie générale
 Cirurgia General
 Chirurgia Generale

Empfohlen für Nähnadeln - Recommended for suture needles
 Raccomandato per aghi da sutura - Recomendado para agujas de sutura
 Recommandé pour les aiguilles à suture



Standard - Regular - Regolare
 Regular - Regulaire
2.0, 3.0, 4.0



Fein - Fine - Fine
 Fino - Fin
3.0, 4.0, 5.0, 6.0



Mikro - Micro - Micro
 Micro - Micro
6.0, 7.0, 8.0, 9.0



Glatt - Smooth - Liscia
 Lisa - Lisse
7.0, 8.0, 9.0, 10.0

Nadelhalter mit Hartmetalleinlagen - Needle Holders with tungsten-carbide inserts
 Portaghi con inserti al tungsteno - Portaagujas con placas de carburo de tungsteno
 Porte aiguilles avec plaquettes en carbure de tungstène

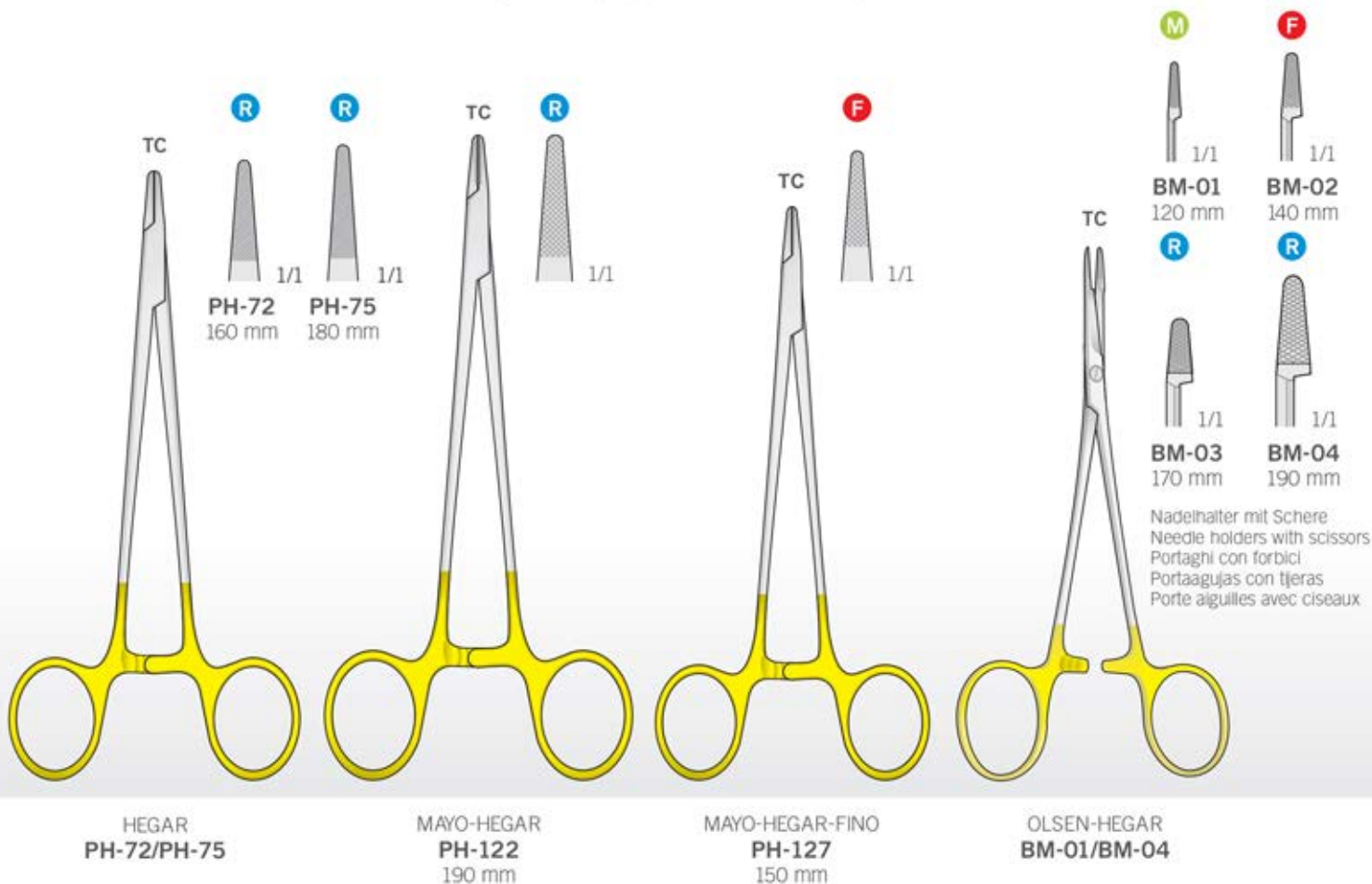

Empfohlen für Nähnadeln - Recommended for suture needles
 Raccomandato per aghi da sutura - Recomendado para agujas de sutura
 Recommandé pour les aiguilles à suture

R		Standard - Regular - Regolare Regular - Régulière 2.0, 3.0, 4.0	F		Fein - Fine - Fine Fino - Fin 3.0, 4.0, 5.0, 6.0
M		Mikro - Micro - Micro Micro - Micro 6.0, 7.0, 8.0, 9.0	S		Glatt - Smooth - Liscia Lisa - Lisse 7.0, 8.0, 9.0, 10.0

General Surgery
 Allgemeine Chirurgie
 Chirurgie générale
 Cirugía General
 Chirurgia Generale



Nadelhalter mit Hartmetalleinlagen - Needle Holders with tungsten-carbide inserts
 Portaghi con inserti al tungsteno - Portaagujas con placas de carburo de tungsteno
 Porte aiguilles avec plaquettes en carbure de tungstène

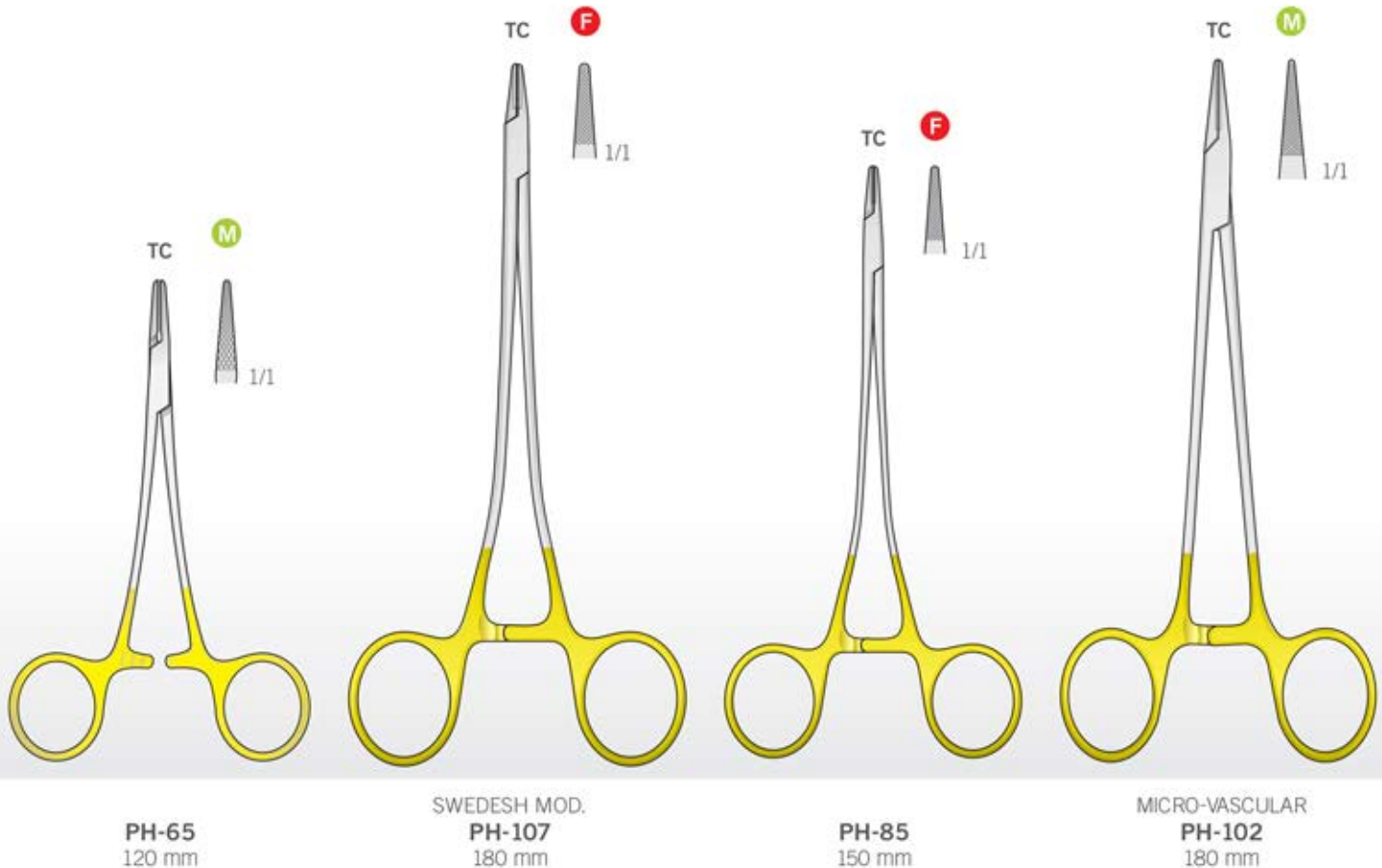



General Surgery
 Allgemeine Chirurgie
 Chirurgie générale
 Cirurgia General
 Chirurgia Generale

Empfohlen für Nähnadeln - Recommended for suture needles
 Raccomandato per aghi da sutura - Recomendado para agujas de sutura
 Recommandé pour les aiguilles à suture



Standard - Regular - Regolare
 Regular - Regulaire
2.0, 3.0, 4.0



Fein - Fine - Fine
 Fino - Fin
3.0, 4.0, 5.0, 6.0



Mikro - Micro - Micro
 Micro - Micro
6.0, 7.0, 8.0, 9.0



Glatt - Smooth - Liscia
 Lisa - Lisse
7.0, 8.0, 9.0, 10.0

Kräftiges Modell - Heavy pattern
 Modelo robusto - Modelo sólido
 Modèle robuste

Mit Schere - With Scissors
 Con Forbice - Con Tijeras
 Avec Ciseaux

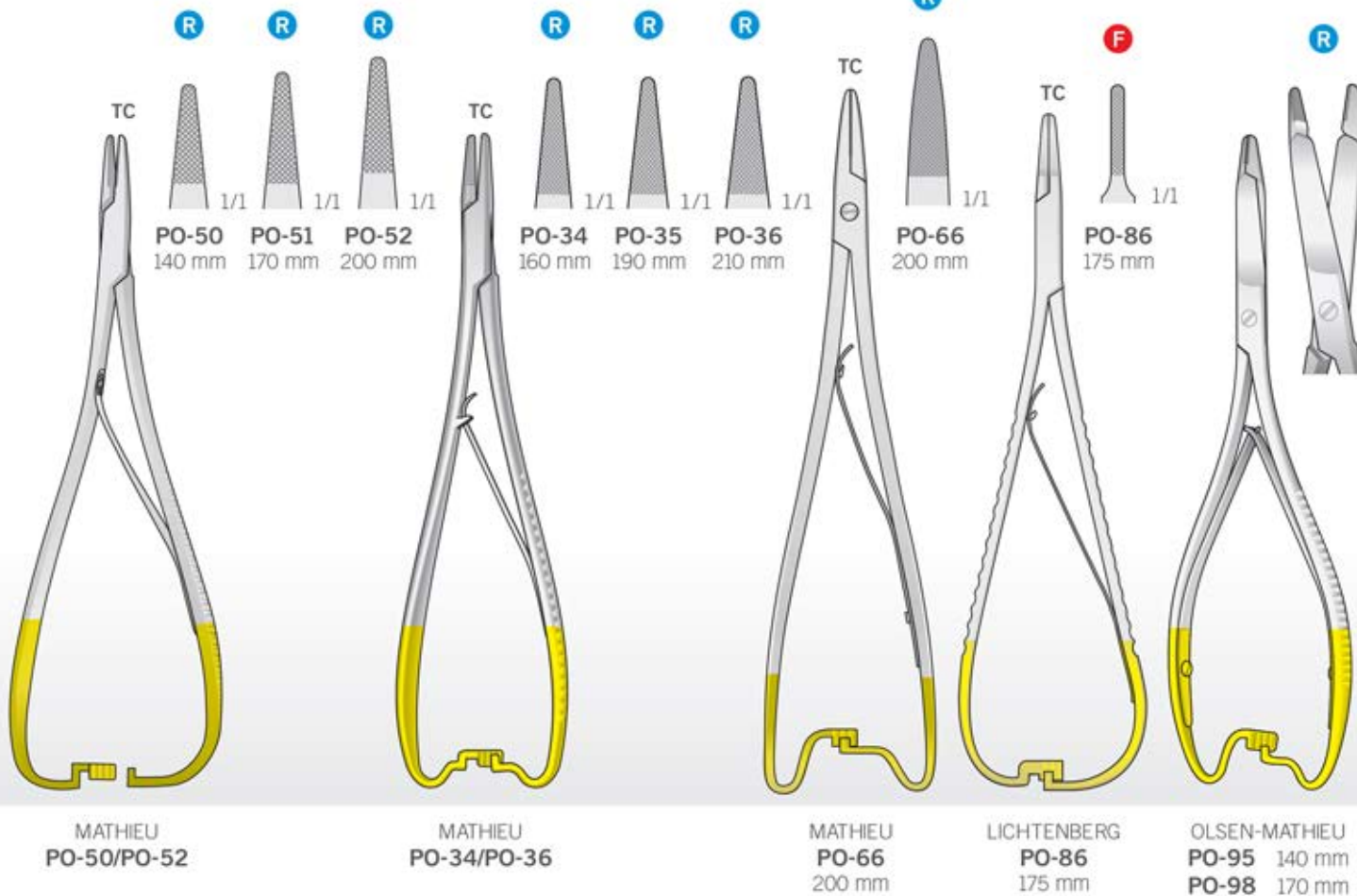

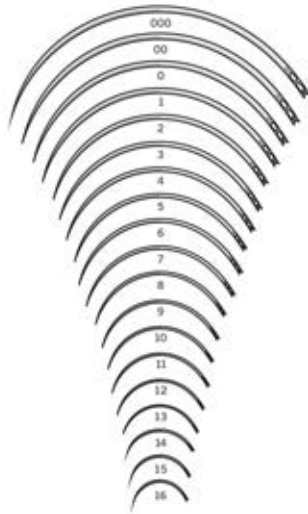

Art.	Eye	Profile
BN-502/000		▼
BN-502/00		▼
BN-502/0		▼
BN-502/1		▼
BN-502/2		▼
BN-502/3		▼
BN-502/4		▼
BN-502/5		▼
BN-502/6		▼
BN-502/7		▼
BN-502/8		▼
BN-502/9		▼
BN-502/10		▼
BN-502/11		▼
BN-502/12		▼
BN-502/13		▼
BN-502/14		▼
BN-502/15		▼
BN-502/16		▼

Färbige Ringe aus Silikon zu kodieren Chirurgie-Kits
 Colored rings in silicone to encode surgical kits
 Anelli colorati in silicone per codificare kit chirurgici
 Anillos de colores en silicona para codificar set quirúrgico
 Bagues colorées en silicone pour encoder des kits de chirurgie



DB-941 box 120 pcs.
DB-942 box 175 pcs.

Färbige Bänder
 Colored ribbons
 Nastri colorati per codificare kit chirurgici
 Cintas de colores
 Rubans colorés



DB-940
 box 8 colours

Mini-Wurzelheber
 Root Mini Elevators
 Mini Leve per radici
 Mini Elevadores para raíces
 Mini Elévateurs à racines

Luxatoren für Schneidezähne
 Incisors Luxators
 Lussatori per incisivi
 Luxadores para incisivos
 Luxateurs pour incisives

Erweitert Wange
 Widens Cheek
 Allargaguancia
 Amplía-mejilla
 Élargit la joue

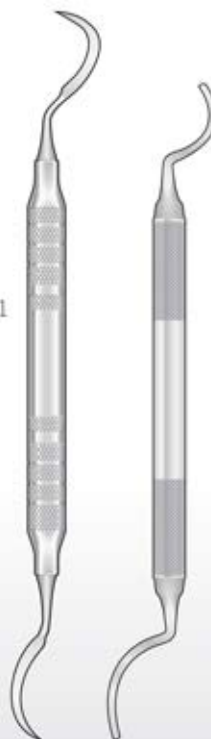

Mundsperrer
 Mouth Gags
 Apribocca
 Abreboca
 Ecateur buccal



VF-121
 60 mm

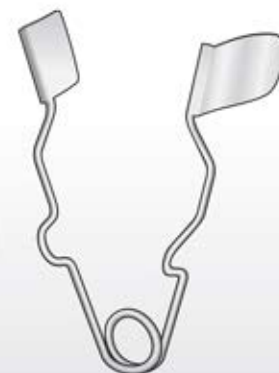

US DL-401
 155 mm

US DL-402
 155 mm

US DL-403
 155 mm

US DL-500
 130 mm

MIR-12
 155 mm

VF-127
 185 mm

VF-126
 160 mm

SCHMIDTKE
VF-120
 120 mm

VF-122
 85 mm

Katzen - Cats
Gatti - Gatos
Chats

VH-48 60 mm
VH-49 80 mm



Hunde - Dogs
Canis - Perros
Chiens

VH-50 110 mm
VH-51 160 mm

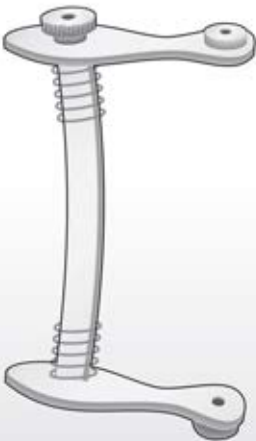

VH-48/VH-51

TC

Mit Hartmetalleinsätzen
With Hard Metal Inserts
Con punte in metallo duro
Con puntas de metal duro
Avec mors en métal dur

Zange zum Abkneifen
von Ferkeelzähnen
Forceps for trimming teeth
for small animals
Pinza per tagliare denti
di piccoli animali
Pinza para cortar dientes
de pequeños animales
Pincas à couper les dents
des petits animaux

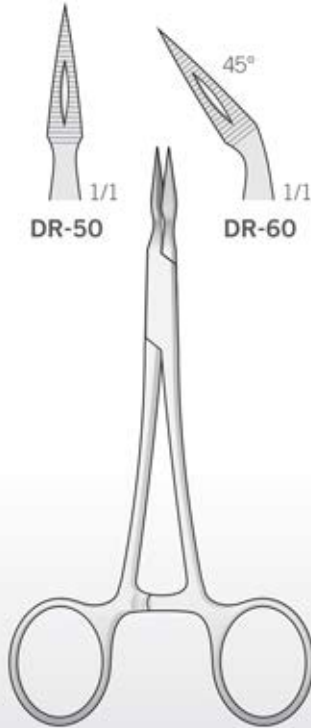

STIEGLITZ
DR-50/DR-60
140 mm



LX-98
175 mm



FREER
180 mm

Dental Surgery
Zahnärztliche Chirurgie
Chirurgie Dentaire
Cirugia Dental
Chirurgia Dentale

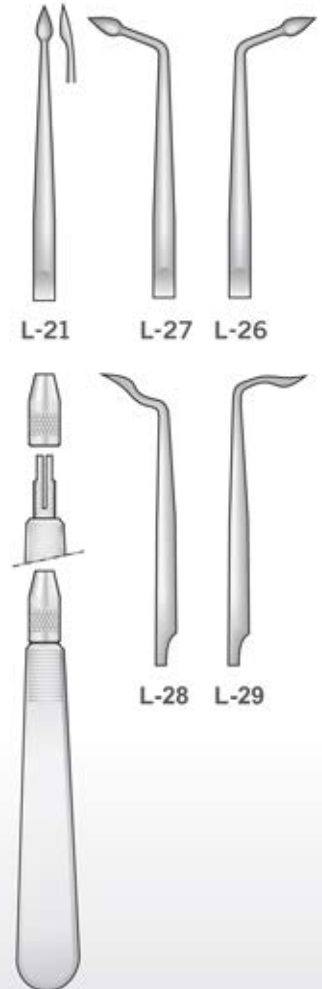

SD-M



2,2 mm

3,0 mm

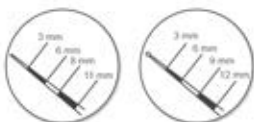

Eine Seite gezahnt
 One side serrated
 Un lato dentellato
 Un lado dentado
 Dentelure sur un côté

Rhodiumspiegel
 Rhodium Mirror
 Specchietto rodiato
 Espejo de rodio
 Miroir au rhodium



DL-78
155 mm



DL-79
155 mm



DA-02
130 mm



DA-01
130 mm



Pack. 12 pcs.

RH-4 22 mm



Massiv
 Solid
 Pieno
 Sólido
 Massif

Rostfrei
 Stainless
 Inox
 Inoxidable
 Inoxydable

FAHRENKRUG
DL-05
190 mm

FAHRENKRUG
DL-06
190 mm

CP-11
SM-11
160 mm

CP-12S
SM-13
160 mm

DL-78/DL-79
155 mm

DA-01/DA-02
130 mm

MA-2
125 mm



Wurzelheber
 Root Elevators
 Leve per radici
 Elevadores para raíces
 Élévateurs à racines

Luxatoren
 Luxators
 Lussatori
 Luxadores
 Luxateurs

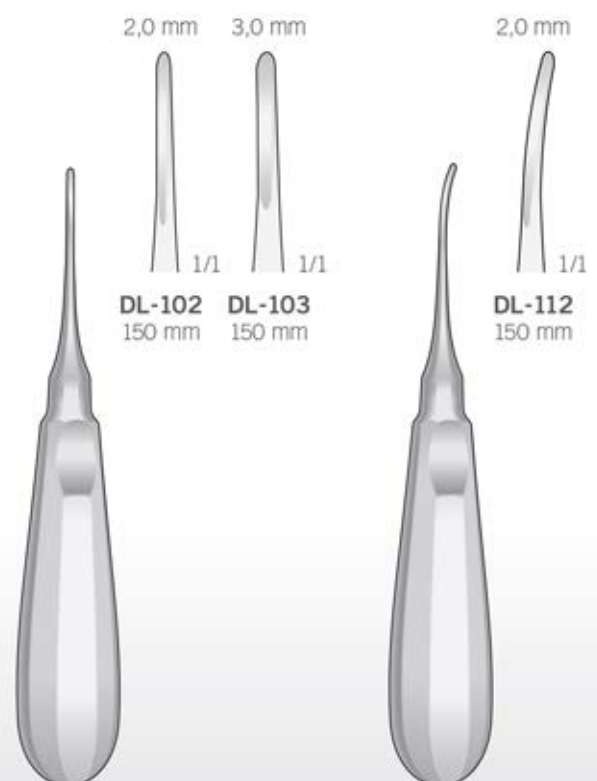
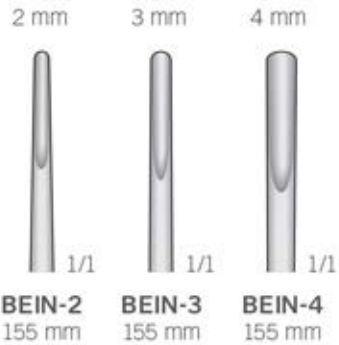

BEIN-2/BEIN-4
155 mm

BEIN-2Z
155 mm

DL-102/DL-103
150 mm

DL-112
150 mm



56

Zum Trennen Unterer Molarenwurzeln
 For separating lower molar roots
 Per radici dei molari inferiori, presa in profondità
 Para separar raíces de molares inferiores profundos
 Pour séparer les racines des molaires inférieures



1

Obere Schneide
 und Eckzähne

Upper Incisors
 and cuspids

Incisivi e canini
 superiori

Incisivos y caninos
 superiores

Incisives et canines
 supérieures



30

Obere Wurzeln

Upper Roots

Radici superiori

Raíces superiores

Racines supérieures



49

Obere Wurzeln
 sehr feine

Upper very
 fine roots

Radici superiori
 molto sottili

Raíces superiores
 muy finas

Racines supérieures
 très fines



PEB-5

Untere Schneidezähne
 Lower incisors
 Incisivi inferiori
 Incisivos inferiores
 Incisives inférieures

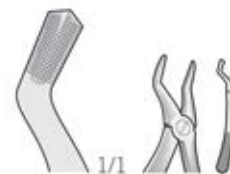

PEB-3

Obere Molaren
 Upper molars
 Molari superiori
 Molares superiores
 Molaires supérieures



PEB-2

Obere Prämolaren
 Upper Premolars
 Premolari superiori
 Premolares superiores
 Prémolaires supérieures



PEB-1

Obere Schneidezähne
 Upper Incisors
 Incisivi superiori
 Incisivos superiores
 Incisives supérieures



Universal Küretten
 Universal Curettes
 Curette universali
 Curetas universales
 Curettes universelles

Küretten
 Curettes
 Curette
 Curetas
 Curettes

Scaler

Periotome
 Periotomes
 Periotomi
 Periostótomos
 Périotomes

Ø 8.0 mm

Ø 8.0 mm

Ø 8.0 mm



Spitz
 Sharp
 Acuta
 Agudas
 Pointu



Stumpf
 Blunt
 Smussa
 Romas
 Mousse



Spitz
 Sharp
 Acuta
 Agudas
 Pointu



GRACEY
 CU-1/2



GRACEY
 CU-3/4



718-M23
 165 mm

718-M23A
 165 mm

718-M23B
 170 mm

GRACEY
CU-1/2/CU-3/4

GOLDMAN-FOX
718-277

TOWNER-
 JAQUETTE
719-111

MC-11
 160 mm

MC-12
 160 mm

MC-13
 160 mm

Dental Surgery
 Zahnärztliche Chirurgie
 Chirurgie Dentaire
 Cirugia Dental
 Chirurgia Dentale

Periostale
 Periosteal
 Scollatori
 Perióstica
 Décolleur

Scharf
 Sharp
 Taglienti
 Afilado
 Tranchant

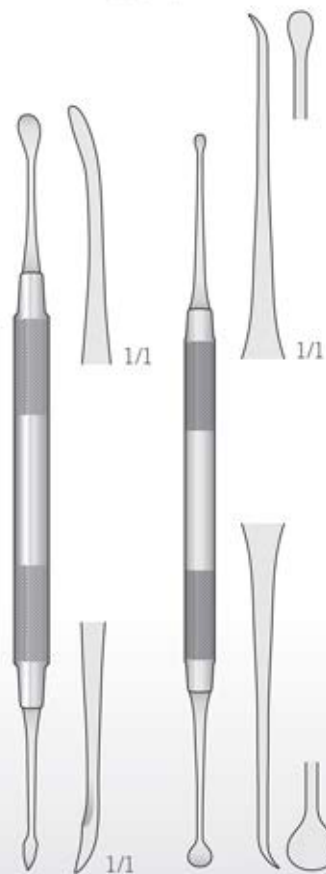

MOLT MO-8
185 mm

MOLT MO-10
180 mm



R-2

R-3

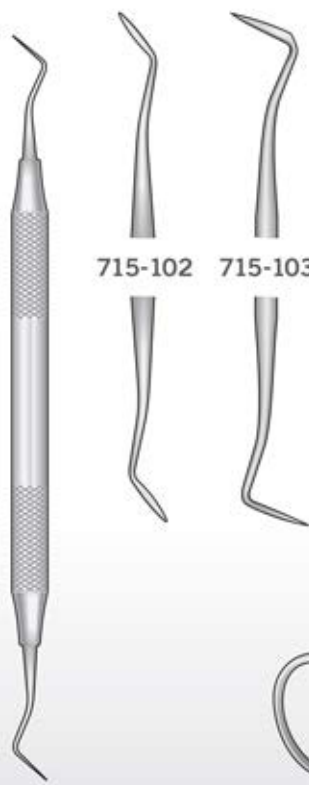

HOLLENBACK
715-102
715-103

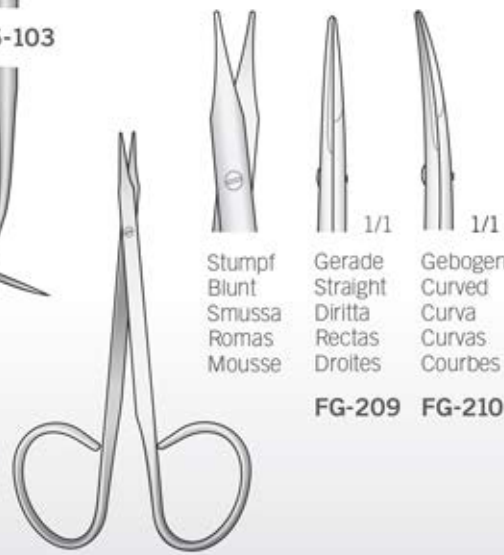

STEVENS
FG-209/FG-210
100 mm

Stumpf
 Blunt
 Smussa
 Romas
 Mousse

Gerade
 Straight
 Diritta
 Rectas
 Droites

Gebogen
 Curved
 Curva
 Curvas
 Courbes

FG-209 FG-210



OR-17 - 90 mm
 Meßbereich: 0 - 20 mm
 Measuring range: 0 - 20 mm
 Campo di misura: 0 - 20 mm
 Alcance de medición: 0 - 20 mm
 Etendue de mesure: 0 - 20 mm

OR-12 - 170 mm
 Meßbereich: 0 - 40 mm
 Measuring range: 0 - 40 mm
 Campo di misura: 0 - 40 mm
 Alcance de medición: 0 - 40 mm
 Etendue de mesure: 0 - 40 mm

CASTROVIEJO
OR-12/OR-17

Augenlid
 Eyelid
 Blefarostati
 Párpado
 Paupière

Stumpf
 Blunt
 Smussa
 Romo
 Mousse



FD-64 1/1

Stumpf
 Blunt
 Smussa
 Romo
 Mousse



FD-41 1/1

Hornhaut Schere
 Corneal scissors
 Forbici corneali
 Tijeras de córnea
 Corneal ciseaux

Universal
 Universal
 Universale
 Universal
 Universel

NK-80	27 mm	5 mm
NK-82	34 mm	9 mm
NK-84	42 mm	12 mm
NK-86	42 mm	14 mm

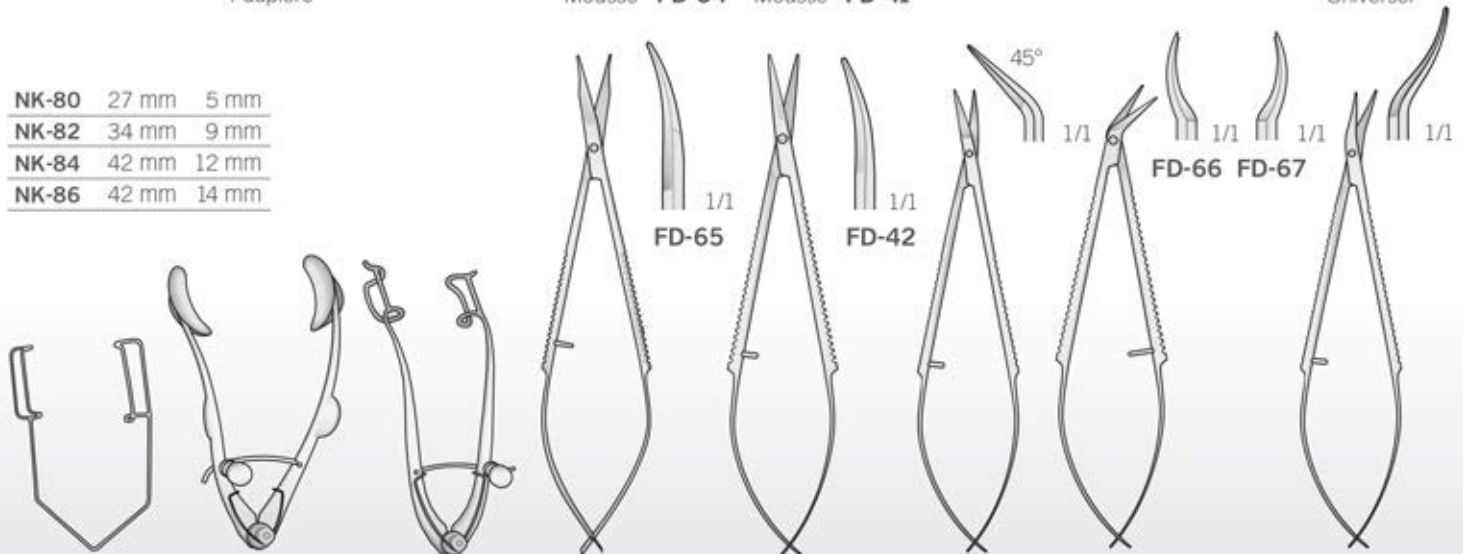

BARRAQUER
NK-80/NK-86
 52 mm

LISTER-BURCH
BV-04
 80 mm

WILLIAMS
BV-06
 80 mm

WESTCOTT
FD-64/FD-65
 120 mm

FD-41/FD-42
 120 mm

FD-11
 110 mm

CASTROVIEJO
FD-66/FD-67
 110 mm

CASTROVIEJO
FD-68
 110 mm



Ophthalmology
Ophthalmologie
Ophtalmologie
Ofthalmologia
Ofthalmologia

Ohne Sperre
Without Lock
Senza arresto
Sin cierre
Sans Arrêt

Atraumatische
Atraumatic
Atraumatiche
Atraumáticas
Atraumatiques

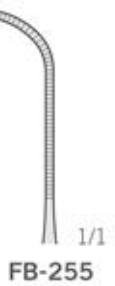
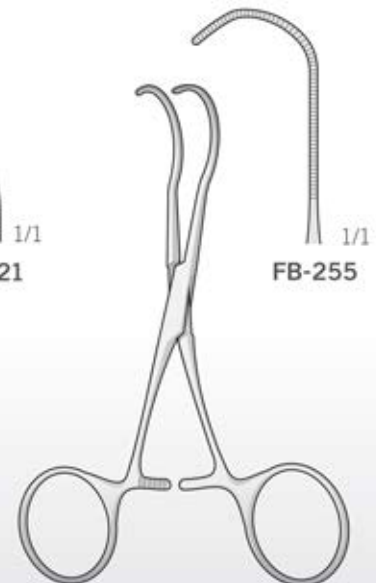
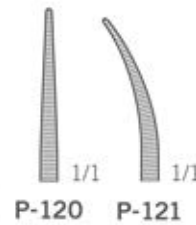
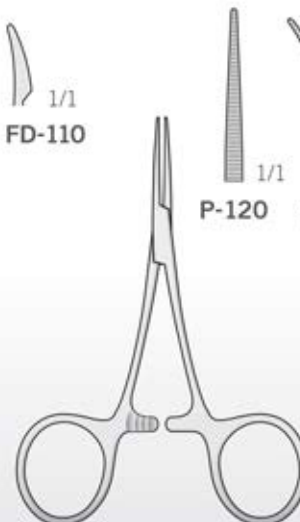
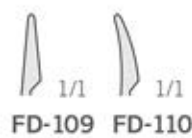

CASTROVIEJO
FD-105/FD-108
110 mm

CASTROVIEJO
FD-109/FD-110
125 mm

HARTMANN-BABY-MOSQUITO
P-120/P-121
95 mm

CASTANEDA
FB-255
120 mm

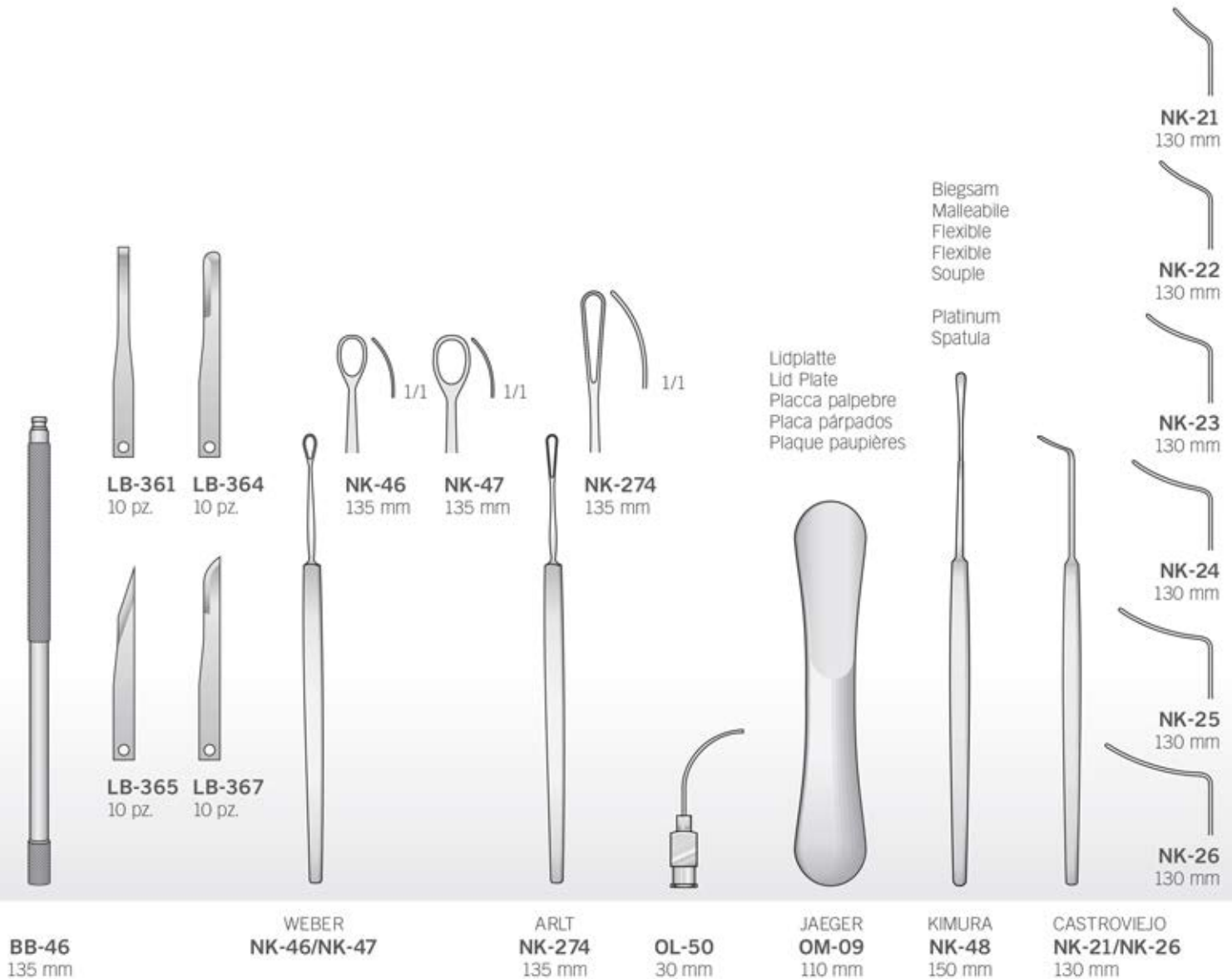



Ophthalmology
Ophthalmologie
Ophtalmologie
Ofthalmologia
Ofthalmologia

Pinzetten dritte Augenlid
Tweezers third eyelid
Pinza terza palpebra
Pinzas párpado tercero
Pinces troisième paupière

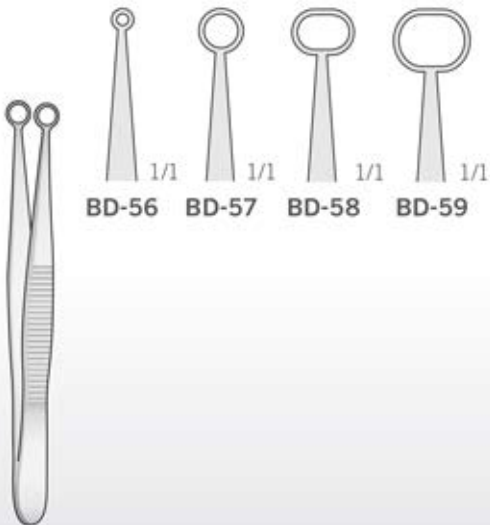

BD-56/BD-59
100 mm

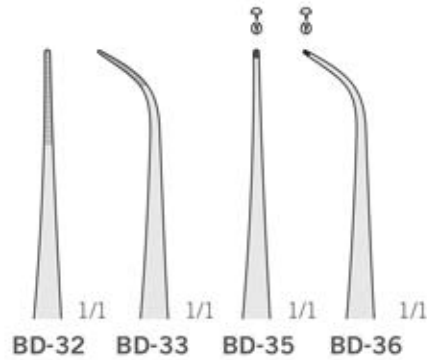

Iris Pinzetten
Iris Forceps
Pinze da iride
Pinza para iris
Pince à iris

BD-32/BD-36
100 mm

Chalazionpinzetten
Chalazion Forceps
Pinzette da calazio
Pinzas para chalación
Pinces à chalazion

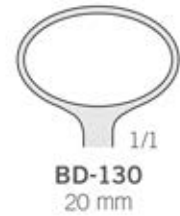

BD-130
20 mm



BD-131
26 mm



BD-132
31 mm

DESMARRES
BD-130/BD-132
90 mm



Fixierpinzetten
 Fixation forceps
 Pinze da Fissazione
 Pinzas de fijaci3n
 Pincas à fixer

Mit Stop
 With Stop
 Con arresto
 Con parada
 Avec arrêt

Tying Forceps
 delicate 5 mm
 long platform
 for 7-0 to
 9-0 sutures

Tying & Utility
 Forceps standard
 7 mm long platform
 for sutures
 below 7-0

Suturing Forceps
 1x2 teeth
 of 0,3 mm set
 at 45° with delicate
 platform

Universal Suturing
 Forceps
 1x2 teeth of
 0,7 mm set at 45°
 with heavy platform



0,4 mm

0,25 mm

1/1

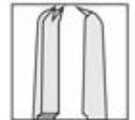
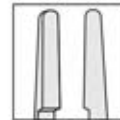
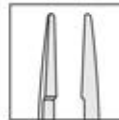

GRAEFE
BD-135
 110 mm

GRAEFE
BD-136
 110 mm

COLIBRI
NK-66
 75 mm

COLIBRI
NK-69
 80 mm

St. MARTIN
MF-200
 85 mm

PAUFIQUE
MF-201
 88 mm

St. MARTIN
MF-205
 85 mm

PAUFIQUE
MF-206
 88 mm



Traumatology - Orthopaedics

Traumatologie - Orthopädie

Traumatologie - Orthopédie

Traumatologia - Ortopedia

Traumatologia - Ortopedia



- Max Ø 0.7 mm (.028")
- 1.30 x 0.65 mm (.052" x .026")

Für weichen und harten Draht
 For soft and hard Wire
 Per filo leggero e duro
 Para alambre blando y duro
 Pour fil léger et dur

Universalzange
 Universal Pliers
 Pinze universali
 Alicates universales
 Pincas universelles

Rostfrei
 Stainless Steel
 Acciaio Inox
 Acero Inoxidable
 Acier Inoxydable

Parallel-Flachzange mit Seitenschneider
 Flat-nose pliers parallel with lateral wire cutter
 Pinza a branche parallele con tronchese
 Alicates de ramas paralelas con corta-alambre lateral
 Caliper branches en parallèle avec des coupe

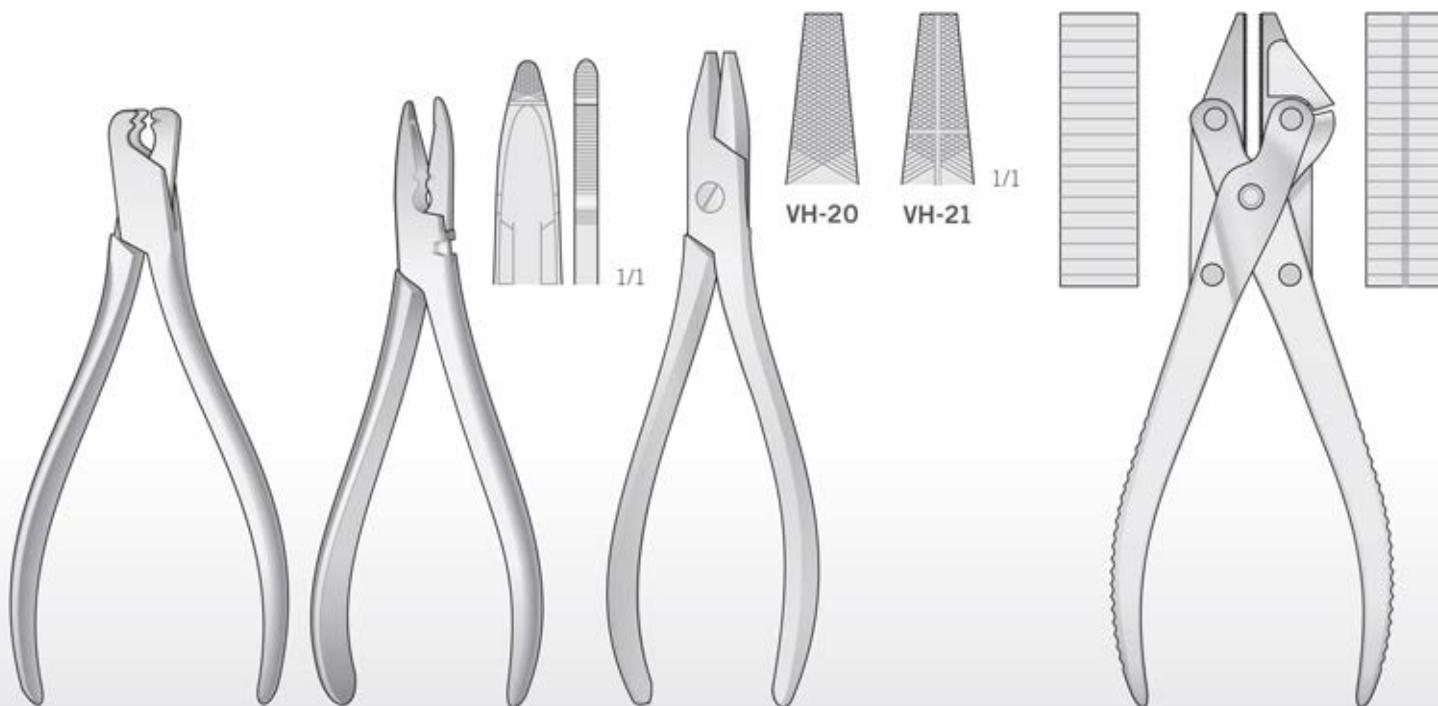

ADERER
DP-41
 145 mm

WALDSACHS
DP-84
 150 mm

VH-20/VH-21
 175 mm

LX-80
 185 mm

Traumatology - Orthopaedics

Traumatologie - Orthopédie

Traumatologie - Orthopédie

Traumatologia - Ortopedia

Traumatologia - Ortopedia



Für Lig. Femurkopf
For ligament femoral head
Per legamenti testa del femore
De la cabeza femoral del ligamento
Pour les ligaments tête femore



LX-131
180 mm

**LUCAE
FL-10M**
190 mm



**ROSIN
DL-58**
160 mm



**SENN-MILLER
BT-18/BT-19**
160 mm



**SCHMIEDEN-DICK
BM-17**
320 mm

BT-18
Spitz
Sharp
Acuto
Agudo
Pointu

BT-19
Stumpf
Blunt
Smusso
Romo
Mousse

Malleabile
Flexible
Biegsam
Souple
Maleable



Traumatology - Orthopaedics

Traumatologie - Orthopädie

Traumatologie - Orthopédie

Traumatologia - Ortopedia

Traumatologia - Ortopedia

BV-108

Spitz

Scharp

Acuto

Agudo

Pointu

BV-109

Stumpf

Blunt

Smusso

Romo

Mousse



GELPI
BV-14
90 mm



GELPI
BV-14M
90 mm



GELPI
BV-15
110 mm



GELPI
BV-16
140 mm

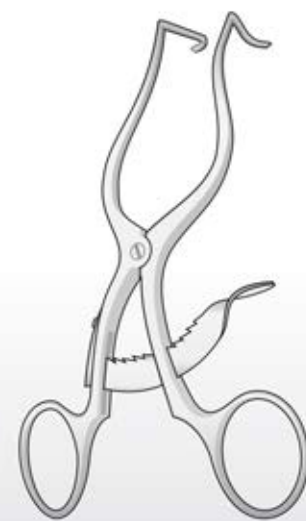

CLOWARD-CONTOUR
BV-108/BV-109
140 mm

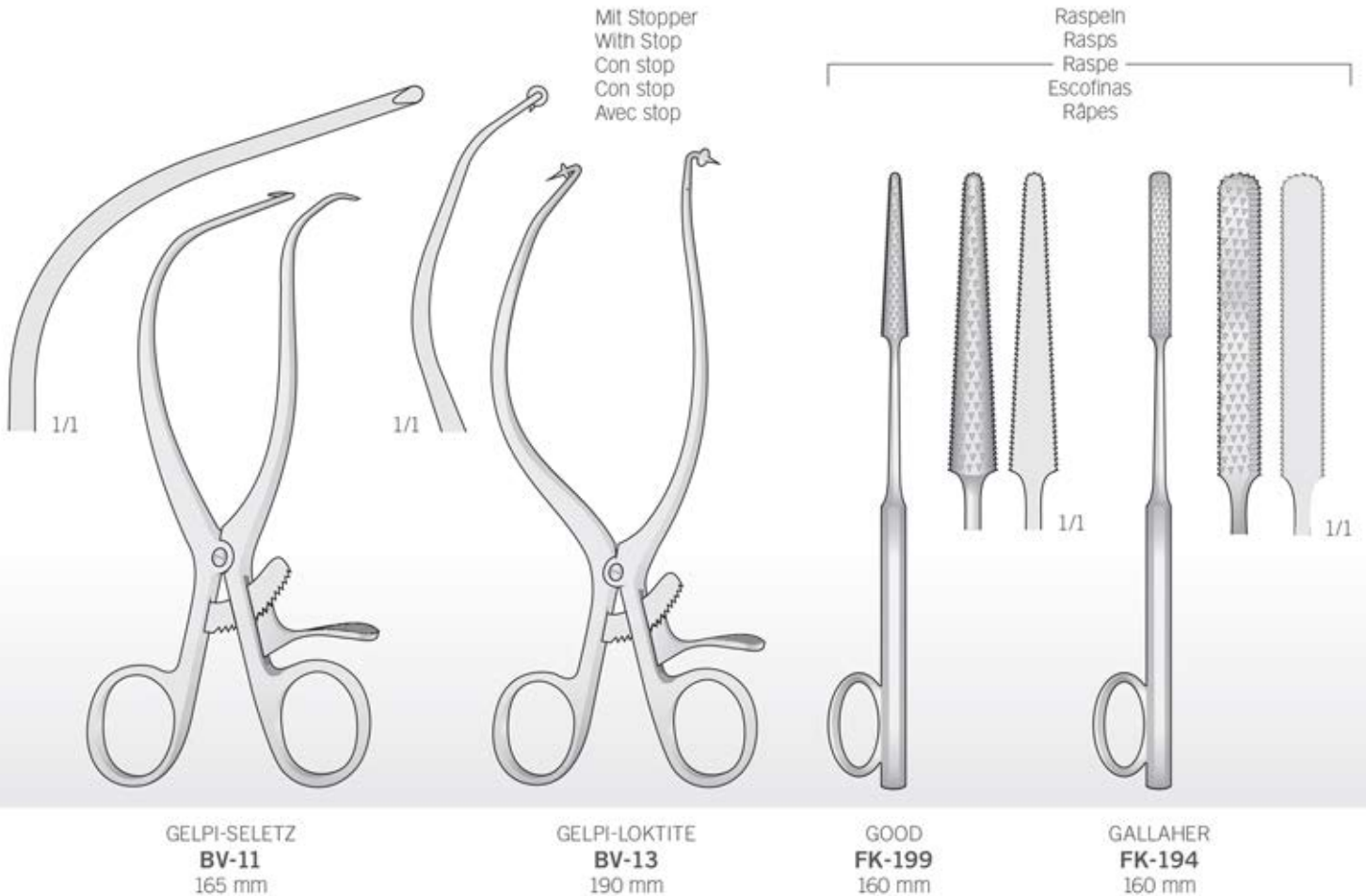

Traumatology - Orthopaedics

Traumatologie - Orthopädie
 Traumatologie - Orthopédie
 Traumatologia - Ortopedia
 Traumatologia - Ortopedia

Raspatorien
 Periosteal Raspatories
 Periostotomi
 Legras periostótomos
 Rugines à périostomie

Knochensägen
 Bone saws
 Seghetti per osso
 Sierra para huesos
 Scies à os

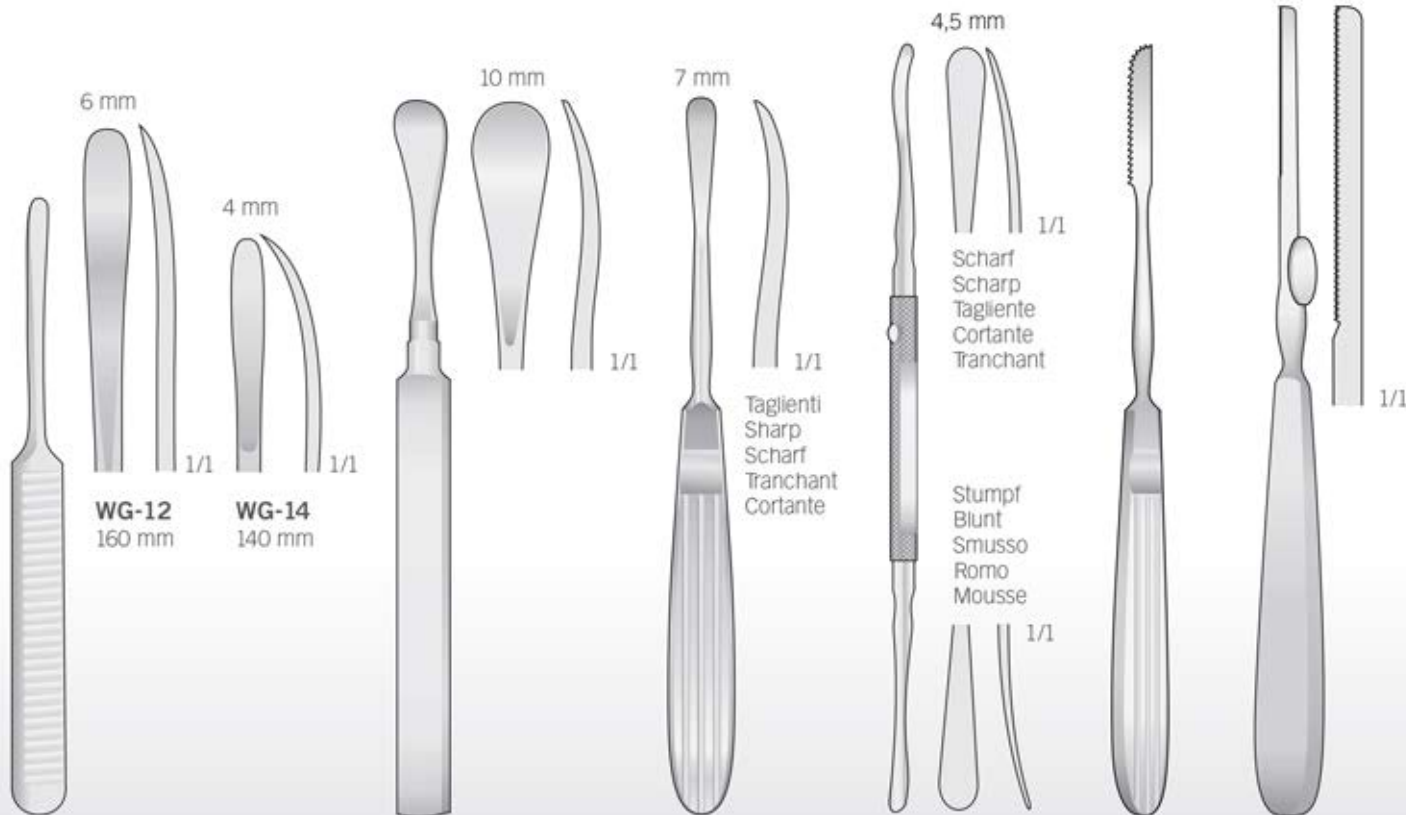

WILLIGER
WG-12/WG-14

HENAHAN
BT-05
 175 mm

OBWEGESER
DO-63
 175 mm

FREER
 180 mm

DO-267
 190 mm

LINDEMANN
FK-243
 200 mm

FL-90

Komplettset mit - Set complete with
Set completo di - Set completo con
Set complet avec

Mit Ferrozellgriff	4 Klängen
With Ferrozell handle	4 Blades
Manico portalamo in ferrozell	4 Lame
Con mango de Ferrozell	4 Hojas
Avec poignée en Ferrozell	4 Lames

Traumatology - Orthopaedics

Traumatologie - Orthopédie
Traumatologie - Orthopédie
Traumatologia - Ortopedia
Traumatologia - Ortopedia

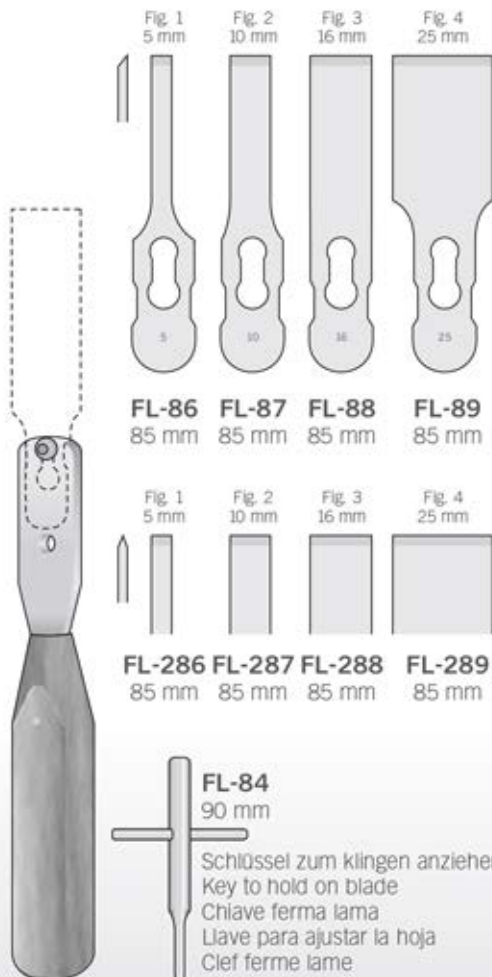

76 x 25 mm

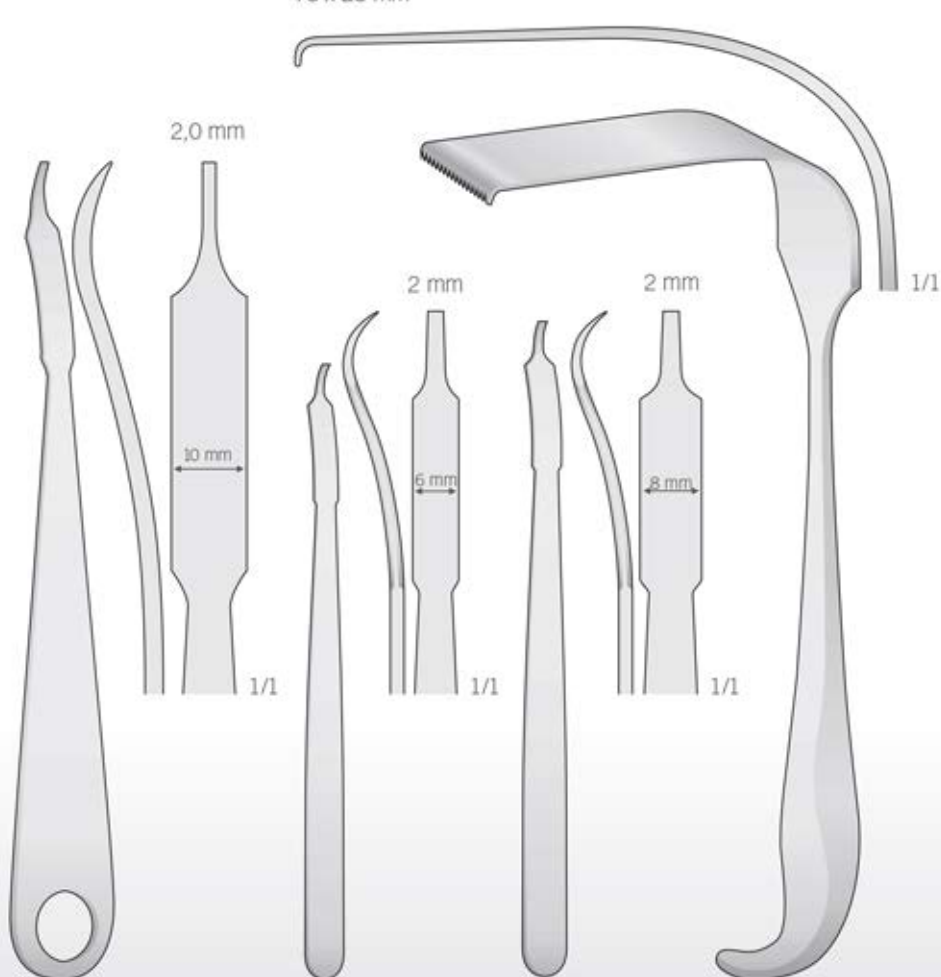

FL-85
190 mm

FK-51
220 mm

MINI-HOHMANN
FK-48
160 mm

MINI-HOHMANN
FK-49
160 mm

MEYERDING
BT-98
230 mm

Traumatology - Orthopaedics

Traumatologie - Orthopédie

Traumatologia - Ortopedia

Traumatologia - Ortopedia

Traumatologia - Ortopedia

Von Hand zu spannen

Tightened by hand

Con chiusura a mano

Cerrado a mano

Serré à la main

Inox
Spannbereich
0 - 3 mm



LS-222

Inox
Spannbereich
0,8 - 6 mm



LS-224

Inox
ORIGINAL JACOBS
Ø 10 mm



LS-236
50 mm

AO Attack

Ø 3,5 mm



LS-227
40 mm

Ø 3,5 mm

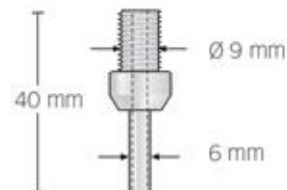

LS-228
40 mm

Canulato



LS-320
145 mm



Innen
Inside
Interno
Interior
Intérieur
Ø 3 mm

Außen
Outside
Esterno
Exterior
Extérieur
Ø 4 mm

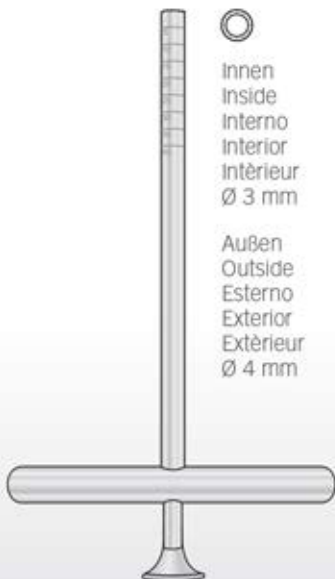

FK-92
170 mm

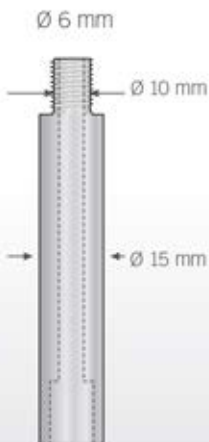

Ø 10 mm
LS-237
90 mm

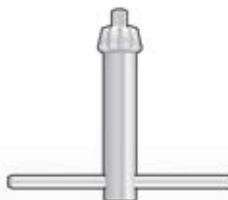

LS-241
52 mm

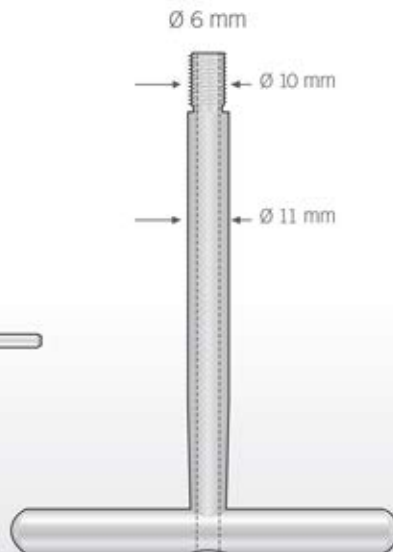

Ø 6 mm
LS-238
130 mm



Steckbohrbüchsen
 Insert-drill
 Manicotto dentato - Centrapunte
 Guía de perforación
 Guide de perçage

Ø Außen
 Ø Outside
 Ø Esterno
 Ø Exterior
 Ø Extérieur

Ø Für Bohrer
 Ø For drills
 Ø Per punte
 Ø Para brocas
 Ø Pour Mèches

Cod. Art.

LS-114	3,5 mm	2 mm
LS-115	3,5 mm	2,7 mm

LS-95

Guide Point for bone

Komplett mit
 Complete with
 Completo con
 Completo con
 Complet avec

LS-94
 LS-96
 LS-97
 LS-98

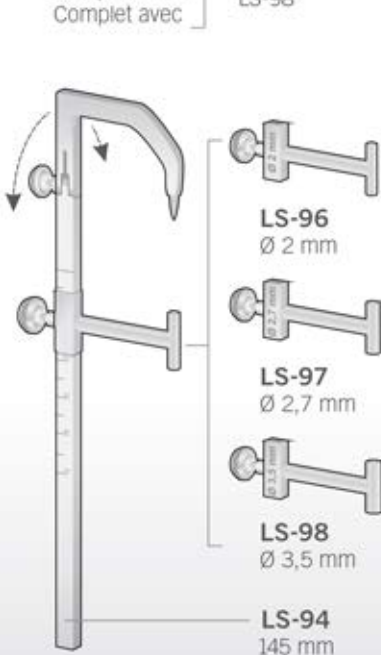

LS-96
 Ø 2 mm

LS-97
 Ø 2,7 mm

LS-98
 Ø 3,5 mm

LS-94
 145 mm

Ø Int. 1,6 mm
 Ø Est. 2,6 mm

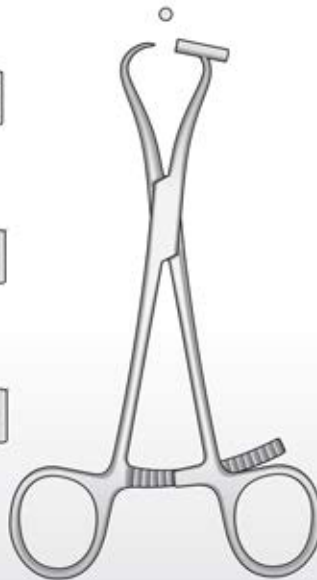

FO-242
 140 mm

Ø Int.
 2,5 mm



Ø Int.
 1,2 mm

LS-100
 120 mm

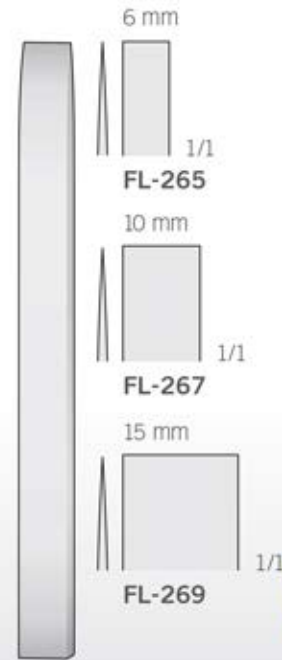

6 mm

FL-265

10 mm

FL-267

15 mm

FL-269

Zange Cerclage
 Cerclage forceps
 Pize per cerchiaggi
 Pinza para Cerclaje
 Pinces pour cerclage

TC

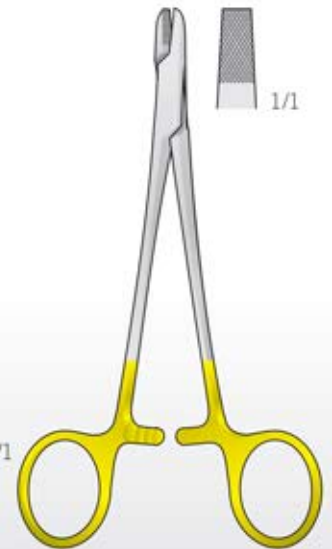

PH-58
 150 mm

LS-95

MINI-LAMBOTTE

FL-265
 170 mm



Traumatology - Orthopaedics

Traumatologie - Orthopädie

Traumatologie - Orthopédie

Traumatologia - Ortopedia

Traumatologia - Ortopedia

Löffel
Spoons
Cucchiai
Cucharillas
Cuillère

4-Hubs
4 Hubs
4 Snodi
4 Centros
4 Pôles

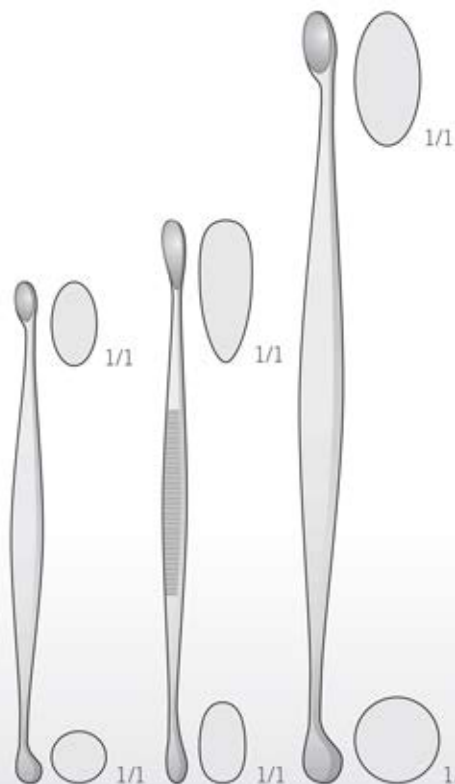

FK-177
130 mm

VOLKMANN
FK-72
145 mm

FK-178
200 mm



BEYER
FO-20
180 mm



ZAUFAL-JANSEN
FO-34
180 mm



MINI-FRIEDMANN
FO-22/FO-220
150 mm



FO-23



FO-22



FO-220



FO-24

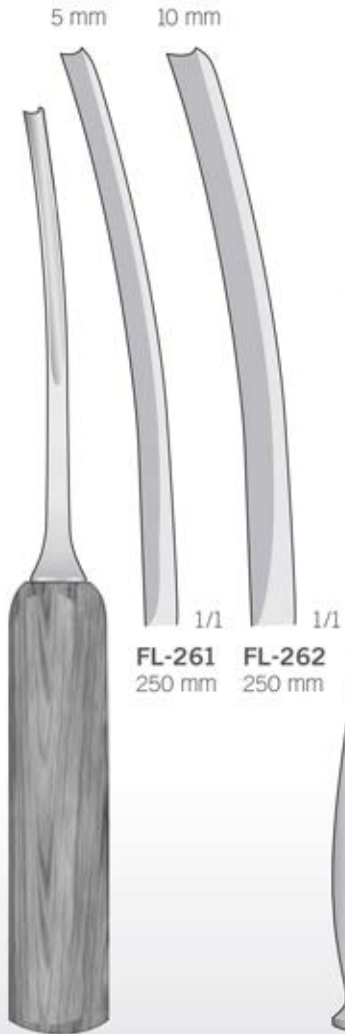

LEXER
FL-261
 250 mm

SMITH-PETERSEN
FL-359
 200 mm



Zange mit Zahnsperre
 Forceps with ratchet fixation
 Pinza con cremagliera
 Pinza con cremallera
 Davier à crémaillère

Zange mit Gewindsperre
 Forceps with thread fixation
 Pinza con regolazione
 Abrazadera ajustable
 Davier avec système d'arrêt fileté

FO-47
 140 mm

FO-48
 170 mm

FO-71
 150 mm



Traumatology - Orthopaedics

Traumatologie - Orthopädie

Traumatologie - Orthopédie

Traumatologia - Ortopedia

Traumatologia - Ortopedia



FO-62
230 mm



FO-82
250 mm



FO-105
280 mm



1/1

KERN
FO-110 170 mm
FO-112 220 mm



1/1

ULRICH
FO-84
180 mm



ULRICH
FO-62/FO-105
260 mm

Für weichen Draht Ø 5 mm
 Für harten Draht Ø 4,5 mm
 For soft wire Ø 5 mm
 For hard wire Ø 4,5 mm
 Per filo leggero Ø 5 mm
 Per filo duro Ø 4,5 mm
 Para alambre blando Ø 5 mm
 Para alambre duro Ø 4,5 mm
 Pour fil léger Ø 5 mm
 Pour fil dur Ø 4,5 mm



LX-107
375 mm

Für weichen draht Ø 2,5 mm
 Für harten draht Ø 2 mm
 For soft wire Ø 2,5 mm
 For hard wire Ø 2 mm
 Per filo leggero Ø 2,5 mm
 Per filo duro Ø 2 mm
 Para alambre blando Ø 2,5 mm
 Para alambre duro Ø 2 mm
 Pour fil léger Ø 2,5 mm
 Pour fil dur Ø 2 mm

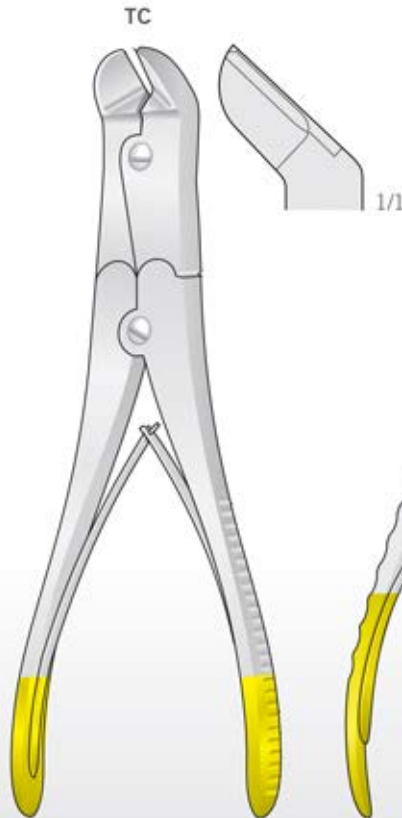

LX-105
230 mm

Für weichen draht Ø 3,5 mm
 Für harten draht Ø 2,5 mm
 For soft wire Ø 3,5 mm
 For hard wire Ø 2,5 mm
 Per filo leggero Ø 3,5 mm
 Per filo duro Ø 2,5 mm
 Para alambre blando Ø 3,5 mm
 Para alambre duro Ø 2,5 mm
 Pour fil léger Ø 3,5 mm
 Pour fil dur Ø 2,5 mm

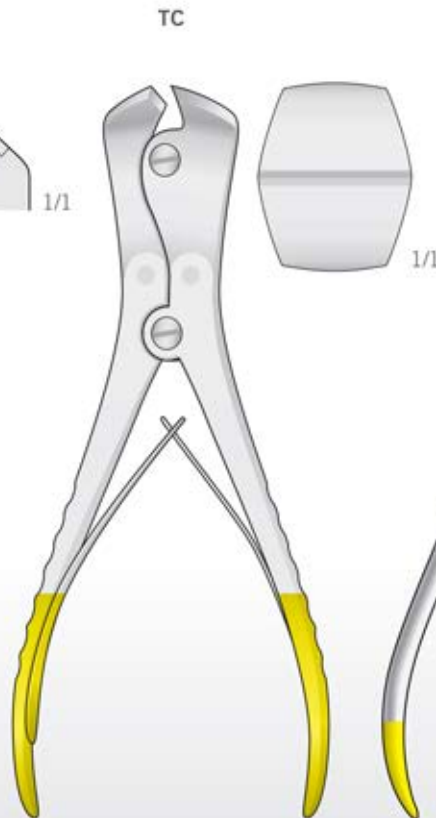

LX-104
215 mm

Traumatology - Orthopaedics
 Traumatologie - Orthopédie
 Traumatologie - Orthopédie
 Traumatologia - Ortopedia
 Traumatologia - Ortopedia



○ Max Ø 1.0 mm (.040")

Seitenschneider
 Side Cutters
 Taglio laterale
 De corte lateral
 Coupante latérale

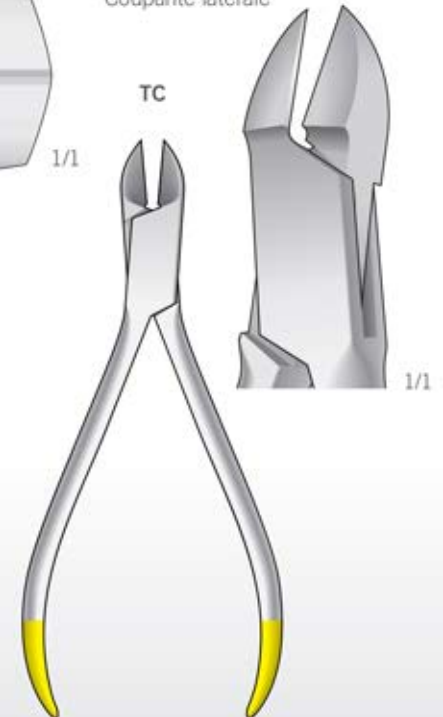

LX-96TC
150 mm



Traumatology - Orthopaedics

Traumatologie - Orthopédie

Traumatologie - Orthopédie

Traumatología - Ortopedia

Traumatologia - Ortopedia

Lange Rack
Long Rack
Cremagliera lunga
Cremallera larga
Crémaillère longue

Lange Schraube
Long Screw
Vite lunga
Tornillo largo
Vis longue

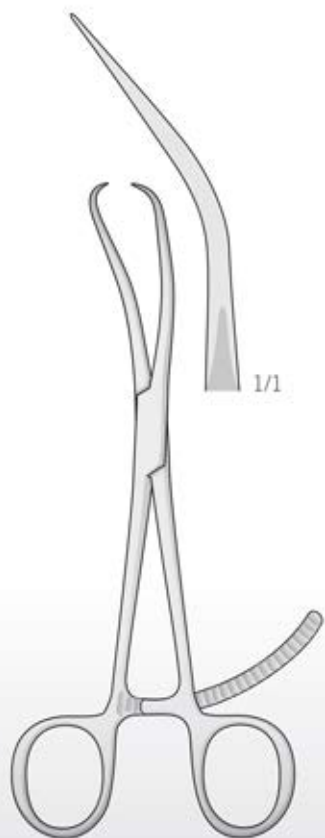

REILL
FO-64L
170 mm

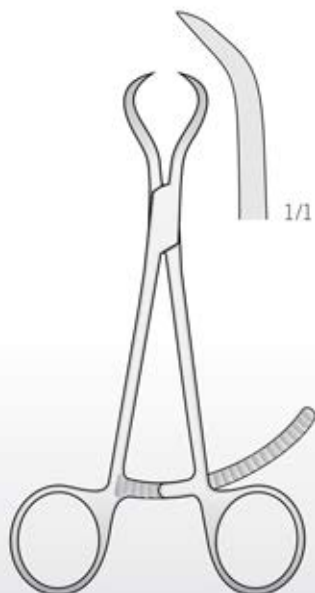

FO-66L
135 mm

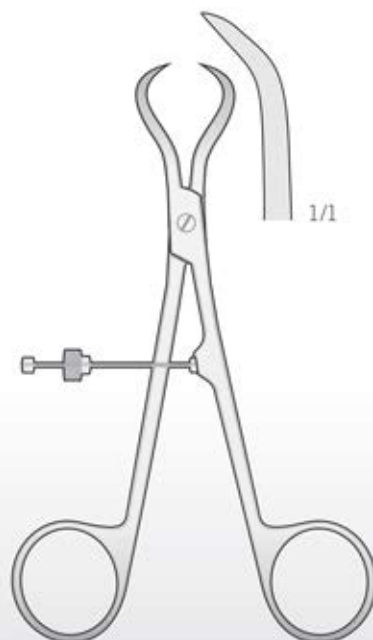

FO-79
140 mm

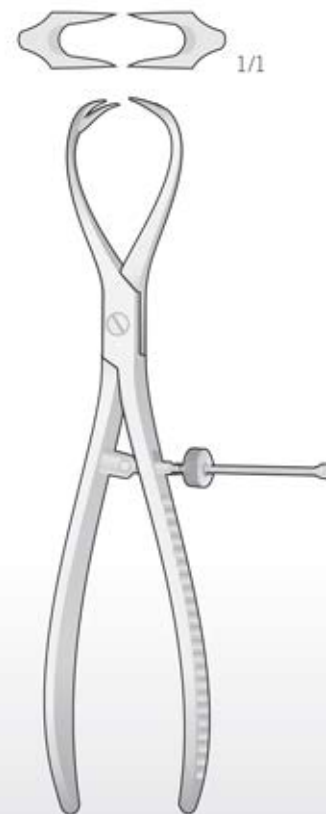

PATELLA
FO-46L
185 mm

Mit Schraubverschluss
 With screw
 Con vite di fissaggio
 Con tornillo
 Avec vis

ENT - Otolaryngology
 HNO - Heliikunde
 ORL - Oto-rhino-laryngologie
 ORL - Otorrinolaringologija
 ORL - Otorinolaringoiatria

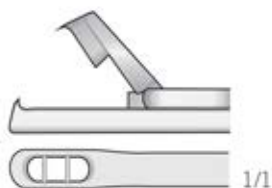

200 mm

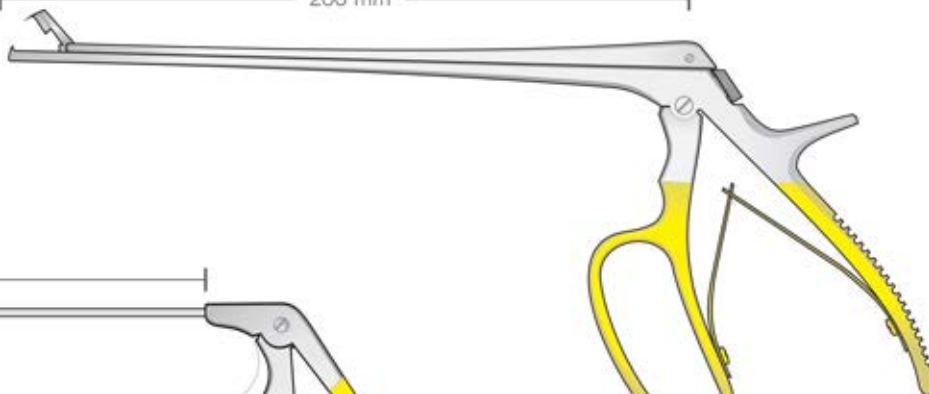

TISCHLER-MORGAN
FF-59

140 mm



Ø 3,5 mm



FF-13
 3,5 x 6,0 mm

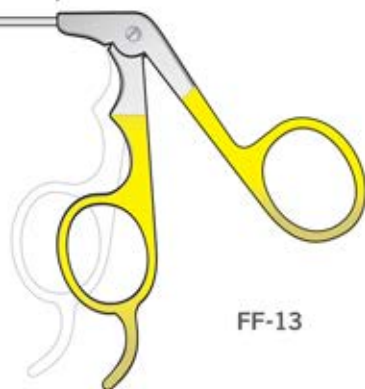

FF-13

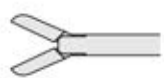

3,0 mm
 5,0 mm

125 mm

FF-13M
 3,0 x 5,0 mm

Ø 3,0 mm



2,0 mm
 3,5 mm

165 mm

FF-13MR
 2,0 x 3,5 mm

Ø 2,0 mm



FF-13M/FF-13MR



Neurosurgery
 Neurochirurgie
 Neurochirurgie
 Neurocirugia
 Neurochirurgia

**CASPAR
 FF-200M**

Distraktor Lang komplett
 Distractor Long complete
 Distrattore modificato completo

FF-201M

1 Distraktor Lang
 1 Distractor Long only

FF-202
 1 Bohrbüchse
 1 Drilling Guide

FF-203
 1 Spezialbohrer
 1 Special Drill

FF-205
 2 Distraktionsschrauben
 2 Distraction Screws

FF-206
 1 Schraubendreher
 1 Screw Driver

Spezialbohrer
 Special Drill
 Ø 1,7 mm

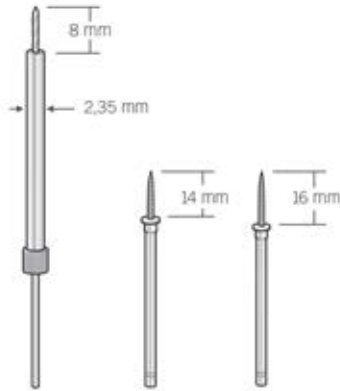

CASPAR
FF-203
 145 mm

CASPAR
FF-204
 70 mm

CASPAR
FF-205
 70 mm

Schraubendreher
 Screw Driver

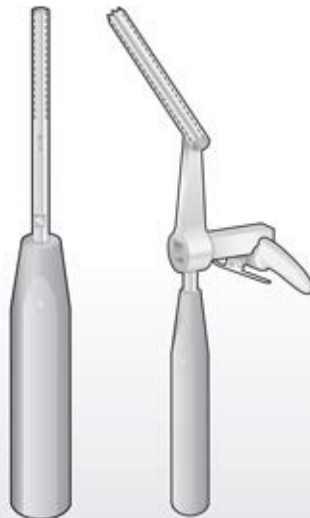

CASPAR
FF-206
 200 mm

FF-202
 Bohrbüchse
 Drilling Guide only

Dissetore per
 Neurochirurgia

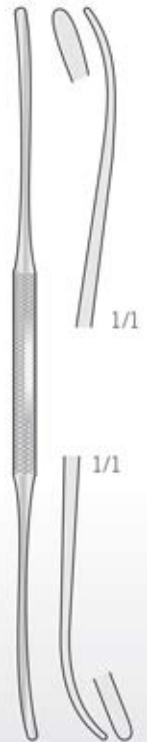

OLIVECRONA
KO-47
 180mm

STELLBRINK
FO-88/FO-89
 170 mm

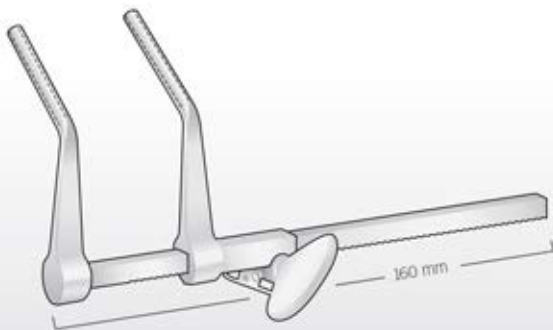

CASPAR
FF-201M
 Distraktor Lang
 Distractor Long only

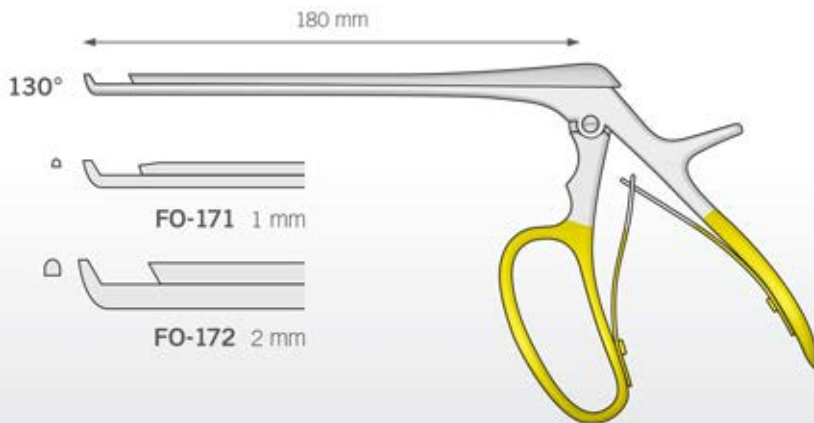
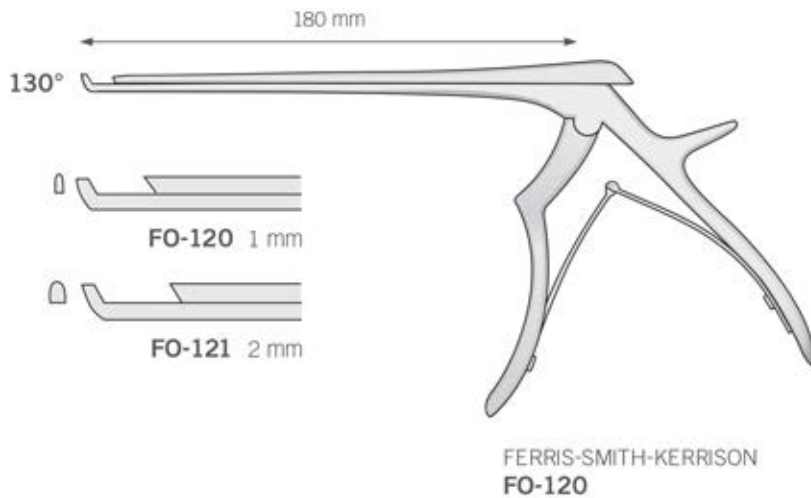

Femur-Wundspreizer
Femur Retractor
Divaricatore femorale



Femur-Wundspreizer
Femur Retractor
Divaricatore femorale



DE BAKEY
BV-315
100 mm

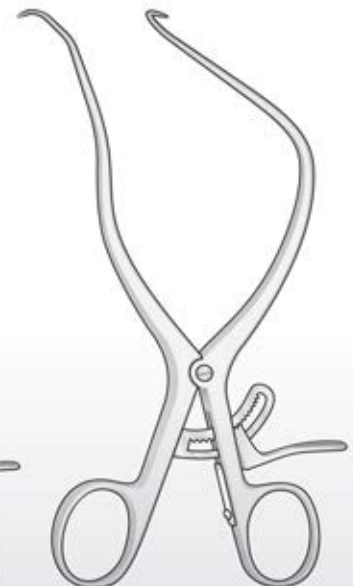

DE BAKEY
BV-316
170 mm

Palpatorischen
 Palpatory
 Palpatori
 Palpación
 Palpatoire

Schlingen
 Anses
 Anse
 Ansas
 Boucles

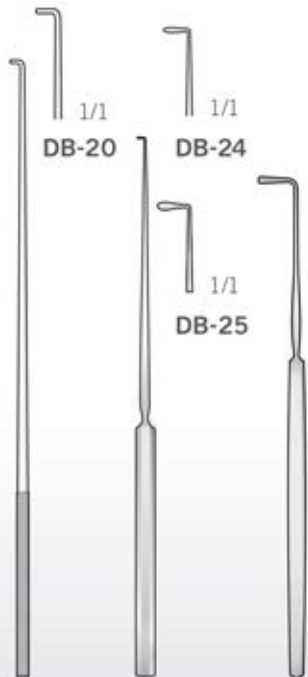

DAY
DB-20
 160 mm

LUCAE
DB-24/DB-25
 140 mm

GRAEFE
NK-245
 130 mm



713-101 **713-102**

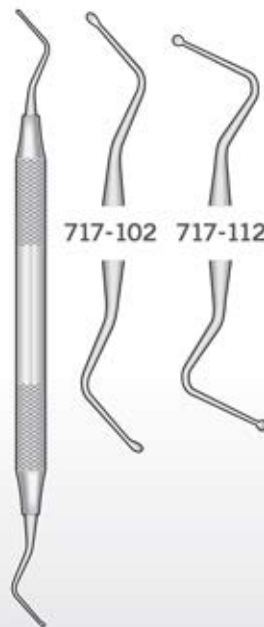

717-102 **717-112**

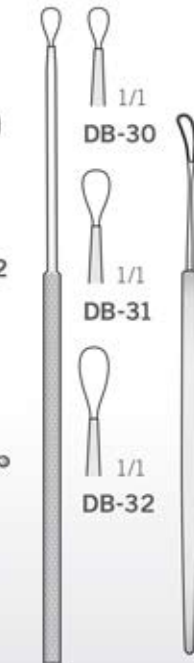

BILLEAU
DB-30
 160 mm

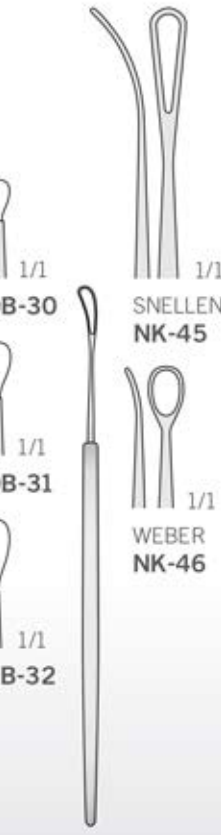

SNELLEN
NK-45/NK-46
 135 mm



AS-16
 225 mm

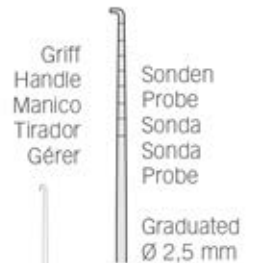

AS-19
 220 mm

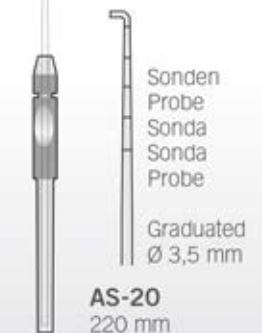

AS-20
 220 mm

Griff
 Handle
 Manico
 Tirador
 Gérer

Sonden
 Probe
 Sonda
 Sonda
 Probe

Graduated
 Ø 2,5 mm

Sonden
 Probe
 Sonda
 Sonda
 Probe

Graduated
 Ø 3,5 mm



Sharpen & Lubricate



DB-96
ARKANSAS N°8
 100 x 50 x 13 mm

What? A natural stone extracted from the mountains of Arkansas. Its shape is flat and rectangular.

Why? To sharpen all cutting parts of surgical instruments.

When? Whenever necessary to sharpen cutting parts (scissors, osteotomes, curettes, etc.).



DB-299
ARKANSAS
Conica N° 299
 Ø 8 x 90 mm

What? A natural stone extracted from the mountains of Arkansas. Its shape is cone-shaped and cylindrical.

Why? To manually sharpen internal parts of curettes, scalers, gouges, rongeurs, etc.

When? Whenever necessary to sharpen the internal parts of surgical instruments in areas that otherwise cannot be reached.



DB-4
ARKANSAS N°4
 100 x 25 x 12 mm

What? A natural stone extracted from the mountains of Arkansas. Its shape is flat and rectangular.

Why? To sharpen all cutting parts of surgical instruments.

When? Whenever necessary in routine sharpening and finishing of the edge and toe of an instrument.



DB-3
INDIA N°6
DB-6A
ARKANSAS N°6A
 100 x 45 mm

What? India stones: quarried from the finest Ozark novaculite (silicon quartz) deposits. Arkansas stone: extracted from Arkansas mountains.

Why? To manually sharpen internal parts of curettes and scalers.

When? India: for sharpening of excessively dull instruments or those requiring recontouring. Arkansas: for routine sharpening and finishing.



DB-0L
SCHARPEN OIL
 30 cc

What? A non-coloured oil, which is an indispensable complement for manual sharpening of surgical instruments.

Why? To activate the abrasive properties of all stones (Arkansas, India), and to reduce the possibility of overheating the instruments during sharpening.

When? Must ALWAYS be used during all sharpening operations.

Testing & Lubrication

What? A hard plastic test stick that can be used to test the blade of an instrument.

Why? To determine the sharpness of an instrument.

When? Always. If the blade of the instrument runs smoothly over the plastic stick, then it is blunt. A sharp instrument will grab into the stick and removes small fragments of the plastic.



DB-15
TEFLON STICK
 for testing
 Ø 8 x 100 mm

What? A high density lubricating oil of slightly red tint.

Why? To ensure perfect function and fluid movement of all surgical instruments.

When? It should be applied on all hinges or all other parts which are subject to movement or friction. Its use facilitates elimination of any residue present within the instrument hinges.



DB-0LR
RODHOIL
 Lubricant
 50 cc

Sterilisation

STERILIZATION CONTAINERS

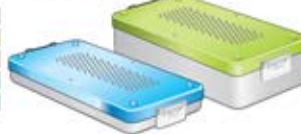

CT-555N[®] / CT-556N[®]
CT-560N[®] / CT-564N[®]
CT-565N[®] / CT-569N[®]
 300 x 140 x (40[°] / 70[°] / 100[°]) mm

STAINLESS STEEL CASSETTES

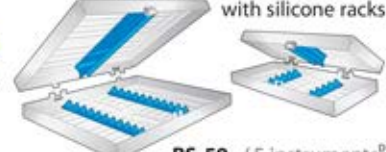

BS-59 / 5 instruments[°]
BS-60 / 10 instruments[°]
BS-61 / 20 instruments[°]
 185 x 35 x (75[°] / 135[°] / 185[°]) mm

Rinse & Clean

What? A bacteriostatic and anticorrosive detergent.

Why? Anticorrosive, bacteriostatic and lubricating action on all surgical instruments. It guarantees perfect maintenance by eliminating eventual stains, halos and browning due to sterilization, disinfection and washing with tap water.

When? Use periodically, diluted or concentrated (see special instructions on packaging).



CLEANLACT
DB-10M
 250 cc
DB-50M
 500 cc
DB-1L
 1000 cc



DB-11
 155 mm



DB-12
 175 mm

What? **DB-11** and **DB-12** are special brushes for surgical instruments.

Why? To remove eventual residue, organic or not, from all surgical instruments, in particular in angled, hinged and knurled parts, without damaging instrument surface. They are autoclavable.

When? Every time, for regular cleaning of all instrumentation and in the event that an instrument is exposed for an extended period to air before being immersed in the cleaning solution.

SPECIAL RUBBER FOR METAL

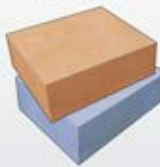

What? An abrasive eraser specially designed for surgical instruments.

Why? To remove stains, halos or persistent burnishing from all surgical instruments without damaging the instrument surface.

When? Necessary when routine cleaning does not remove all stains.

Alphanumerical index
 Nummernverzeichnis
 Index alphanumerique
 Índice alfanumérico
 Índice alfanumérico



1	24	BD-157	10	CU-1/2	25	EA-10	12	FK-72	40	FM-318	8	LB-365	29	NK-47	29	PH-107	17
30	24	BD-250	9	CU-3/4	25	EA-11	12	FK-92	38	FM-319	8	LB-367	29	NK-48	29	PH-122	16
49	24	BD-274	10	DA-01	22	EA-13	12	FK-177	40	FM-328	8	LK-4	3	NK-66	31	PH-127	16
56	24	BD-371	9	DA-02	22	EA-14	12	FK-178	40	FM-337	7	LS-94	39	NK-69	31	PO-34	18
713-101	48	BEIN-2	23	DB-07	49	EA-50	12	FK-194	35	FM-343	6	LS-95	39	NK-80	27	PO-35	18
713-102	48	BEIN-2Z	23	DB-08	49	EA-51	12	FK-199	35	FO-20	40	LS-96	39	NK-82	27	PO-36	18
715-102	26	BEIN-3	23	DB-1L	49	EA-53	12	FK-243	36	FO-22	40	LS-97	39	NK-84	27	PO-50	18
715-103	26	BEIN-4	23	DB-3	49	EA-54	12	FL-10M	33	FO-23	40	LS-98	39	NK-86	27	PO-51	18
717-100	48	BF-38	11	DB-4	49	FB-16	13	FL-84	37	FO-24	40	LS-100	39	NK-245	48	PO-52	18
717-102	48	BF-40	11	DB-6A	49	FB-255	28	FL-85	37	FO-34	40	LS-114	39	NK-274	29	PO-66	18
717-112	48	BF-41	11	DB-10M	49	FB-256	13	FL-86	37	FO-46L	44	LS-115	39	OL-07	15	PO-86	18
718-277	25	BF-42	11	DB-11	49	FD-11	27	FL-87	37	FO-47	41	LS-222	38	OL-08	15	PO-95	18
718-M23	25	BF-44	11	DB-12	49	FD-41	27	FL-88	37	FO-48	41	LS-224	38	OL-22	15	PO-98	18
718-M23A	25	BF-48	11	DB-15	49	FD-42	27	FL-89	37	FO-62	42	LS-227	38	OL-31	15	PO-100	18
718-M23B	25	BF-64	5	DB-20	48	FD-64	27	FL-152	15	FO-64L	44	LS-228	38	OL-32	15	R-2	26
719-111	25	BM-01	16	DB-24	48	FD-65	27	FL-261	41	FO-66L	44	LS-236	38	OL-33	15	R-3	26
AS-10	48	BM-02	16	DB-25	48	FD-66	27	FL-262	41	FO-71	41	LS-237	38	OL-36	15	RH-4	22
AS-16	48	BM-03	16	DB-30	48	FD-67	27	FL-265	39	FO-79	44	LS-238	38	OL-40	15	SC-1	5
AS-19	48	BM-04	16	DB-31	48	FD-68	27	FL-267	39	FO-82	42	LS-241	38	OL-50	29	SC-9	5
AS-20	48	BM-17	33	DB-32	48	FD-105	28	FL-269	39	FO-84	42	LS-320	38	OM-09	29	SC-13	5
BB-46	29	BN-502	19	DB-50M	49	FD-106	28	FL-286	37	FO-88	46	LX-80	32	OR-12	27	SD-M	21
BD-10	10	BS-59	49	DB-96	49	FD-107	28	FL-287	37	FO-89	46	LX-96TC	43	OR-17	27	SM-11	22
BD-16	10	BS-60	49	DB-114	14	FD-108	28	FL-288	37	FO-105	42	LX-98	21	P-24	11	SM-13	22
BD-18	10	BS-61	49	DB-120	14	FD-109	28	FL-289	37	FO-110	42	LX-104	43	P-34	11	US DL-401	20
BD-27	10	BT-05	36	DB-121	14	FD-110	28	FL-359	41	FO-112	42	LX-105	43	P-50	13	US DL-402	20
BD-28	10	BT-18	33	DB-122	14	FF-13	45	FM-1	4	FO-120	47	LX-107	43	P-52	13	US DL-403	20
BD-30	9	BT-19	33	DB-299	49	FF-13M	45	FM-2	4	FO-121	47	LX-131	33	P-91	11	US DL-500	20
BD-31	9	BT-98	37	DB-940	19	FF-13MR	45	FM-3	4	FO-171	47	MA-2	22	P-92	11	VF-102	15
BD-32	30	BV-04	27	DB-941	19	FF-59	45	FM-3F	4	FO-172	47	MC-11	25	P-100	13	VF-102M	15
BD-33	30	BV-06	27	DB-942	19	FF-200M	46	FM-4	4	FO-220	40	MC-12	25	P-120	28	VF-120	20
BD-35	30	BV-11	35	DB-0L	49	FF-201M	46	FM-4F	4	FO-242	39	MC-13	25	P-121	28	VF-121	20
BD-36	30	BV-13	35	DB-0LR	49	FF-202	46	FM-12	3	FREER	21, 36	MF-200	31	P-193	13	VF-122	20
BD-42	10	BV-14	34	DL-05	22	FF-203	46	FM-66	6	GF-09	14	MF-201	31	P-266	11	VF-126	20
BD-56	30	BV-14M	34	DL-06	22	FF-204	46	FM-67	6	GF-22	14	MF-205	31	P-267	11	VF-127	20
BD-57	30	BV-15	34	DL-58	33	FF-205	46	FM-68	6	GF-29	14	MF-206	31	PEB-1	24	VH-20	32
BD-58	30	BV-16	34	DL-78	22	FF-206	46	FM-69	6	GF-75	14	MIR-12	20	PEB-2	24	VH-21	32
BD-59	30	BV-108	34	DL-79	22	FG-11C	6	FM-100	7	GF-76	14	MO-8	26	PEB-3	24	VH-48	21
BD-73	9	BV-109	34	DL-102	23	FG-21C	6	FM-102	7	GF-77	14	MO-10	26	PEB-5	24	VH-49	21
BD-80	10	BV-315	47	DL-103	23	FG-10	3	FM-104	7	KO-47	46	NK-21	29	PF-19	15	VH-50	21
BD-92	9	BV-316	47	DL-112	23	FG-31	5	FM-180	3	L-21	21	NK-22	29	PF-22	15	VH-51	21
BD-130	30	CT-555N	49	DO-63	36	FG-32	5	FM-296	8	L-26	21	NK-23	29	PH-58	39	WG-12	36
BD-131	30	CT-556N	49	DO-267	36	FG-209	26	FM-297	8	L-27	21	NK-24	29	PH-65	17	WG-14	36
BD-132	30	CT-560N	49	DP-41	32	FG-210	26	FM-300	8	L-28	21	NK-25	29	PH-72	16		
BD-135	31	CT-564N	49	DP-84	32	FK-48	37	FM-301	8	L-29	21	NK-26	29	PH-75	16		
BD-136	31	CT-565N	49	DR-50	21	FK-49	37	FM-306	7	LB-361	29	NK-45	48	PH-85	17		
BD-141	9	CT-569N	49	DR-60	21	FK-51	37	FM-308	8	LB-364	29	NK-46	29, 48	PH-102	17		

EN / Graphic images in our Catalogue are for references only and not binding. We reserve the right to modify aesthetically and technically without prior notice. To reprint this catalogue – or any part of it – without our final approval, is prohibited.

DE / Die Abbildungen in unseren Katalogen sind nicht bindend für unseren Betrieb. Wir behalten uns das Recht auf Änderungen in Aussehen und Abmessungen vor, ohne vorherige Ankündigung. Der Nachdruck des Kataloges – auch auszugsweise – ist ohne unser ausdrückliches Einverständnis untersagt. Geschmacksmusterangemeldet.

FR / Les images graphiques dans les catalogues sont à titre de référence. Nous réservenons le droit de modifier de façon technique et/ou esthétique sans préavis. Toute reproduction totale ou partielle de ce catalogue – sans notre accord – est interdite.